



# PET-AR400 User Manual

November 2022, V1.0.0



Written by Edward Ku

Edited by Anna Huang

## **Warranty**

---

All products manufactured by ICP DAS are under warranty regarding defective materials for a period of one year, beginning from the date of delivery to the original purchaser.

## **Warning**

---

ICP DAS assumes no liability for any damage resulting from the use of this product. ICP DAS reserves the right to change this manual at any time without notice. The information furnished by ICP DAS is believed to be accurate and reliable. However, no responsibility is assumed by ICP DAS for its use, not for any infringements of patents or other rights of third parties resulting from its use.

## **Copyright**

---

Copyright

© 2022 by ICP DAS Co., Ltd. All rights are reserved.

## **Trademark**

---

The names used for identification only may be registered trademarks of their respective companies.

## **Contact US**

If you have any problem, please feel free to contact us.  
You can count on us for quick response.

Email : [service@icpdas.com](mailto:service@icpdas.com)

# Table of Contents

Table of Contents .....	3
1. Introduction.....	5
1.1. Features .....	6
1.2. Specification .....	12
1.2.1. System Specification .....	12
1.2.2. I/O Specification .....	13
1.3. Overview.....	14
1.4. Block Diagram.....	16
1.5. Dimension.....	17
2. Getting Started .....	18
2.1. Checking the Package Contents .....	18
2.2. Mounting the PET-AR400 .....	19
2.3. Powering on and Connecting to the PET-AR400 .....	21
2.4. Installing the HSDAQ Utility.....	23
2.5. Assigning an IP address .....	24
2.6. Acquiring and Analyzing Data.....	27
3. Data Acquisition Modes .....	31
3.1. Continuous Acquisition.....	32
3.2. N-Sample Acquisition .....	33
4. Web Applications.....	34
4.1. Overview.....	36
4.2. Configuration.....	37
4.2.1. Network Settings .....	37
4.2.2. Basic Settings .....	38
4.3. Authentication.....	44
4.3.1. Accounts Management.....	44
4.3.2. IP Filter .....	47

4.4. More Information .....	50
5. Modbus Application .....	51
5.1. Modbus/TCP Interface.....	52
5.2. Modbus/TCP Data Frame .....	52
5.3. Modbus Register Map .....	54
6. Software and Tools.....	56
6.1. LabVIEW.....	56
6.2. HSDAQ Utility.....	57
6.3. PET-AR400 SDKs.....	58
7. Updates .....	59
8. Calibration .....	62
Appendix.....	65
A. Analog Input Type and Data Format .....	65
B. Troubleshooting .....	66
C. Applications .....	67
C.1. Raspberry Pi Application .....	67
C.2. Vibration High Speed Measurement Application.....	68
D. Revision History.....	69

# 1. Introduction

The PET-AR400 is a high speed data acquisition device. The PET-AR400 built-in an Ethernet communication port for data transfer over the network and includes 4 IEPE inputs (128 kHz for 1 channel; 32 kHz for 4 channels) for measuring the signal from an IEPE accelerometer.

The PET-AR400 also provides 4 kV ESD protection as well as 2500 VDC intra-module isolation. In addition, the 24-bit ADC includes built-in Sinc3 filtering to adjust the appropriate sampling rate and filter out modulator and signal noise.

The PET-AR400 is not only suitable for a wide range of mobile/portable measurement applications, but also for precision signal measurement.

PET-AR400 supports many kinds of trigger modes for A/D conversion : software trigger, analog threshold trigger. The software trigger can acquire a sample whenever needed; The analog threshold trigger will collect data while the analog input value is higher or lower than specific voltage value.

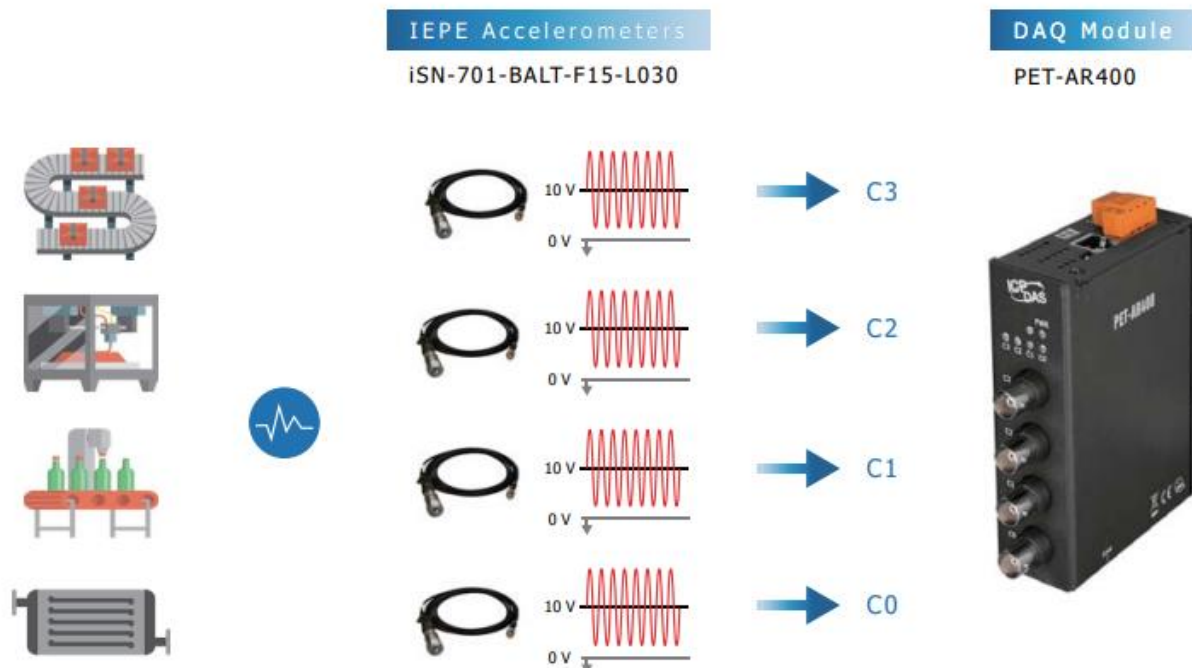

## 1.1. Features

The PET-AR400 module offers the most comprehensive configuration to meet specific application requirements. The following list shows the features designed to simplify installation, configuration and application.

### • Data Acquisition Mode

---

#### 1. Continuous Acquisition Mode

After starting A/D acquisition, data is continuously transmitted to the Host PC.



#### 2. N-samples Acquisition Mode

- a. After starting A/D acquisition, the data will be temporarily stored in the memory and wait until the host PC send a transmit command, once the module received the command, it start transferring data to the host PC.
- b. The memory capacity allows temporary storage of up to 15 million data samples.

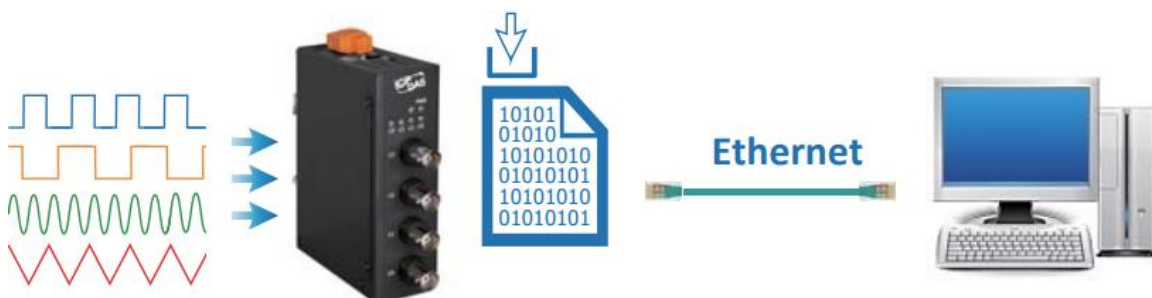

## • A/D Trigger Mode

### 1. Software trigger mode

After the acquisition parameters are configured by the PC and the trigger command is send, the A/D starts to acquire data.

### 2. Analog threshold trigger mode

After the acquisition parameters are configured by the PC and the start command is send, the A/D waits for the input voltage signal to meet the trigger condition, after the signal reach the condition, it starts to collect data

The analog threshold trigger can be used to detect the instantaneous change in a continuous voltage signal.

The user can specify the trigger condition and range.

1. Above High : A/D starts to acquire data, once the signal is higher than the high level.
2. Below Low : A/D starts to acquire data, once the signal is lower than the high level.

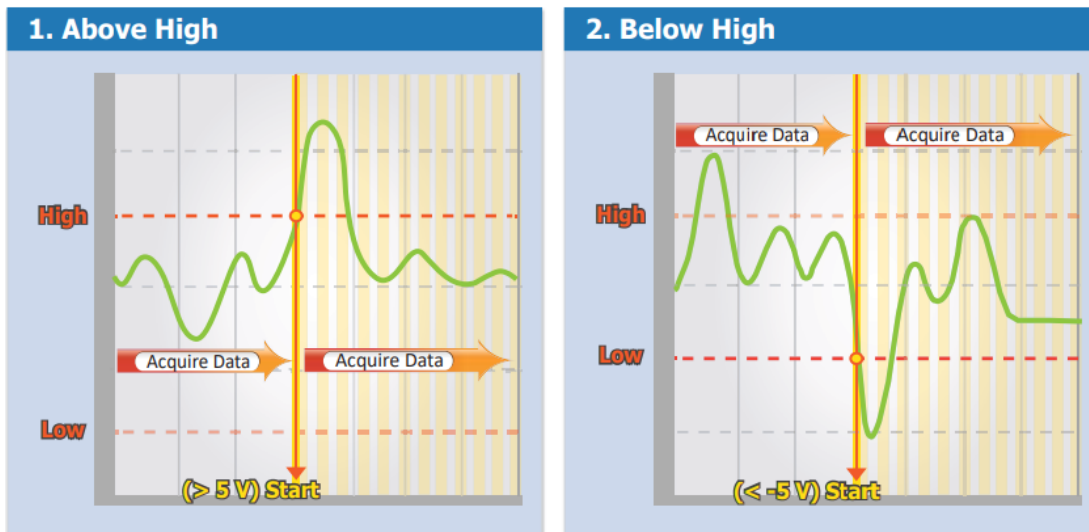

3. Leave-region : A/D starts to acquire data, once the signal is out of range.

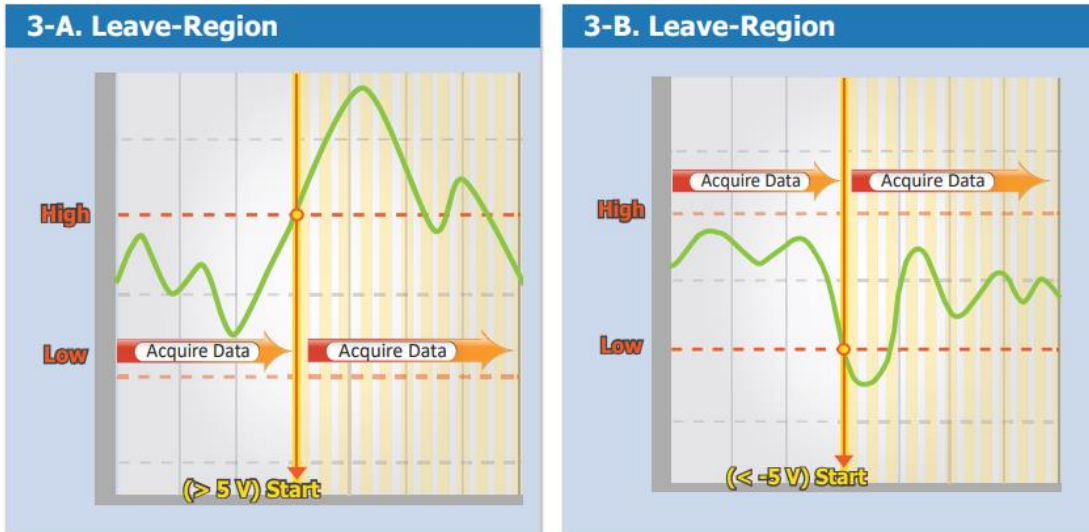

4. Entry-region : A/D starts to acquire data, once the signal is in the range.

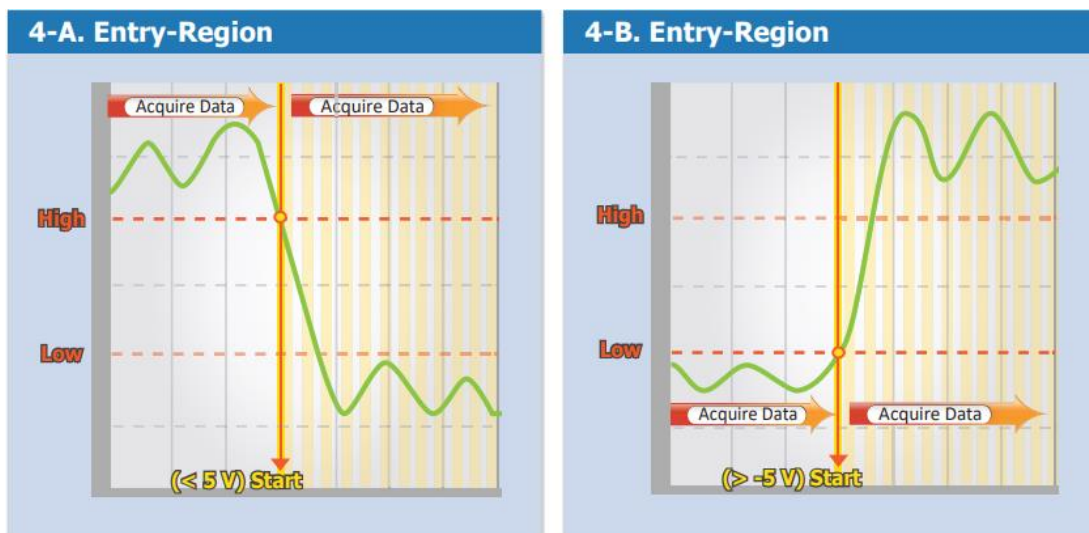

#### • Modbus/TCP Protocol

---

The Modbus/TCP slave function on the Ethernet port can be used to provide data to remote HMI/SCADA software built with Modbus/TCP driver.

#### • Automatic MD/MDI-X Crossover for Plug-and-play MDI/MDI-X

---

RJ-45 port supports automatic MDI/MDI-x that can automatically detect the type of connection to the Ethernet device without requiring special straight or crossover cables.



## • Built-in Web Server

---

Each PET-AR400 module has a built-in web server that allows users to easily configure, monitor and control the module from a remote location using a regular web browser

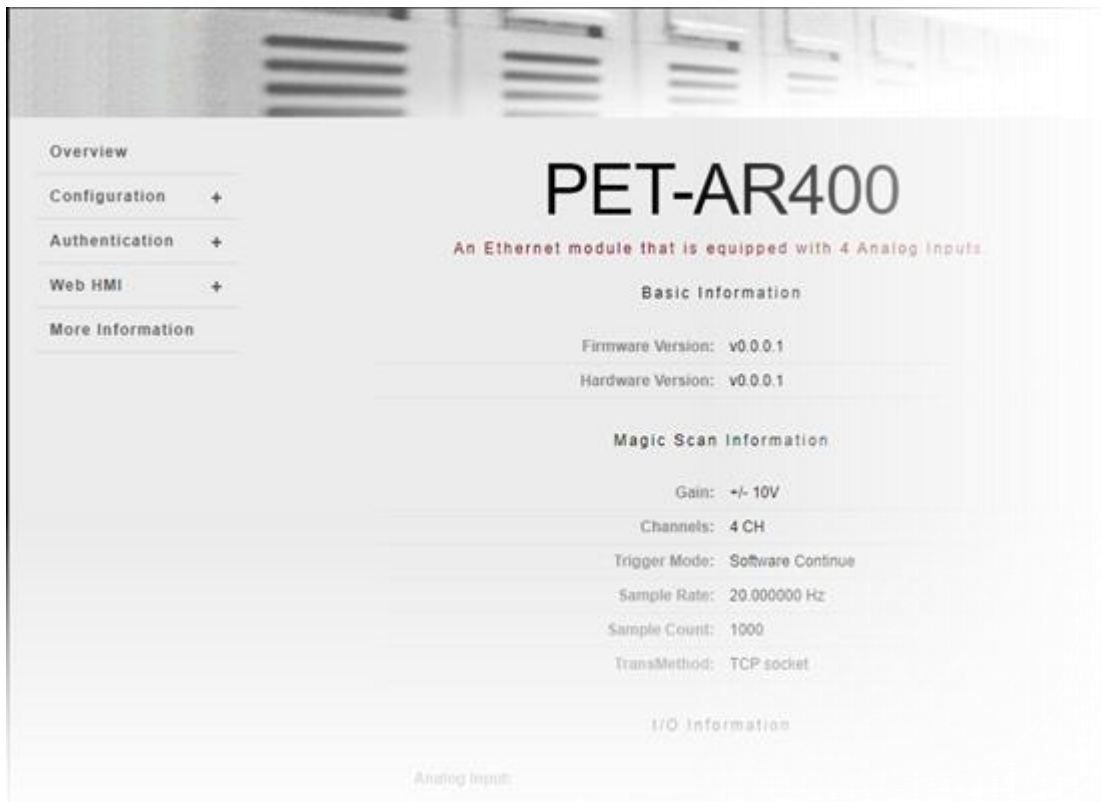

## • Communication Security

---

Account and password are required when logging into the PET-AR400 web server. An IP address filter is also included, which can be used to allow or deny connections with specific IP addresses.

## • Software Support

---

### 1. Supported Operating Systems

Windows 7/8/10 and Linux

### 2. Software Compatibility

Microsoft VC, C#,VB.NET SDK API and Demo

NI LabVIEW Toolkit and Demo

C/C++ Library and Demo for Linux

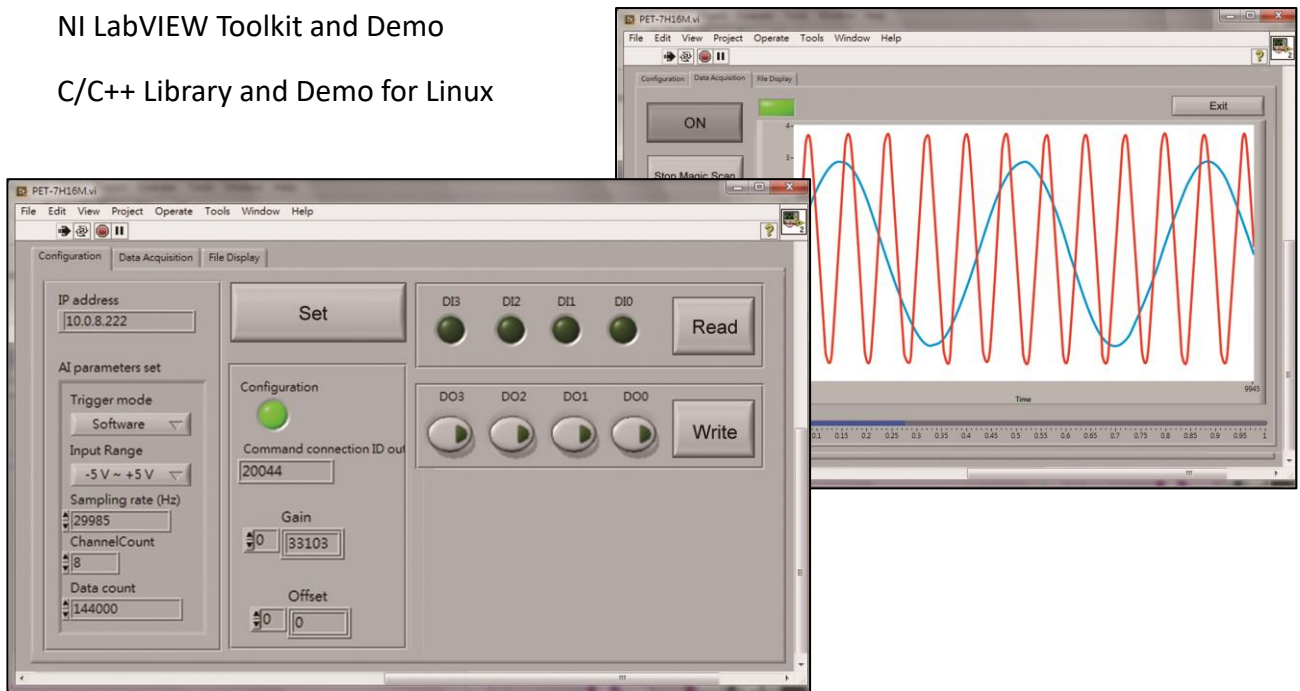

## • Highly Reliable Under Harsh Environment

---

PET-AR400 is housed in a metal shell/case with a column-like ventilator that helps to cool the working environment inside the shell/case.

- Operating Temperature : -25 ~ +75 °C
- Storage Temperature : -30 ~ +80 °C
- Humidity : 10 ~ 90 % RH (non-condensing)

- PoE

---

PET-AR400 feature true IEEE 802.3af-compliant (classification, Class 2) Power over Ethernet (PoE) using both Ethernet pairs (Category 5 Ethernet cable), it allows power and data to be carried over a single Ethernet cable, so a device can operate solely from the power it receives through the data cable.

This innovation allows greater flexibility in office design, higher efficiency in systems design, and faster turnaround time in set-up and implementation.

The PET-AR400 can receive power from an auxiliary power sources like AC adapters and battery in addition to the PoE enabled network.

This is a desirable feature when the total system power requirements exceed the PSE's(power sourcing equipment) load capacity. Furthermore, with the auxiliary power option, PET-AR400 can be used in a standard Ethernet (non-PoE) system.

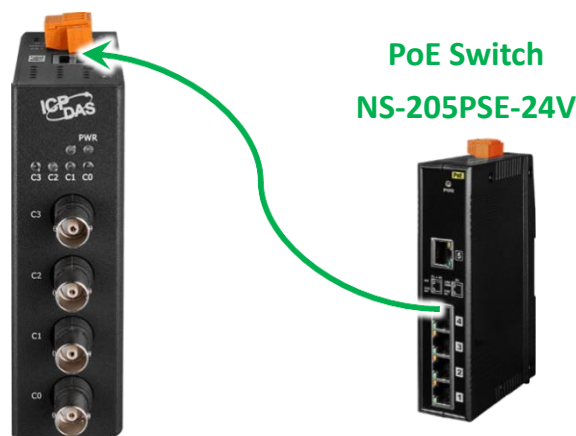

When using PoE devices like PET-AR400, user can choose ICP DAS“PoE switch” —“NS-205PSE-24V”as the power source, it can automatically detect the connected devices whether they are PoE devices. This mechanism ensures NS-205PSE-24V to work with both PoE and non-PoE devices coordinately at the same time.

## 1.2. Specification

The table below summarizes the specifications of the PET-AR400.

### 1.2.1. System Specification

Software	
OS	Windows 7/8/10 and Linux
Utility	Configuration, graphically display and data logging
SDK	<b>Windows</b> Microsoft VC, C#, VB.NET SDK API and Demo Python Demo NI LabVIEW Toolkit and Demo <b>Linux</b> C/C++ library and Demo .NET library and Demo Python Demo
Communication	
Ethernet Port	1 x RJ-45, 10/100 Base-TX(Auto-negotiating, Auto MDI/MDI-X)
PoE	Yes,IEEE 802.3af,class 2
Security	ID, Password and IP Filter
Protocol	TCP Streaming (Access data by SDK library), Modbus TCP
LED Indicators	
Status	Power, 4 x Connection
2-Way Isolation	
I/O	2500 VDC
EMS Protection	
ESD(IEC 61000-4-2)	4 kV Contact for Each Terminal and 8 kV Air for Random Point
EFT (IEC 61000-4-4)	1 kV for Power
Power	
Reverse Polarity Protection	Yes
Powered from Terminal Block	+12 ~ +48 VDC
Consumption	4.5 W (Max.)

Mechanical	
Dimensions (W x L x H)	76 mm x 120 mm x 38 mm
Installation	DIN-Rail or Wall Mounting
Enclosures	Metal
Environment	
Operating Temperature	-25 ~ +75 °C
Storage Temperature	-30 ~ +80 °C
Humidity	10 ~ 90 % RH, Non-condensing

### 1.2.2. I/O Specification

IEPE Input	
Channels	4 Differential (Simultaneously)
Range	+/-10 V
Resolution	24-bit
Accuracy	+/- 0.02 % of FSR @ +/-10V
Sampling Rate	32 kHz @ 3/4 channels 64 kHz @ 2 channels 128 kHz @ 1 channel
Input Impedance	2M Ohm
FIFO Size	1 k bytes, 256 Samples
Trigger Mode	Software, Analog Threshold Trigger
Excitation Current	4 mA (IEPE compliance : 24 V)
Input Common Mode Range	+/-10 V
Input coupling	AC coupling
Cutoff frequency	0.16 Hz
Input Bandwidth	12.8 kHz (-0.1 db) @ 1/2 channel(s) 6.4 kHz (-0.1 db) @ 3/4 channels
Connectors	BNC (female)

# 1.3. Overview

PET-AR400 is equipped with several interfaces and peripherals that can be integrated with external systems. Here is an overview of the components and its descriptions.

## • LED Indicators

PET-AR400 has 2 system LED indicators and 4 I/O LED indicators. The table below shows the definition of each LED indicator.

LED	Status	Definition
PWR	ON	When power on
	OFF	When power off
C0 ~ C3	ON	When connected
	OFF	When disconnected

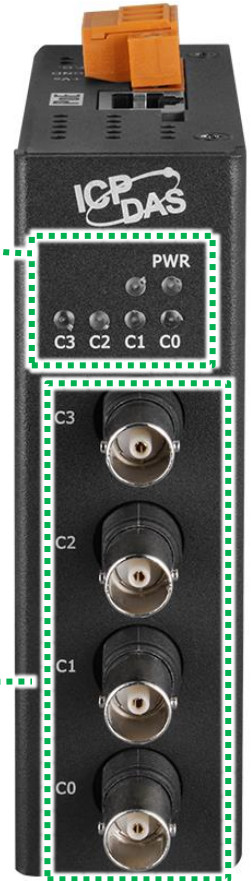

## • IEPE Input

PET-AR400 has 4 IEPE input channels, the IEPE input uses a BNC adapter (female), and only needs to connect the BNC adapter (male) when wiring.

## • PoE Port

PET-AR400 has a PoE port that can power to PET-AR400 over the Ethernet cable. This eliminates the need for separate power cables and allows for easier installation and maintenance of the PET-AR400.

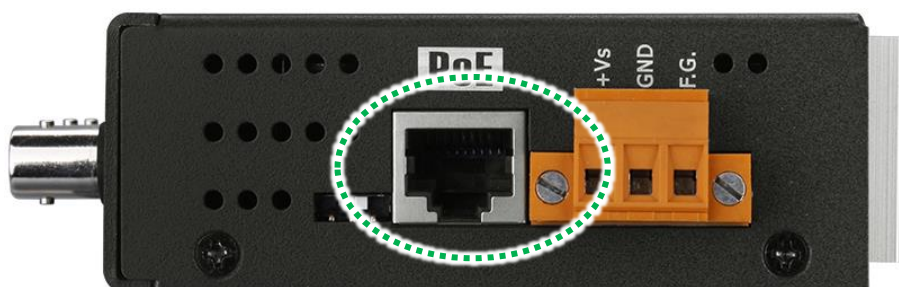

## • Reset Button

---

The PET-AR400 has a reset button on the bottom of the PET-AR400. This reset button can be pressed to reset the PET-AR400 to its default settings.

If the reset button is pressed for at least 5 seconds, the PET-AR400 will perform a factory reset and reboot.



The table below shows the factory default settings for PET-AR400.

Items		Default Settings
Network Settings	IP Address	192.168.255.1
	Gateway	192.168.0.1
	Mask	255.255.0.0
	DHCP	Disable
Gain/offset value		Default
Account Management	Account	Admin
	Password	Admin
IP Filter		None

## 1.4. Block Diagram

The block diagram of the PET-AR400 system is shown below.

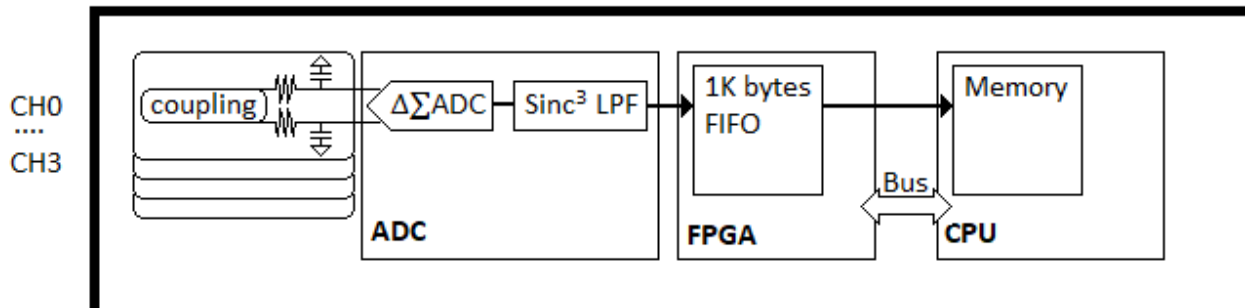



## 1.5. Dimension

The dimensions of the PET-AR400 are shown below. All dimensions are in millimeters.

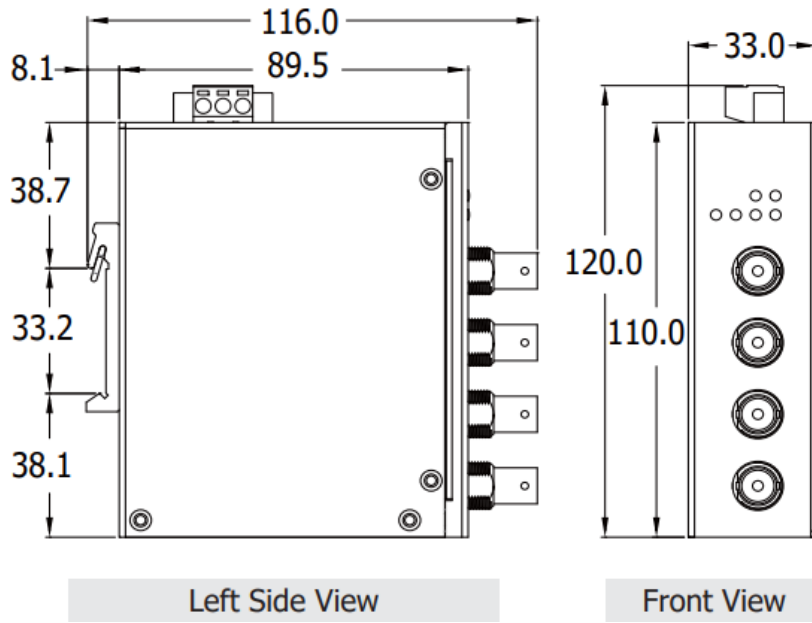

## 2. Getting Started

If you are a new user, begin with this chapter, it includes a guided tour that provides a basic overview of installing, configuring and using the PET-AR400.

Before working with the PET-7H24M, you should have a basic understanding of hardware specification, such as the dimensions, the usable input-voltage range of the power supply, and the type of communication interfaces

For more information about the hardware details, please refer to section “1.2. Specification”.

For more information about the hardware dimensions, please refer to section “1.5. Dimension”.

### 2.1. Checking the Package Contents

Before starting any task, please confirm that the package contents are complete and undamaged. If there is any missing or damaged part, please contact your product dealer or distributor.

The package contents of this product are as follows:



**PET-AR400**



**Quick Start Guide**



**2.4 mm Screw Driver**

## 2.2. Mounting the PET-AR400

PET-AR400 comes with a guide rail clip that makes it easy to install on a standard 35 mm DIN rail.

**Step 1 : Hook the upper tab over the upper flange of the DIN-Rail**

**Step 2 : Tilt the module toward the DIN-Rail until it snaps securely to rail**

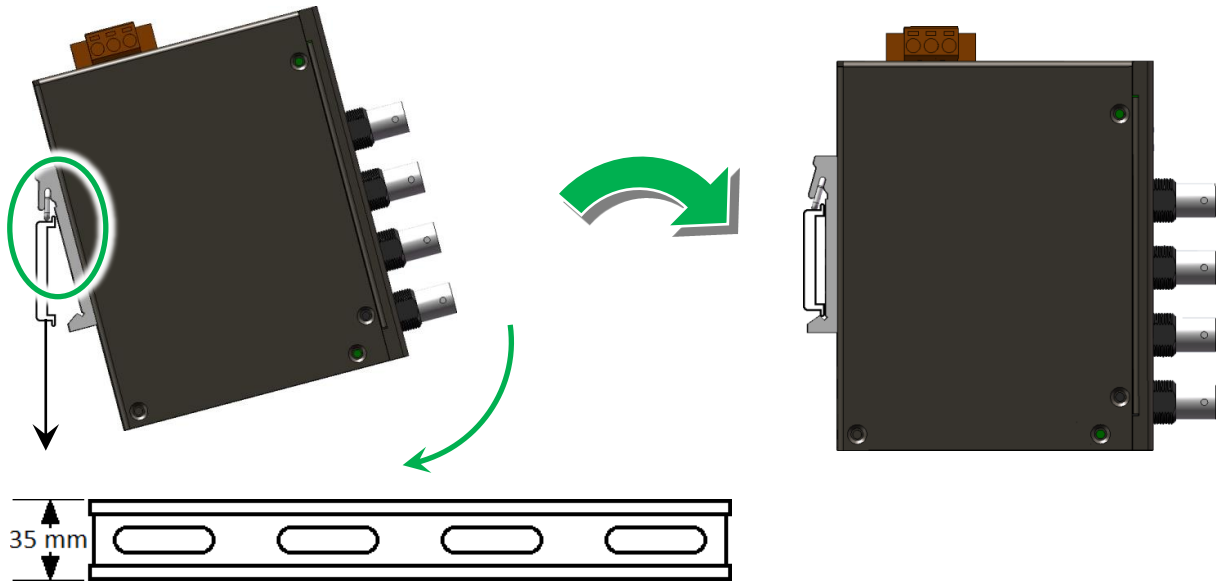

### Tips & Warnings



**To remove the module from DIN-Rail**

Gently press down on the module and then pull the bottom of the module away from the DIN-rail clip to remove it.

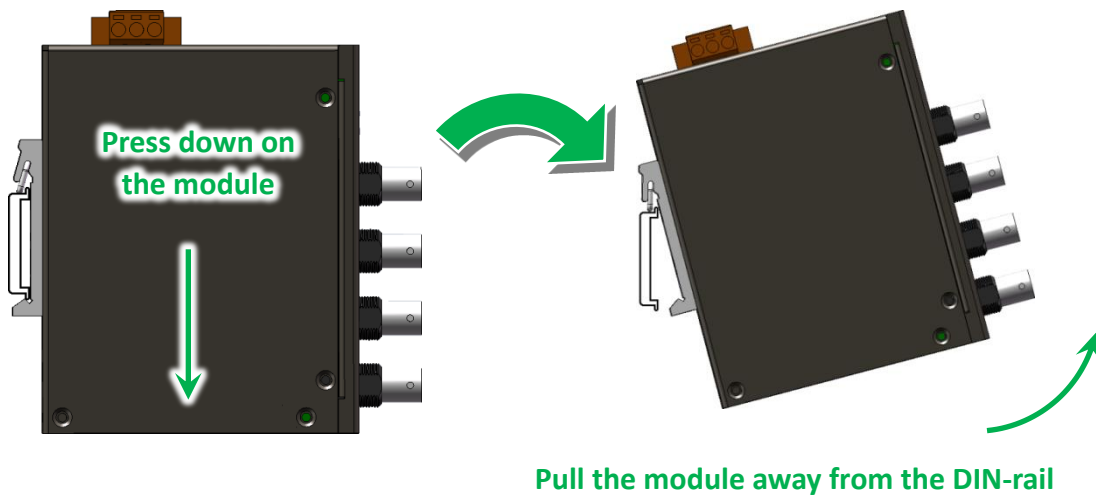

### Step 3 : Mount the ground screw and wiring the ground cable

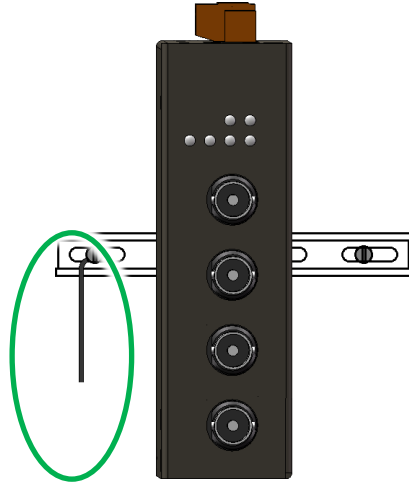

---

#### Tips & Warnings



A good ground reference (earth ground) is essential for proper operation of the PET-AR400. One side of all control circuits, power circuits and the ground lead must be properly connected to earth ground by either installing a ground rod in close proximity to the enclosure or by connecting to the incoming power system ground. There must be a single-point ground (i.e. copper bus bar) for all devices in the enclosure that require an earth ground.

---

## 2.3. Powering on and Connecting to the PET-AR400

There are two ways to power on the PET-AR400, either through a PoE switch or an external power source.

### Tips & Warnings

---



- The external power supply should be within the range of +12 ~ +48 VDC.
  - PET-AR400 is equipped with a power indicator to check the power supply status.
- 

### Power on the PET-AR400 through a PoE switch

- i. Connect the PET-AR400 to the PoE switch via the Ethernet cable.
- ii. Connect the PC to the PoE switch via the Ethernet cable.
- iii. Wire the power supply to the PoE Switch

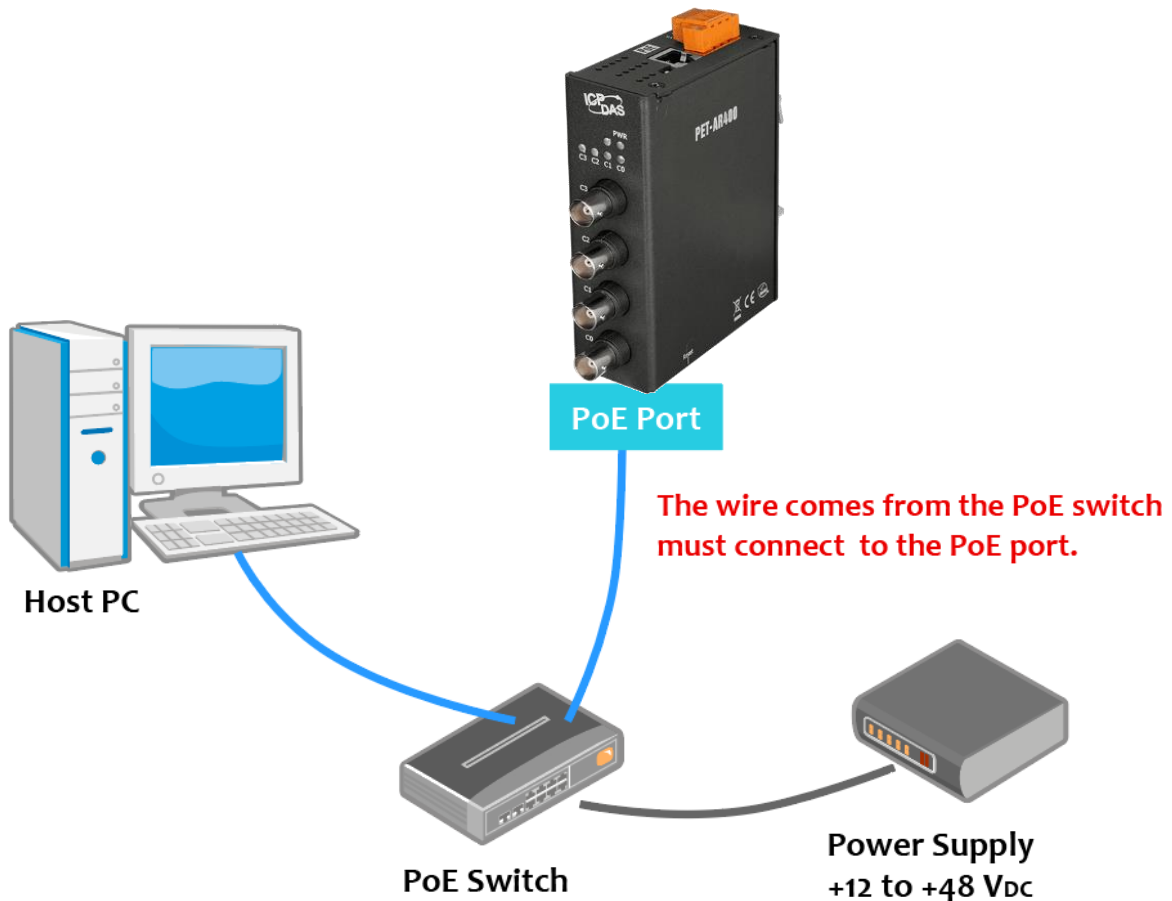

## Power on the PET-AR400 through an external power source

- i. Connect the PET-AR400 to the switch via the Ethernet cable.
- ii. Connect the PC to the switch via the Ethernet cable.
- iii. Wire the power supply to the PET-AR400.

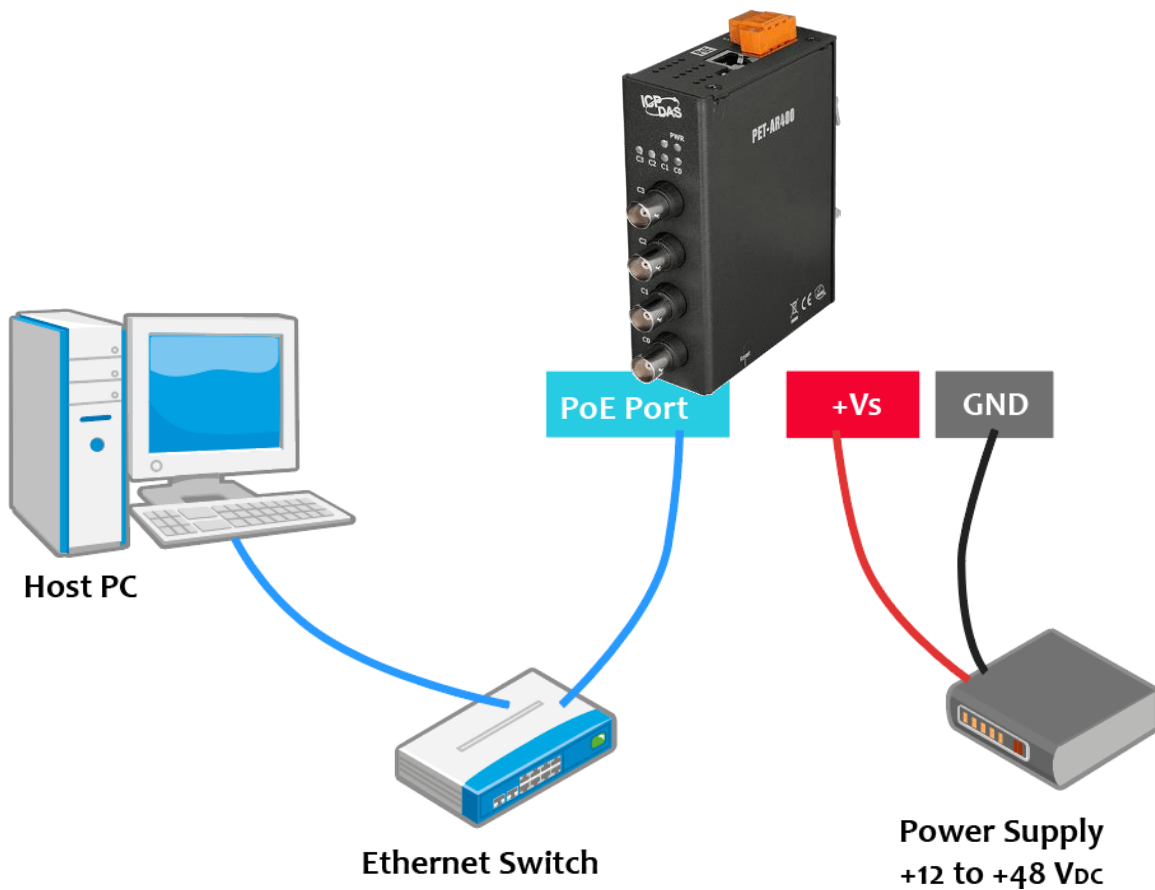

## 2.4. Installing the HSDAQ Utility





HSDAQ Utility is a user-friendly software utility. It provides functions such as updating the operating system, data acquisition and download, firmware update, and Ethernet configuration. By using this software, users can easily configure and manage the data of PET-AR400, improving operational efficiency and convenience.

For more details of HSDAQ utility, please refer to section 4.2 “HSDAQ Utility”

### Step1. Download the HSDAQ Utility

The latest version of the HSDAQ Utility can be obtained from ICP DAS download center at:

<http://www.icpdas.com/en/download/show.php?num=2327>

FILE	FILE NAME	VERSION	SIZE	DOWNLOAD
HSDAQ Utility	HSDAQ_utility_v1015.zip	1.0.1.5	3.6 M	
History (EN)	HSDAQ_utility_History.txt	1.0.1.5	3 KB	
LabVIEW	LabVIEW.zip	-	6.4 MB	
Manual Calibration	Calibrate.zip	-	17 KB	

### Step2. Follow the prompts to complete the installation

After the installation has been completed, there will be a short-cut for HSDAQ Utility on the desktop.

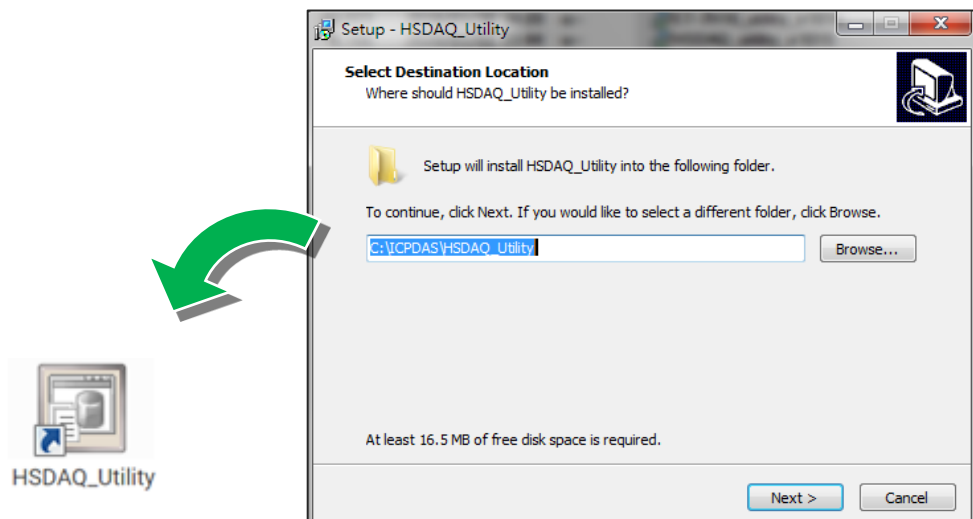

## 2.5. Assigning an IP address

PET-AR400 is an Ethernet device, which comes with a default IP address. Therefore, user must assign a new IP address.

The default IP settings are shown below.

Item	Default
IP Address	192.168.255.1
Subnet Mask	255.255.0.0
Gateway	192.168.0.1
DHCP	Disable

### Step 1. Run the HSDAQ Utility

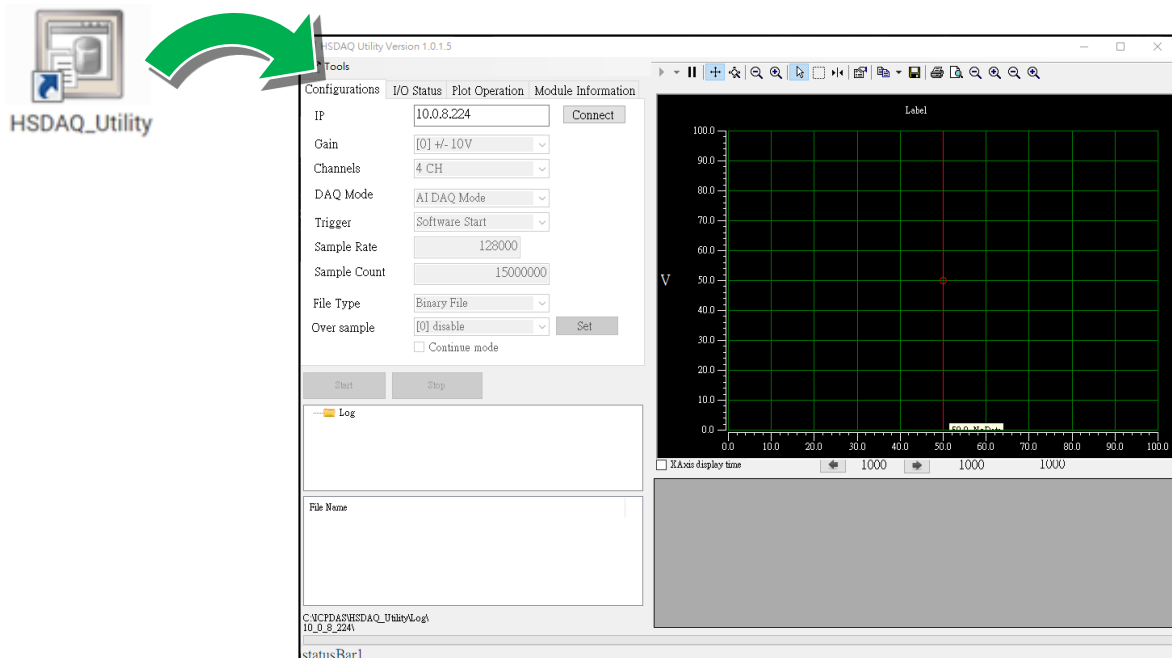



## Step 2. Choose the Search option from the Tools menu

After choosing the “Search” option, the Search dialog will appear.

## Step 3. Click the Search button to start searching the module

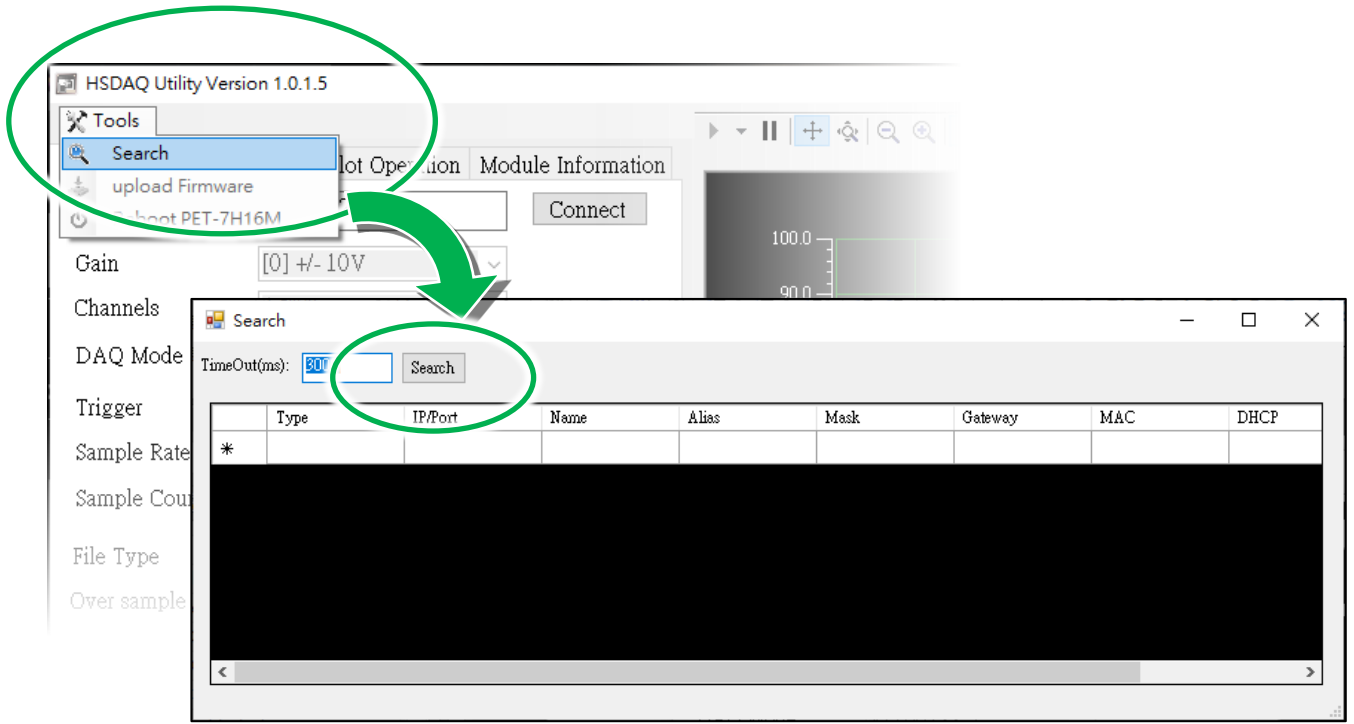

## Step 4. Click the 192.168.255.1 of the IP/Port field in the list

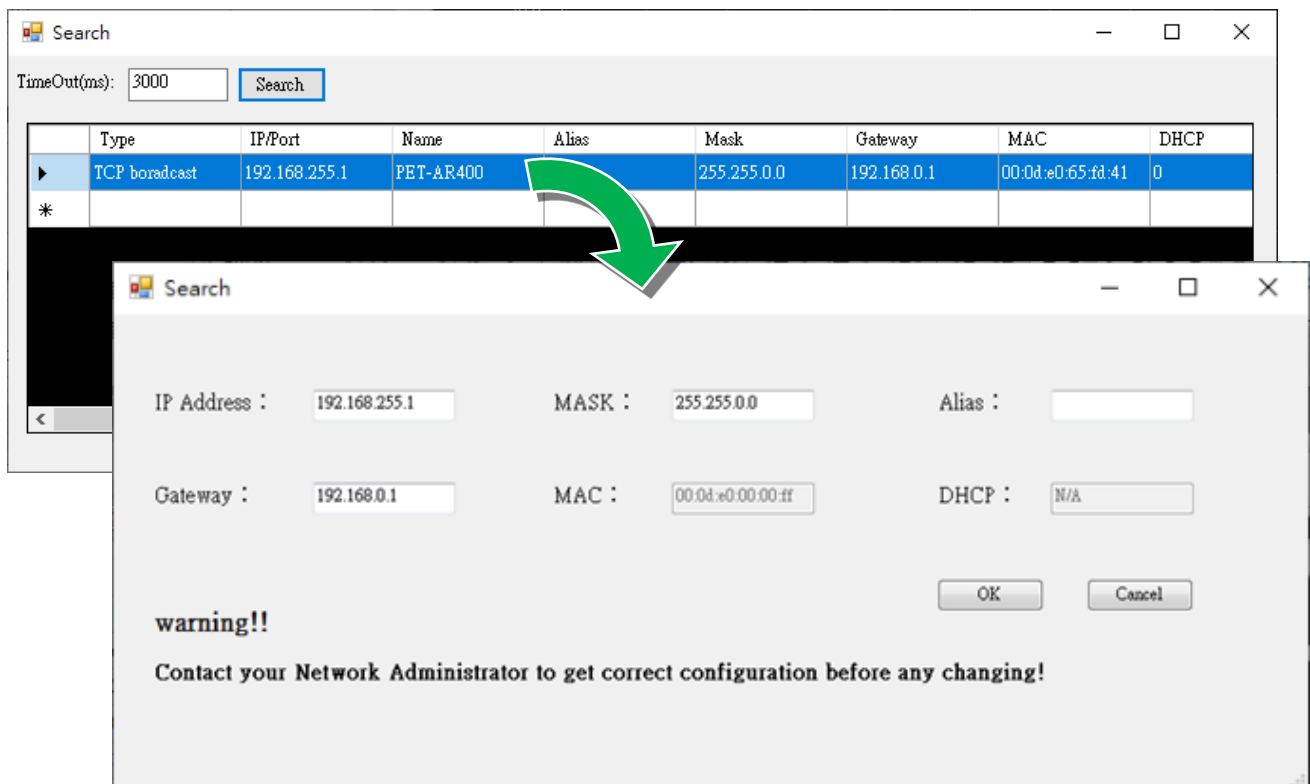

### Step 5. Assign a new IP address and then click the OK button

In the IP Settings dialog box, you can manually assign an IP Address, Mask Address, Gateway and Alias, or you can use the DHCP function to dynamically assign IP addresses.

Once the appropriate values have been entered, click the "OK" button to save the settings.

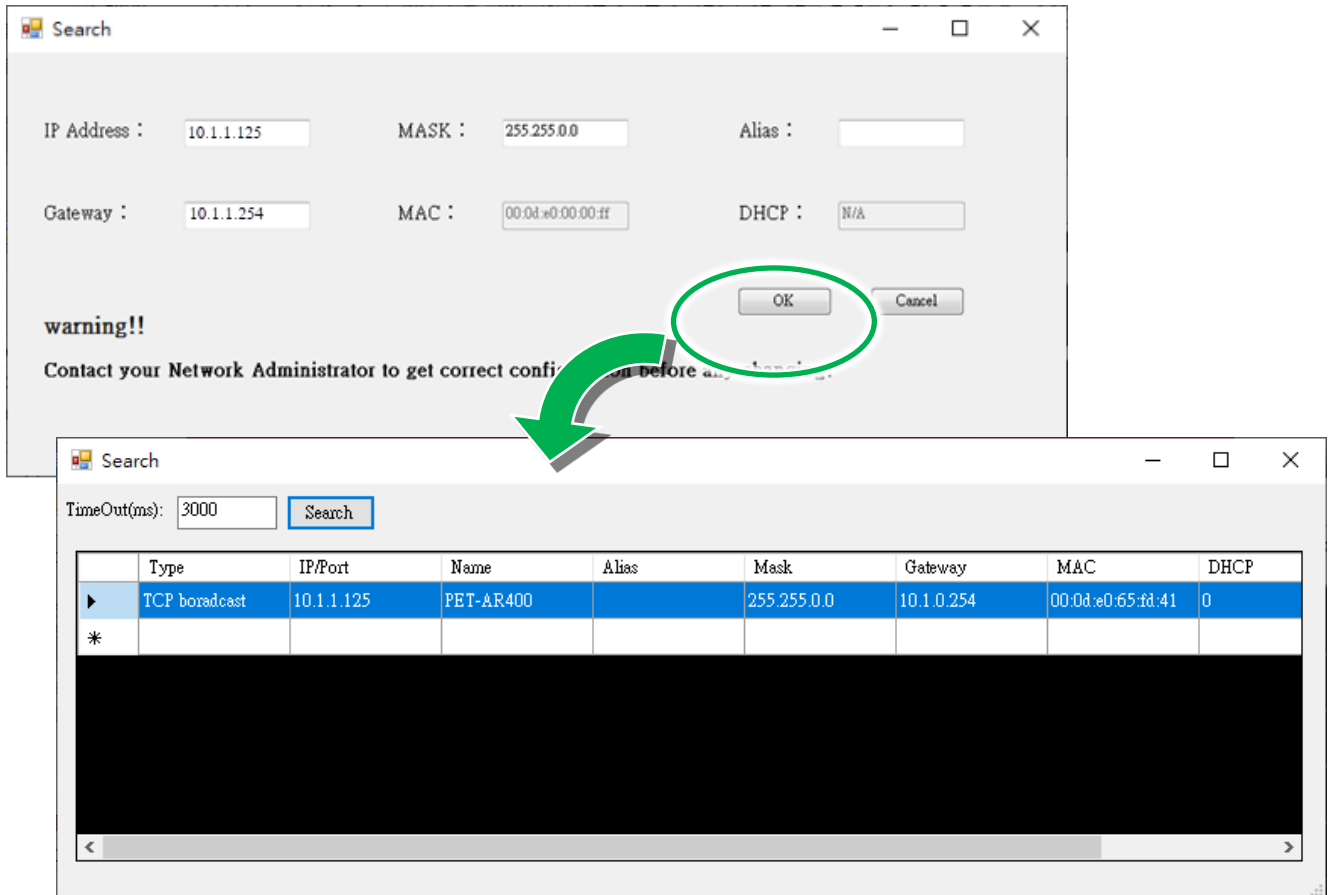

## 2.6. Acquiring and Analyzing Data

HSDAQ Utility allows users to set the data acquisition mode, control the data acquisition process, and realize the data storage and real-time display.

For more details of HSDAQ utility, please refer to section 4.2 “HSDAQ Utility”

### Step 1. Run the HSDAQ Utility

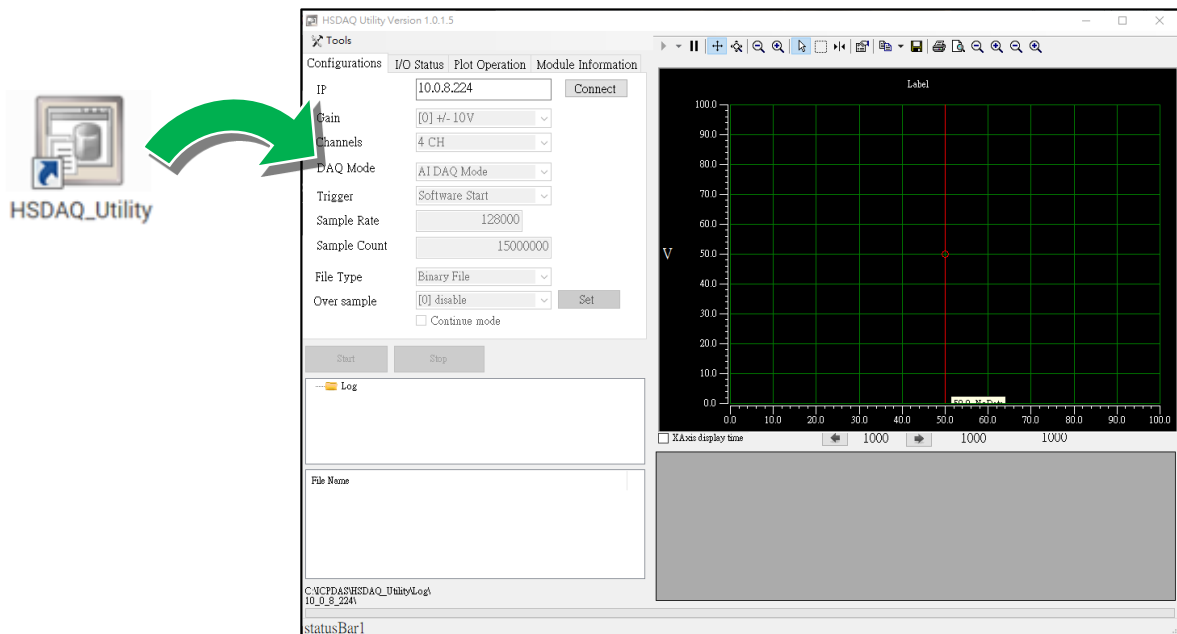

### Step 2 : Connect to PET-AR400 by using the IP address

Enter the IP address in the IP field, and then click the Connect button to connect to the PET-AR400.

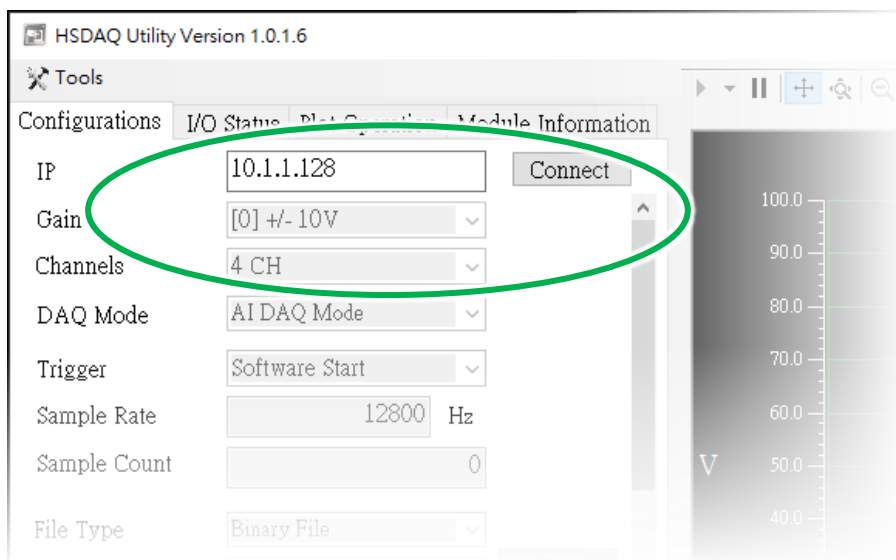

### Step 3 : Set the Data Acquisition Mode

PET-AR400 offers two data acquisition modes : one is continuous real-time acquisition mode triggered by software commands, and the other is N sample acquisition mode is activated When the analog input exceeds the specified threshold value.

#### To set the data acquisition mode to Continuous Acquisition mode

To set the data acquisition mode to continuous acquisition mode, you need to configure the following settings:

- **Channels** : Select the number of channel to be enabled.
- **Trigger** : Select **Software Start** as the trigger type.
- **Sample Rate** : Specify a value of the sample rate from 0 to 128000.
- **Sample Count** : Specify a value of the target sample from 0 to 15000000. 0 means keep collecting data until stop command is received.

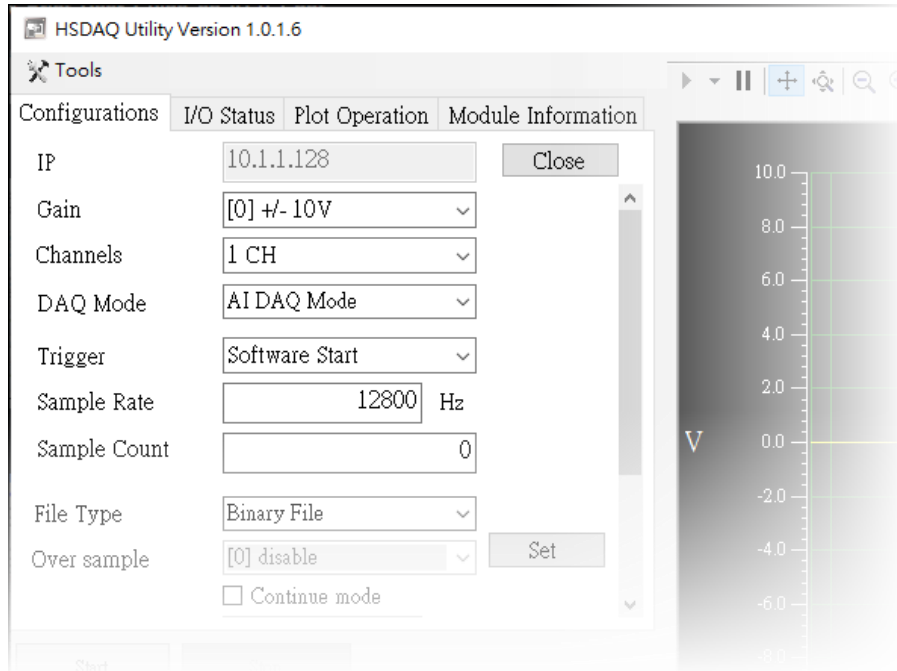

## To set the data acquisition mode to N Sample Acquisition mode

To set the data acquisition mode to N sample acquisition mode, you need to configure the following parameters:

In **Configurations** tab

- **Channels** : Select the number of channel to be enabled.
- **Trigger** : Select **Analog threshold trigger** as the trigger type.
- **Sample Rate** : Specify a value of the sample rate from 0 to 128000.
- **Sample Count** : Specify a value of the target sample from 0 to 15000000. 0 means keep collecting data until stop command is received.

In **Analog Setting** tab

- **High Level/Low Level** : Specify a value of the analog threshold trigger high/low level from +10 to -10.
- **AI Mode** : Select the analog threshold trigger conditional and specify a value of the left/right count.

The image shows two overlapping screenshots of the HSDAQ Utility software interface. The top screenshot shows the 'Configurations' tab with the 'Analog Setting' sub-tab selected, indicated by a green circle and a green arrow pointing to the bottom screenshot. The bottom screenshot shows the 'Analog Setting' tab with various configuration options. A green text box with a white background is overlaid on the interface, stating: "The Analog Setting tab will be displayed when the Analog threshold trigger is selected".

**Configurations Tab:**

- IP Address: 10.1.1.128
- Gain: [0] +/- 10V
- Channels: 1 CH
- DAQ Mode: AI DAQ Mode
- Trigger Type: Analog threshold trigger

**Analog Setting Tab:**

Channel	0	1	2	3
Enable	<input type="checkbox"/>	<input type="checkbox"/>	<input type="checkbox"/>	<input type="checkbox"/>
High Level	0.0000	0.0000	0.0000	0.0000
Low Level	0.0000	0.0000	0.0000	0.0000

Channel	4	5	6	7
Enable	<input type="checkbox"/>	<input type="checkbox"/>	<input type="checkbox"/>	<input type="checkbox"/>
High Level				
Low Level				

Left Count: 500 | AI Mode: Above | Right Count: 500

Buttons: Start, Stop, Set

#### Step 4 : Click the Start button to start collecting data

The screenshot displays the HSDAQ Utility Version 1.0.1.6 interface. The main configuration panel on the left includes fields for IP (10.1.1.128), Gain ([0] +/- 10V), Channels (1 CH), DAQ Mode, Trigger, Sample Rate, Sample Count, File Type, and Over sample. A green arrow points to the 'Start' button, which is circled in green. Below the configuration panel, a file list shows two files: '10.0.8.249' and '10.0.8.249.2017.6.9.16.20.27.bin'. The right side of the interface features a plot window titled 'ET-7H16 Data Logger Version [1001]' showing a green waveform on a grid. The plot has a vertical red line at 500.00 and a horizontal red line at 500.00. Below the plot is a data table with columns for Index, Ch0, Ch1, Ch2, Ch3, Ch4, Ch5, and Ch6. The table contains 7 rows of data, with the first row highlighted in blue.

Index	Ch0	Ch1	Ch2	Ch3	Ch4	Ch5	Ch6
0	000.000	001.330	001.331	001.331	001.331	001.331	001.331
1	000.000	001.346	001.346	001.346	001.346	001.346	001.346
2	000.000	001.360	001.361	001.361	001.361	001.362	001.361
3	000.000	001.376	001.376	001.376	001.376	001.376	001.376
4	000.000	001.390	001.391	001.391	001.391	001.391	001.391
5	000.000	001.405	001.406	001.406	001.406	001.406	001.406
6	000.000	001.420	001.421	001.421	001.421	001.421	001.421

### 3. Data Acquisition Modes

PET-AR400 offers two data acquisition modes : one is continuous real-time acquisition mode triggered by software commands, and the other is N sample acquisition mode is activated when the analog input exceeds the specified threshold value.

The table below shows the sampling frequency of each acquisition mode, including the total number of channels sampled simultaneously and the maximum sampling rate for each channel.

A/D Trigger	Data Transmission	Total simultaneous sampling channels	Maximum sampling rate
Software A/D Data Acquisition Mode	Continuous Transmission	1	12.8k/16k/32k/64k/128k Hz
		2	12.8k/16k/32k/64k Hz
		3/4	12.8k/16k/32k Hz
Analog Threshold Trigger Mode	N Sample Acquisition	1	12.8k/16k/32k/64k/128k Hz
		2	12.8k/16k/32k/64k Hz
		3/4	12.8k/16k/32k Hz

---

#### Tips & Warnings



The data in the table above were obtained through testing in a local area network, and actual users need to consider factors such as network and computer when using them.

---

### 3.1. Continuous Acquisition

The Continuous Acquisition Mode is triggered by software command.

In continuous acquisition mode with software command triggering, when the PC sends a start command to the PET-AR400, the module will begin to gather data. Once the data accumulates to a certain size, it will be sent back to the PC. The data collection process will continue until the PC sends a stop command or until the desired amount of data has been collected.

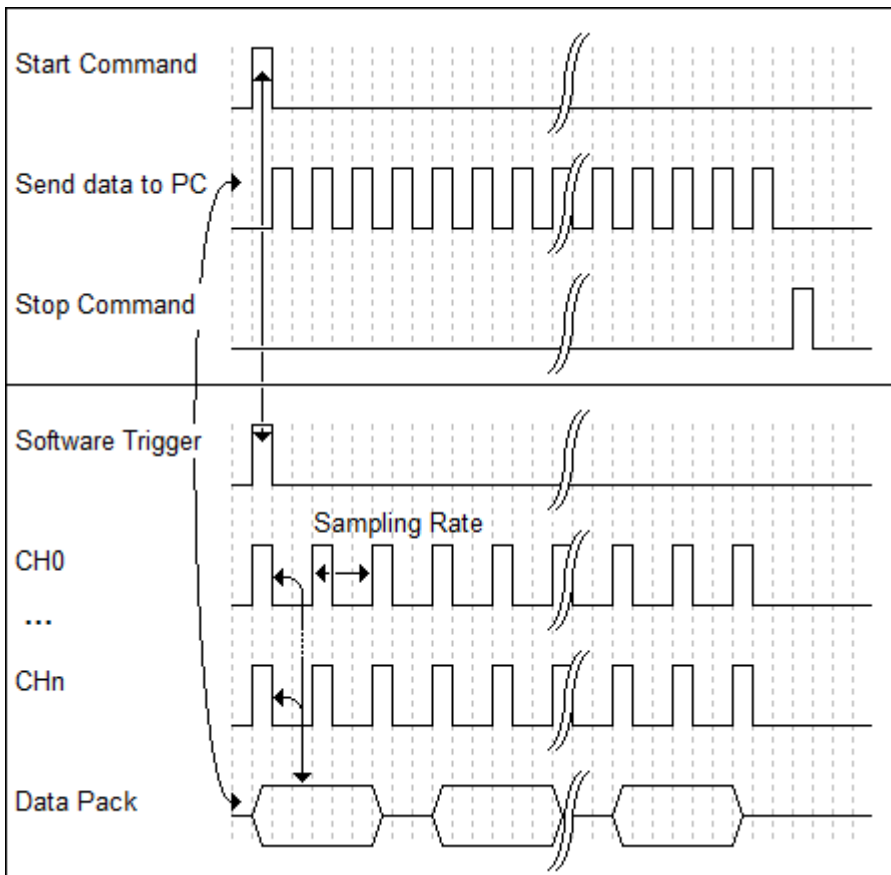

In **Continuous Acquisition** Mode, the following parameters need to be specified:

- **Channels** : Select the number of channel to be enabled.
- **Trigger** : Select **Software Start** as the trigger type.
- **Sample Rate** : Specify a value of the sample rate from 0 to 128000.
- **Sample Count** : Specify a value of the target sample from 0 to 1500000. 0 means keep collecting data until stop command is received.



## 3.2. N-Sample Acquisition

N sample acquisition mode is activated when the analog input exceeds the specified threshold value. The analog threshold trigger is activated when the input signal exceeds a set voltage value, either higher or lower. This trigger can also be utilized to detect instantaneous changes in a continuous voltage signal. The user has the flexibility to specify the desired trigger condition.

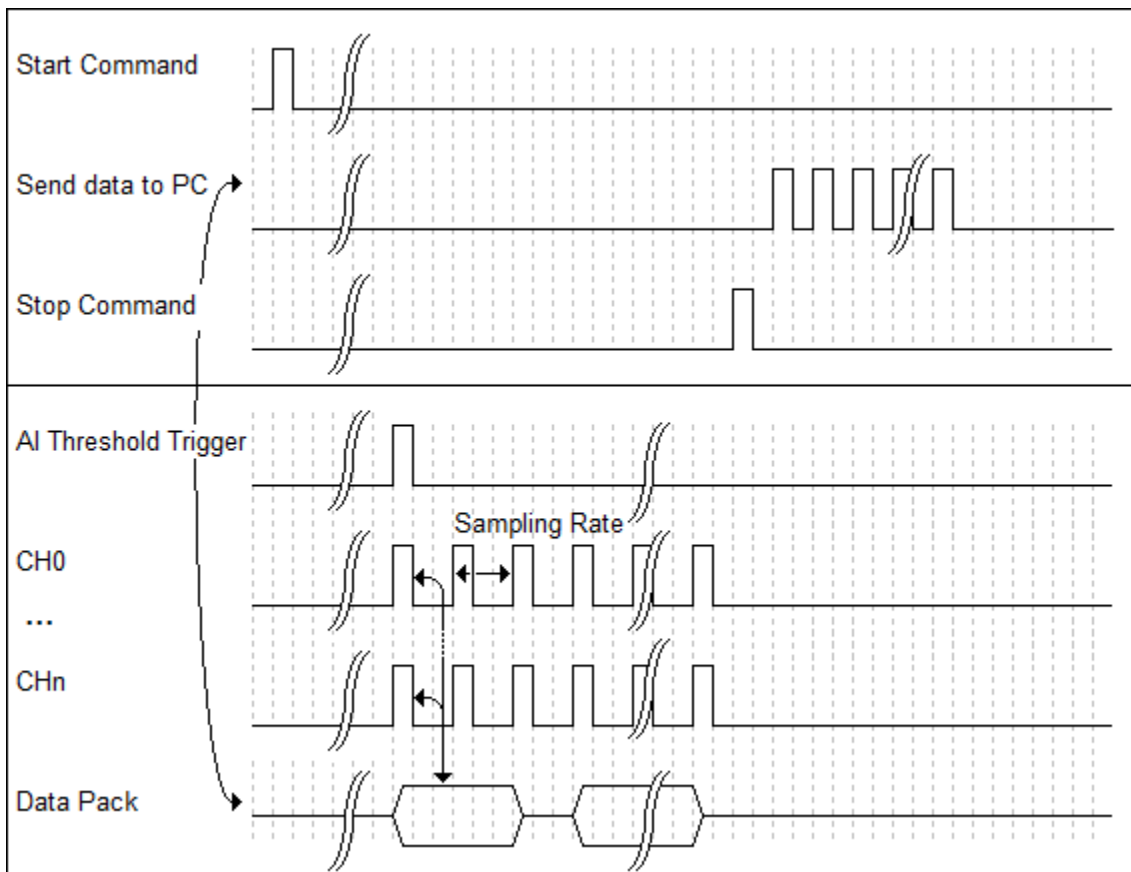

In **N-Sample Acquisition** Mode, the following parameters need to be specified:

- **Channels** : Select the number of channel to be enabled.
- **Trigger** : Select **Analog threshold trigger** as the trigger type.
- **Sample Rate** : Specify a value of the sample rate from 0 to 128000.
- **Sample Count** : Specify a value of the target sample from 0 to 15000000. 0 means keep collecting data until stop command is received.
- **High Level/Low Level** : Specify a value of the analog threshold trigger high/low level from +10 to -10.
- **AI Mode** : Select the analog threshold trigger conditional and specify a value of the left/right count.

## 4. Web Applications

PET-AR400 includes the build-in website server. Users can access it through a standard web browser.

### Tips & Warnings



Do not open the website when the module is sampling data.

### Visit PET-AR400 build-in website

The PET-AR400 website can be accessed using browsers such as Chrome, Safari, Firefox, and Internet Explorer.

### Step 1 : Open a web browser and enter the IP address

For many browsers, Mozilla Firefox and Internet Explorer are both reliable and popular Internet browsers.

### Step 2 : Enter the default user name and password

The table to the right shows the default user name and password.

Item	Default
User name	Admin
Password	Admin

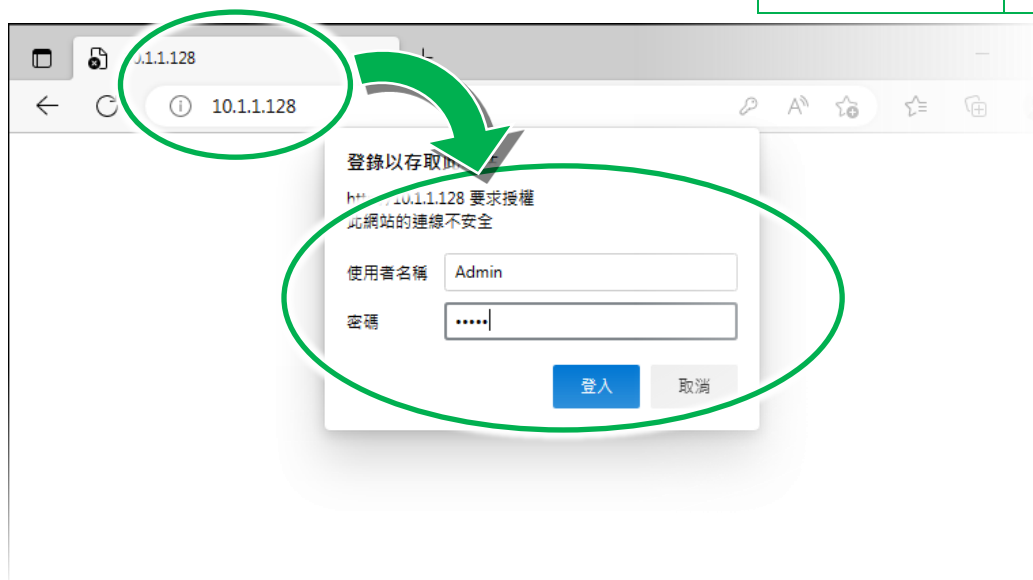

### Step 3 : Welcome to PET-AR400

After logging into the PET-AR400 web interface, the welcome page will be displayed.

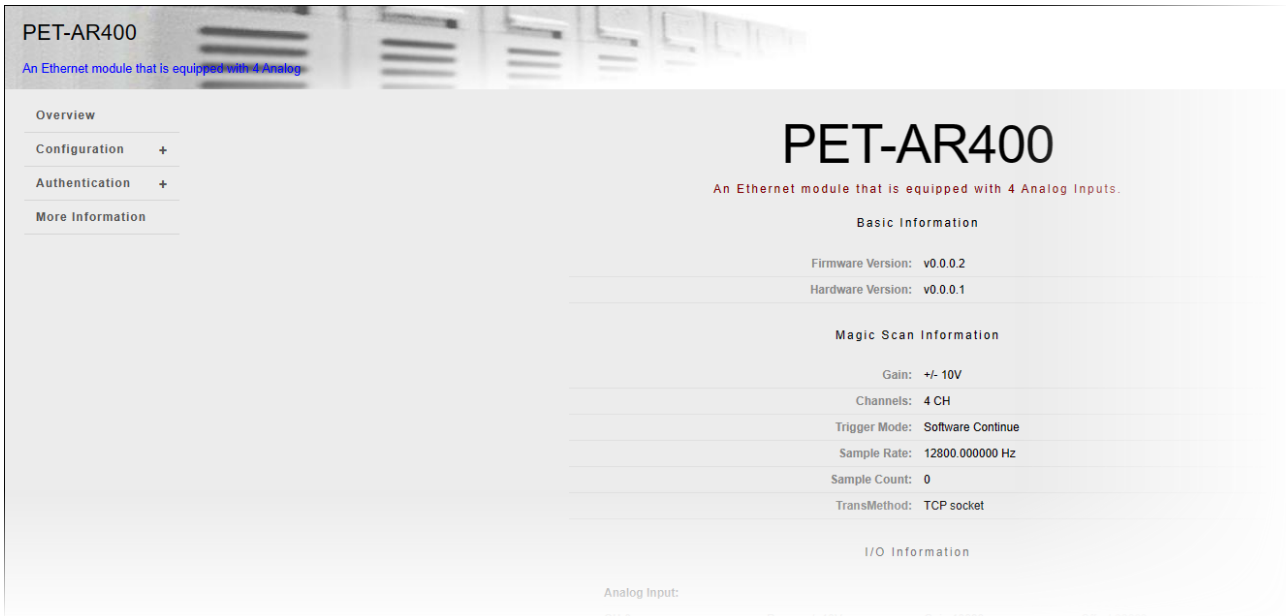

## 4.1. Overview

The overview page is the same as home page. This page shows the main system information.

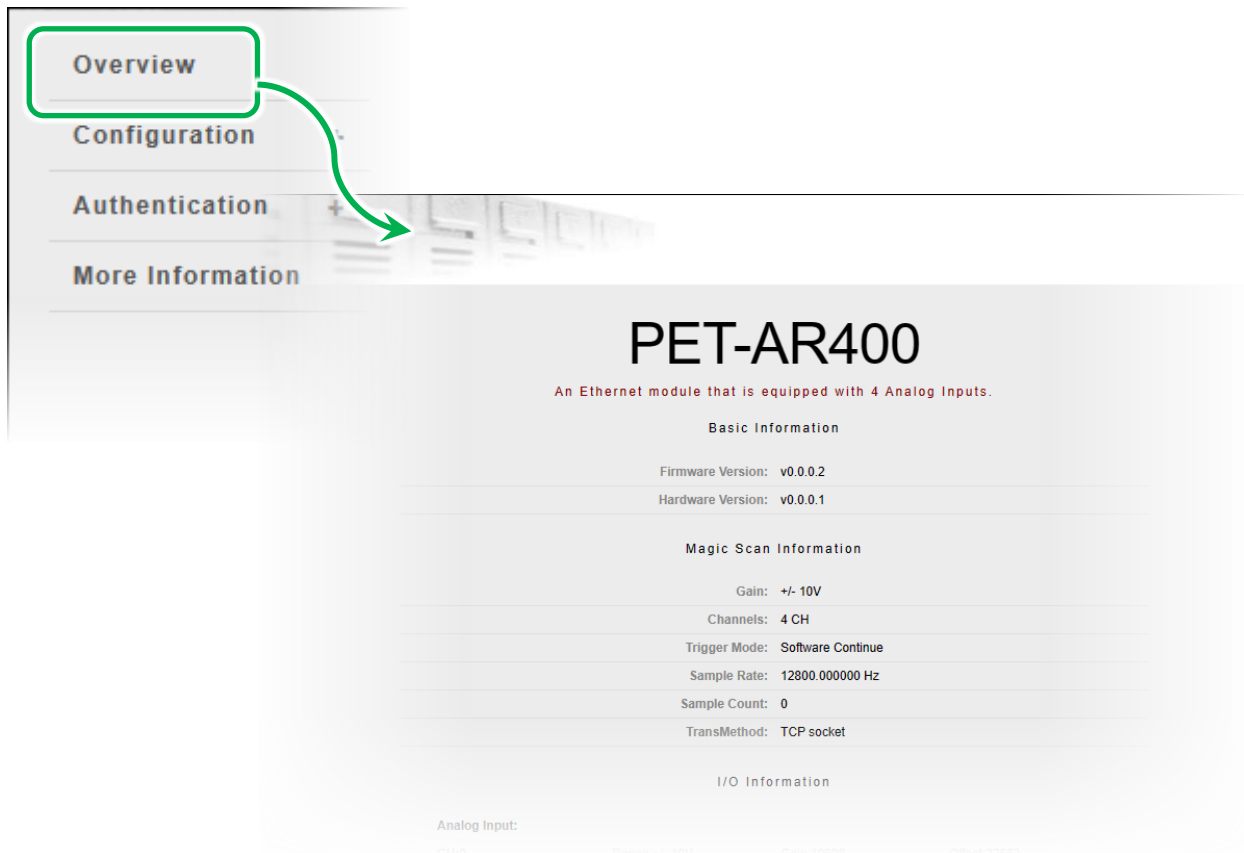

- Firmware Version
- Hardware Version
- Gain : Sampling input type
- Channels : Sampling channels
- Trigger mode : Trigger mode
- Sample Rate : Sampling rate
- Sample Count : Sampling target count
- TransMethod : Data transfer method

## 4.2. Configuration

### Network Settings

This option links to the Network Settings page that allows users to access the IP settings.

### Basic Settings

This option links to the Basic Settings page that allows users to configure the basic website information.

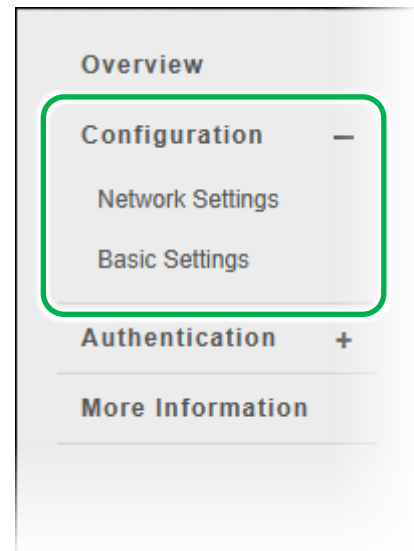

### 4.2.1. Network Settings

The Network Settings page provides an interface to set either DHCP (Roaming) or manually configured (Static) network settings. The new configuration takes effect after reset the module.

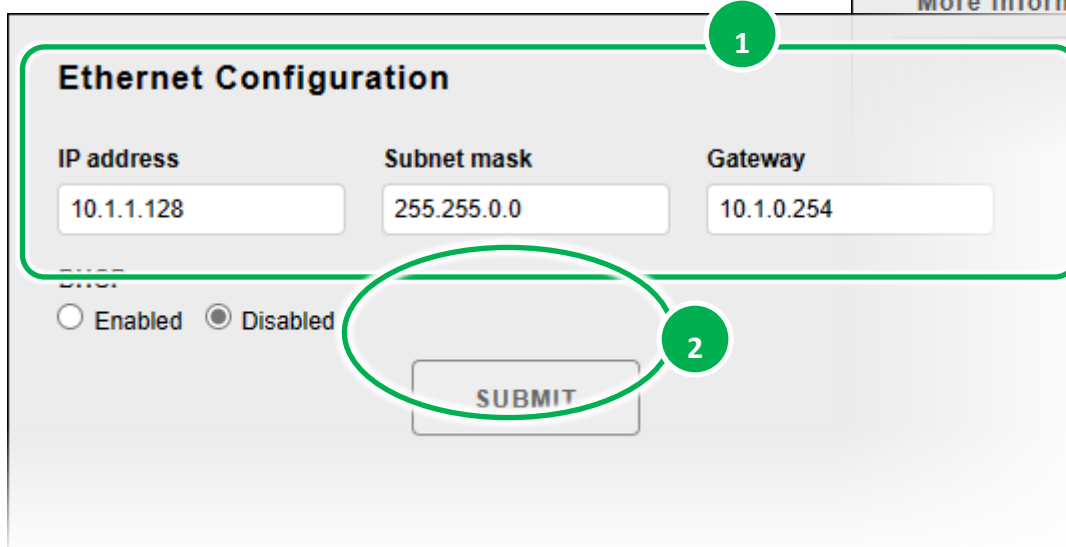
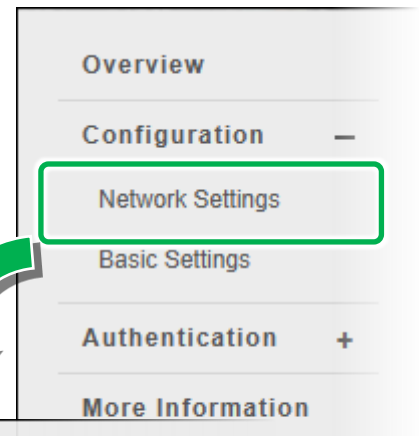

The 'Ethernet Configuration' form is shown. It has three input fields: 'IP address' with the value '10.1.1.128', 'Subnet mask' with '255.255.0.0', and 'Gateway' with '10.1.0.254'. Below these fields are radio buttons for 'Enabled' and 'Disabled', with 'Disabled' selected. A 'SUBMIT' button is at the bottom. A green box highlights the entire form area, with a '1' in a circle at the top right. A green oval highlights the 'SUBMIT' button, with a '2' in a circle at the bottom right.

## 4.2.2. Basic Settings

This page provides the following functions:

- Configure module information
- Configure server port
- Configure website message
- Restore to default

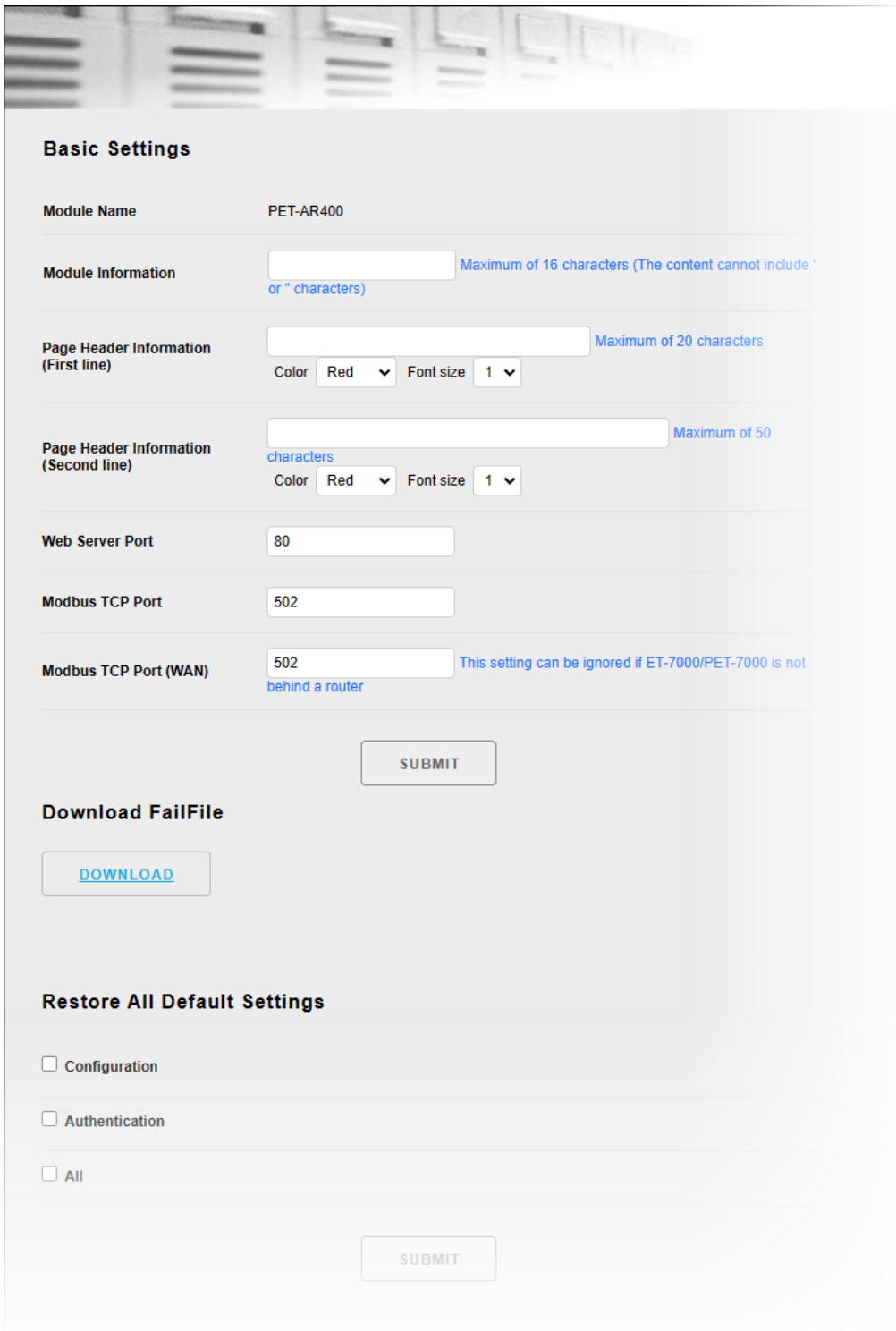

The screenshot shows a web interface for configuring the PET-AR400 module. The page is titled "Basic Settings" and contains several configuration sections:

- Module Name:** PET-AR400
- Module Information:** A text input field with a maximum length of 16 characters. A note states: "Maximum of 16 characters (The content cannot include ' or " characters)".
- Page Header Information (First line):** A text input field with a maximum length of 20 characters. Below it are dropdown menus for "Color" (set to Red) and "Font size" (set to 1).
- Page Header Information (Second line):** A text input field with a maximum length of 50 characters. Below it are dropdown menus for "Color" (set to Red) and "Font size" (set to 1).
- Web Server Port:** A text input field containing the value 80.
- Modbus TCP Port:** A text input field containing the value 502.
- Modbus TCP Port (WAN):** A text input field containing the value 502. A note states: "This setting can be ignored if ET-7000/PET-7000 is not behind a router".

Below the configuration fields, there is a "SUBMIT" button. Further down, there is a section titled "Download FailFile" with a "DOWNLOAD" button. At the bottom, there is a section titled "Restore All Default Settings" with three checkboxes: "Configuration", "Authentication", and "All". A "SUBMIT" button is located at the bottom of this section.

### 4.2.2.1. Configuring Module Information

**Module Name** : The name of the module.

**Module Information** : The alias of the module, users can modify it to identify modules.

**Basic Settings**

**Module Name** PET-AR400

**Module Information**  Maximum of 16 characters (The content cannot include ' or " characters)

**Page Header Information (First line)**  Maximum of 20 characters  
Color Red Font size 1

**Page Header Information (Second line)**  Maximum of 50 characters  
Color Red Font size 1

**Web Server Port**

**Modbus TCP Port**

**Modbus TCP Port (WAN)**  ting can be ignored if ET-7000/PET-7000 is not behind a router

**SUBMIT**

**Download FailFile**

[DOWNLOAD](#)

[Restore All Default Settings](#)

## 4.2.2.2. Configuring build-in website information

**Page title (First line)** : The modifiable title of the web server.

**Page subtitle (Second line)** : The modifiable subtitle of the web server.

**PET-AR400** Page Header Information (First line)  
An Ethernet module that is equipped with 4 Analog Page Header Information (Second line)

Overview  
Configuration

Basic Settings

Module Name PET-AR400

Module Information

Page Header Information (First line) PET-AR400 Maximum of 20 characters  
Color Black Font size 1

Page Header Information (Second line) An Ethernet module that is equipped with 4 Analog Maximum of 50 characters  
Color Green Font size 1

Web Server Port 80

Modbus TCP Port 502

Modbus TCP Port (WAN) 502 This setting can be ignored if ET-7000/PET-7000 is not behind a router

SUBMIT

Download FailFile

DOWNLOAD



### 4.2.2.3. Configuring the Command port and data transmit port

Users can modify the port to fit the network environment.

- **Web server port** : Default is 80
- **Modbus TCP port** : Default is 502
- **Command port** : Default is 9999
- **Data transmit port** : Default is 10010

**Basic Settings**

Module Name: PET-AR400

Module Information:  Maximum of 16 characters (The content cannot include ' or " characters)

Page Header Information (First line):  Maximum of 20 characters  
Color: Black Font size: 1

Page Header Information (Second line):  Maximum of 50 characters  
Color: Green Font size: 1

Web Server Port:

Modbus TCP Port:

Modbus TCP Port (WAN):  This can be ignored if ET-7000/PET-7000 is not behind a router.

**Download FailFile**

If the Ethernet ports are restricted by the firewall, users can change them to different ports so the firewall doesn't block them.

If the command or data transmit port changes, please refer to the "HS\_Device\_Create()" of the API manual to learn how to connect by the SDK.

<https://www.icpdas.com/en/download/show.php?num=2599>

#### 4.2.2.4. Restoring to default

Users can choose the following types of setting to be restored.

- **Configuration**
- **Authentication**
- **All**

The screenshot shows a web interface titled "Restore All Default Settings". It contains three checkboxes: "Configuration", "Authentication", and "All". A green box labeled "1" encloses these checkboxes. Below them is a "SUBMIT" button, which is highlighted by a green oval labeled "2".

#### Default Settings for Configuration

---

##### Network Settings

Item	Factory Default Settings
IP	192.168.255.1
Gateway	192.168.0.1
Mask	255.255.0.0
DHCP	Disable

##### Basic Settings

Item	Factory Default Setting
Module Name	PET-AR400
Module Information	Empty
Top page Information (First line)	ICP DAS
Top page Information (Second line)	<a href="http://www.icpdas.com">http://www.icpdas.com</a>
More Information URL	<a href="https://www.icpdas.com/en/product/PET-AR400">https://www.icpdas.com/en/product/PET-AR400</a>
Web Server TCP Port	80

## Default Settings for Authentication

---

### Account Management

Item	Factory Default Setting
User name	Admin
Password	Admin

### Accessible IP Settings

Item	Factory Default Setting
IP filter	None, no device is filtered.

## 4.3. Authentication

### Account Management

This option links to the Privilege management page that allows users to manage the user accounts and their privileges

### Accessible IP Settings

This option links to the IP filter Settings page that allow users to control access to the website.

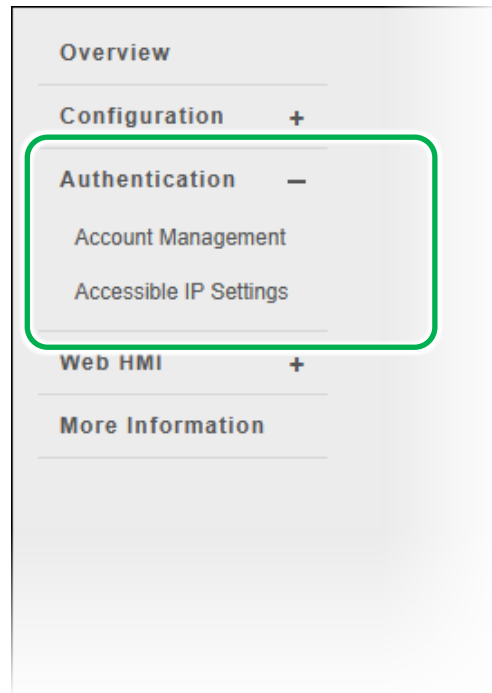

### 4.3.1. Accounts Management

Account Management provides the following functions:

- **Configure the user accounts**
- **Restore to the default settings.**

**Privilege Management**

No.	Account	Password	Verify Password	Authority	Enabled
1	Admin	****	****	Admin ▾	<input checked="" type="checkbox"/>
2	<input type="text" value="ICPDAS"/>	*****	*****	User ▾	<input type="checkbox"/>
3	<input type="text"/>	<input type="text"/>	<input type="text"/>	Admin ▾	<input type="checkbox"/>
4	<input type="text"/>	<input type="text"/>	<input type="text"/>	Admin ▾	<input type="checkbox"/>
5	<input type="text"/>	<input type="text"/>	<input type="text"/>	Admin ▾	<input type="checkbox"/>

**Reset Settings**

Restore settings to the defaults

### 4.3.1.1. Configuring the user accounts

Account management supports max five accounts, including an administrator account and four user-defined accounts.

The administrator account cannot be deleted or modified; only the password can be changed.

- **Account** : Define a specified name as the account.
- **Password** : Needs to type is twice to ensure it is correct.
- **Authority** : Set user authority, different levels allow different operations.
  - Admin** : Allows access to all website functions, including reading information and changing various settings.
  - User** : Allows access to the part of website functions, cannot change any settings.
- **Enable** : Enable or disable account.

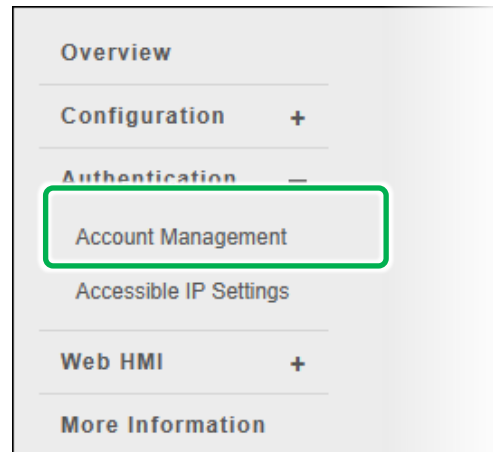
A screenshot of the 'Privilege Management' form. It features a table with columns: No., Account, Password, Verify Password, Authority, and Enabled. A green circle with the number '1' is placed above the table. Below the table, a 'SUBMIT' button is circled in green with a green circle containing the number '2'. A green arrow points from the 'Account Management' menu item in the previous image to the 'Privilege Management' form.

No.	Account	Password	Verify Password	Authority	Enabled
1	Admin	....	....	Admin ▾	<input checked="" type="checkbox"/>
2	ICPDAS	.....	.....	User ▾	<input type="checkbox"/>
3				Admin ▾	<input type="checkbox"/>
4				Admin ▾	<input type="checkbox"/>
5				Admin ▾	<input type="checkbox"/>

### 4.3.1.2. Restoring to default setting

Click "RESET SETTINGS" will be fine.

The screenshot shows a web interface for Privilege Management. At the top right, a navigation menu includes 'Overview', 'Configuration +', 'Authentication -', 'Account Management' (highlighted with a green box), and 'Accessible IP Settings'. A green arrow points from this menu to the main content area. The main content area has a header 'Privilege Management' and a table with the following columns: 'No.', 'Account', 'Password', 'Verify Password', 'Authority', and 'Enabled'. The table contains five rows. Row 1 has 'Admin' as the account name, a checked 'Enabled' checkbox, and 'Admin' authority. Row 2 has 'ICPDAS' as the account name, an unchecked 'Enabled' checkbox, and 'User' authority. Rows 3, 4, and 5 have empty account names, unchecked 'Enabled' checkboxes, and 'Admin' authority. Below the table is a 'SUBMIT' button. At the bottom left, there is a 'Reset Settings' section with a 'RESET SETTINGS' button circled in green.

No.	Account	Password	Verify Password	Authority	Enabled
1	Admin	....	....	Admin ▾	<input checked="" type="checkbox"/>
2	ICPDAS	.....	.....	User ▾	<input type="checkbox"/>
3				Admin ▾	<input type="checkbox"/>
4				Admin ▾	<input type="checkbox"/>
5				Admin ▾	<input type="checkbox"/>

**Reset Settings**  
Reset settings to the default.

RESET SETTINGS

### 4.3.2. IP Filter

IP Filter is used to allow specific IP address access the web server.

**IP Filter Settings**

IP address of the local computer is 10.1.0.28

Enable the IP filter table

No.	Activate	From (IP Address)	To (IP Address)
1	<input type="checkbox"/>	<input type="text"/>	<input type="text"/>
2	<input type="checkbox"/>	<input type="text"/>	<input type="text"/>
3	<input type="checkbox"/>	<input type="text"/>	<input type="text"/>
4	<input type="checkbox"/>	<input type="text"/>	<input type="text"/>
5	<input type="checkbox"/>	<input type="text"/>	<input type="text"/>
6	<input type="checkbox"/>	<input type="text"/>	<input type="text"/>

#### Tips & Warnings



By default, no device is filtered.

## Configure IP Filter

This filter will depend on the filter list allow the device to visit the website.

There are two ways to configure the filter list.

### Method1 : Allow single device to visit

1. Enable the IP filter table
2. Type an IP address
3. Enable "Activate"
4. Click "SUBMIT"
5. The settings take effects after reboot

The screenshot shows the 'IP Filter Settings' configuration page. At the top, it displays 'IP address of the local computer is 10.1.0.18'. Below this, there is a checkbox labeled 'Enable the IP filter table' which is checked. A table with four columns: 'No.', 'Activate', 'From (IP Address)', and 'To (IP Address)' is shown. The first row of the table has the 'Activate' checkbox checked and both 'From' and 'To' IP address fields containing '10.0.8.12'. Below the table is a 'SUBMIT' button.

No.	Activate	From (IP Address)	To (IP Address)
1	<input checked="" type="checkbox"/>	10.0.8.12	10.0.8.12
2	<input type="checkbox"/>		
3	<input type="checkbox"/>		
4	<input type="checkbox"/>		
5	<input type="checkbox"/>		
6	<input type="checkbox"/>		



## Method 2 : Allow a group of device to visit

1. Enable the IP filter table
2. Input a segment of IP in From (IP Address) and To (IP Address)
3. Enable “Activate”
4. Click “SUBMIT”
5. The settings take effects after reboot

The screenshot shows the 'IP Filter Settings' configuration page. At the top, it displays the local computer's IP address as 10.1.0.18. Below this, there is a checkbox labeled 'Enable the IP filter table' which is checked. A table with six rows follows, each with columns for 'No.', 'Activate', 'From (IP Address)', and 'To (IP Address)'. The first row is filled with the values 1, checked, 10.0.8.12, and 10.0.8.17. The remaining rows are empty. At the bottom of the form is a 'SUBMIT' button.

No.	Activate	From (IP Address)	To (IP Address)
1	<input checked="" type="checkbox"/>	10.0.8.12	10.0.8.17
2	<input type="checkbox"/>		
3	<input type="checkbox"/>		
4	<input type="checkbox"/>		
5	<input type="checkbox"/>		
6	<input type="checkbox"/>		

## 4.4. More Information

After click the “More Information” option, it will link to the ICP DAS website and show the PAT-AR400 main page, which provides more detailed information.

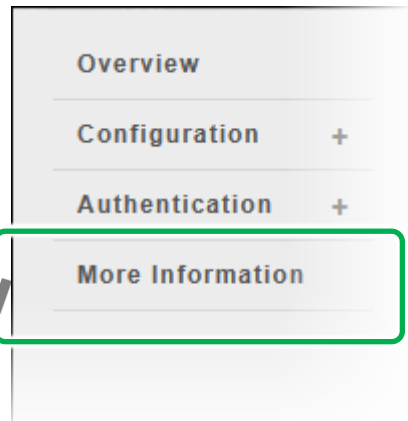

The screenshot shows the ICP DAS website interface. At the top, there is a search bar with 'Keyword' and 'Tag' fields, and a language dropdown set to 'English'. The navigation menu includes 'PRODUCTS', 'SOLUTIONS', 'NEWS & EVENTS', 'SUPPORT', 'CORPORATE', and 'CONTACT US'. The breadcrumb trail reads: 'HOME > PRODUCTS > Remote I/O Module and Unit > Ethernet I/O Modules > PET-7H18M/PET-7H24M > PET-AR400'. The main heading is 'PET-AR400' with a status 'Available soon'. Below this, it says 'PoE Ethernet High Speed Data Acquisition Module, 4-ch Accelerometer (IEPE) Inputs' and provides a 'Data Sheet' link. A large image of the black PAT-AR400 module is shown on the left. To its right, the 'Features' section lists:

- 4 differential IEPE input • Excitation Current 4 mA
- 24-bit ADC with Built-in Sinc3 Filter
- Supports Real Sample and Hold
- Sample Rate up to 128 kS/s(One Channel)
- Continuous and N Data Sample Data Transmission Mode
- A/D Trigger Mode
  1. Software Trigger
  2. Analog Threshold Trigger
- Software Support
  1. Supported Operating Systems
    - Windows 7/8/10 and Linux
  2. Software Compatibility
    - a. Microsoft VC, C#, VB.NET SDK API and Demo
    - b. NI LabVIEW Toolkit and Demo for Windows
    - c. C/C++ library and Demo for Linux
- Built-In 10/100BASE-T Auto-negotiating, Auto MDI/MDI-X Ethernet Port
- Option for External Power Supply or POE Supply

At the bottom right of the page, there is a 'TOP' button.

## 5. Modbus Application

Modbus is a communication protocol that was developed by Modicon Inc. in 1979, and was originally designed for use with Modicon controllers. Detailed information regarding the Modbus protocol can be found at: <http://www.modbus.org>.

The different versions of the Modbus protocol used today include Modbus RTU, which is based on serial communication interfaces such as RS-485 and RS-232, Modbus ASCII and Modbus TCP, which uses the Modbus RTU protocol embedded into TCP packets.

Modbus TCP is an internet protocol. The protocol embeds a Modbus frame into a TCP frame so that a connection oriented approach is obtained, thereby making it more reliable. The master queries the slave and the slave responds with a reply. The protocol is open and, hence, highly scalable.

### Modbus Message Structure

Modbus devices communicate using a master-slave (client-server) technique in which only one device (the master/client) can initiate transactions (called queries). The other devices (slaves/servers) respond by either supplying the requested data to the master, or by taking the action requested in the query.

A query from a master will consist of a slave address (or broadcast address), a function code defining the requested action, any required data, and an error checking field. A response from a slave consists of fields confirming the action taken, any data to be returned, and an error checking field.

## 5.1. Modbus/TCP Interface

Modbus TCP/IP uses port 502 to listen and receive Modbus messages over Ethernet.

## 5.2. Modbus/TCP Data Frame

The complete Modbus/TCP ADU (Application Data Unit) is embedded into the data field of a standard TCP frame and sent via TCP on port 502. The Modbus/TCP ADU is shown below.

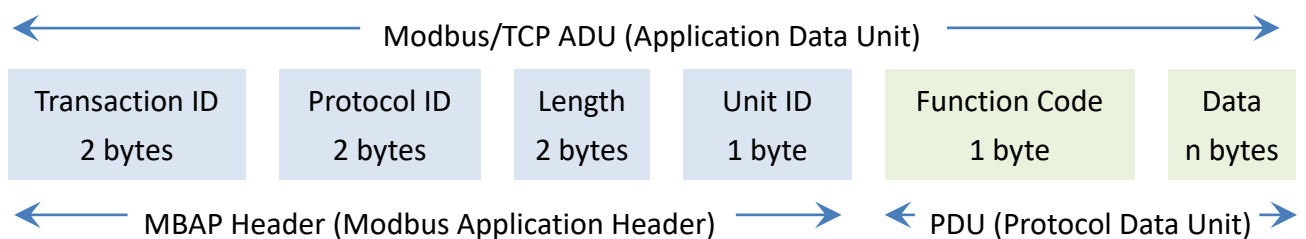

### MBAP Header

The MBAP is a 7-byte header that contains the following information:

Transaction ID	Protocol ID	Length	Unit ID
2 bytes	2 bytes	2 bytes	1 byte
byte 0 ~ 1	byte 2 ~ 3	byte 4 ~ 5	byte 6

**Transaction ID** : 2 bytes are set by the Master to uniquely identify each request.

**Protocol ID** : 2 bytes are set by the Master, will always be 00 00, which corresponds to the Modbus protocol.

**Length** : 2 bytes are set by the Master, identifying the number of bytes in the message that follow. It is counted from Unit Identifier to the end of the message.

**Unit ID** : 1 byte is set to Master. It is repeated by the Slave device to uniquely identify the Slave device. Available unit identifier is in the range of 0 to 247. Unit identifier 0 is used for general broadcast, while unit identifier 1 to 247 is given to individual Modbus devices.

## PDU

Function Code	Data
1 byte	N bytes
byte 7	byte 8 ~ n

### Function Code

The function code field of a Modbus data unit is coded in one byte. Valid codes are in the range of 1 ... 255 decimal (the range 128 - 255 is reserved and used for exception responses). When a Modbus request is sent from a Modbus Client to a Server device the function code field tells the Server what kind of action to perform.

The table below shows the mapping between the function code and the register number for the PET-AR400.

Function Code				Register Number	
Number	Function	Object	I/O Type	Number	Size
01 (0x01)	Read	Coils	Digital Output	0xxxxx	1-bit
03 (0x03)	Read	Multiple Holding Registers	Analog Output	4xxxx	16-bit
04 (0x04)	Read	Input Registers	Analog Input	3xxxx	16-bit
05 (0x05)	Write	Single Coil	Digital Output	0xxxx	1-bit
06 (0x06)	Write	Single Holding Register	Analog Output	4xxxx	16-bit
15 (0x0F)	Write	Multiple Coil	Digital Output	0xxxx	1-bit
16 (0x10)	Write	Multiple Holding Registers	Analog Output	4xxxx	16-bit

### Data

Data is transmitted in 8-bit, 16-bit and 32-bit format.

The data for 16-bit registers is transmitted in high-byte first format.

For example: 0x0A0B ==> 0x0A, 0x0B.

The data for 32-bit registers is transmitted as two 16-bit registers, and is low-word first.

For example: 0x0A0B0C0D ==> 0x0C, 0x0D, 0x0A, 0x0B.

The data field may be nonexistent (of zero length) in certain kinds of requests; in this case the server does not require any additional information. The function code alone specifies the action.

## 5.3. Modbus Register Map

The tables below are intended to be used as a reference for users who need to communicate with the PET-AR400 over a Modbus network.

### Coil Register (0xxxx) address table

Register	Points	Description	Parameter	Data Type	R/W	Default
34	1	IEPE input data high/low WORD arrangement	0 : Big endian 1 : Little endian	1	R/W	0
36	1	Clear reboot count	1 : Reset	1	W	-
40	1	Set the AI Data format	0 : 2's comp HEX 1 : Engineering Format	1	R/W	-
112	1	Reboot the module	1 : Reboot	1	W	-

### Tips & Warnings



The PET-AR400 is bi-endian in that it supports byte ordering in both little endian and big endian. The byte ordering can be defined by the value in register 00034. For example, consider a 32-bit data with a hexadecimal notation of 0x12345678. The number is 4 bytes wide.

In **Big Endian**, this number is represented as:

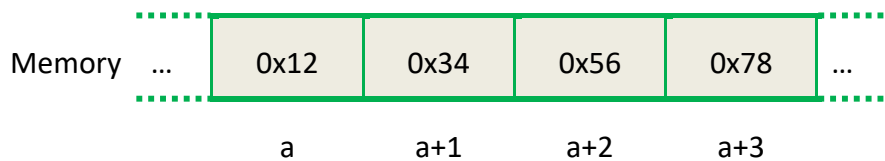

In **Little Endian**, the same number is represented as:

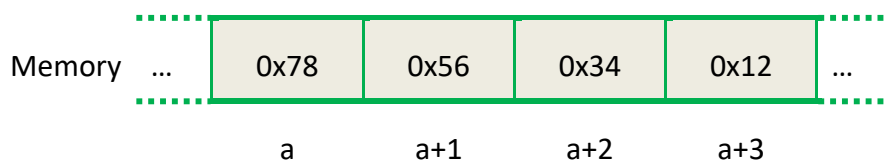

### Input Register (3xxxx) address table

Register	Points	Description	Parameter	Data Type	R/W	Default
0	4	IEPE input	2' comp HEX: -10 ~ + 10 V =-2147483648 ~ 2147483647 Engineer Format: -10 ~ + 10 V = -10000000 ~ +10000000	DWORD	R	-
80	1	Number of the DI channel	0	Word	R	-
81	1	Number of the DO channel	0	Word	R	-
82	1	Number of the AI channel	4	Word	R	-
83	1	Number of the AO channel	0	Word	R	-
84	1	Number of the Encoder channel	0	Word	R	-
90	1	OS image version	0 ~ 65535	Word	R	-
91	1	Firmware version	0 ~ 65535	Word	R	-
92	1	ET7H24 Library version	0 ~ 65535	Word	R	-
94	1	TCP library version	0 ~ 65535	Word	R	-
95	1	Web server library version	0 ~ 65535	Word	R	-
100	1	Read module name	0 x A400	Word	R	-

### Holding Register (4xxxx) address table

Register	Points	Description	Parameter	Data Type	R/W	Default
50	1	Read the boot count	1 ~ 65535	Word	R/W	-
51	1	Read module reboot status	1 : Power-on 2 : Watchdog 3 : Software reboot	Word	R	-
60	1	Modbus ID, always 1	0 ~ 255	Word	R	-

## 6. Software and Tools

PET-AR400 supports a number of external tools to help users develop applications.

### 6.1. LabVIEW

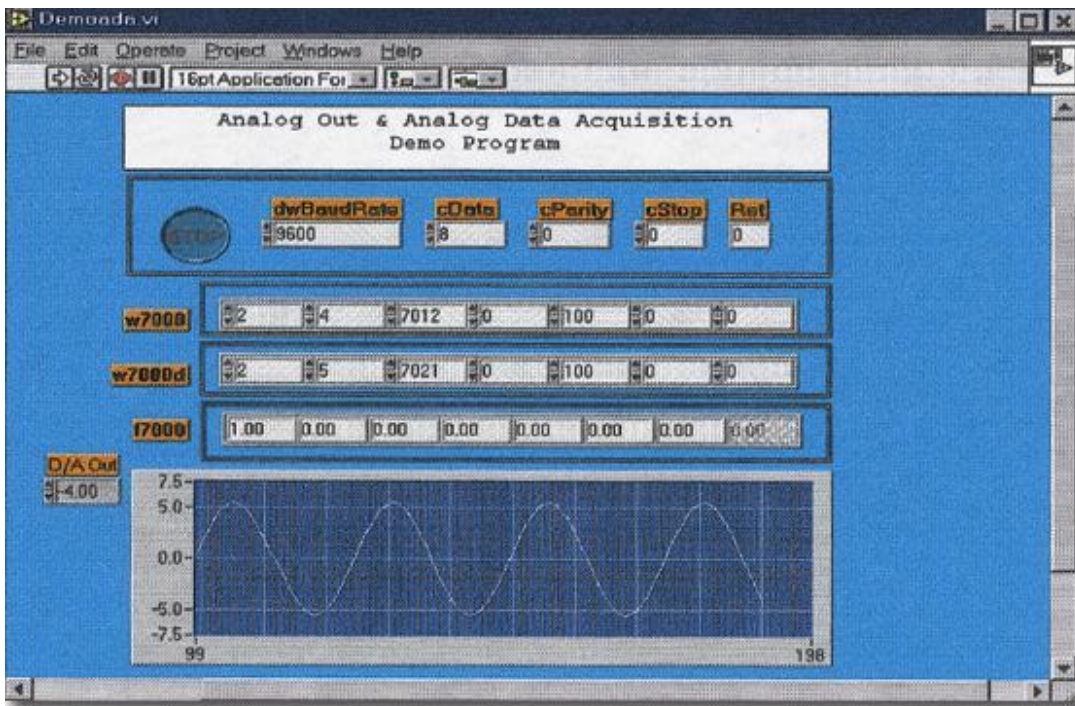

LabVIEW is the best way to acquire, analyze, and present data. LabVIEW delivers a graphical development environment that can be used to quickly build data acquisition quickly, instrumentation and control systems, boosting productivity and saving development time. With LabVIEW, it is possible to quickly create user interfaces that enable interactive control of software systems. To specify your system functionality, simply assemble block diagram – a natural design notation for scientists and engineers

The document containing the detailed instructions for linking to the PET-AR400 using Modbus protocol is located on the shipped :

[http://www.icpdas.com/web/product/download/io\\_and\\_unit/ethernet/pet-7h16m/software/utility/LabVIEW.zip](http://www.icpdas.com/web/product/download/io_and_unit/ethernet/pet-7h16m/software/utility/LabVIEW.zip)



## 6.2. HSDAQ Utility

HSDAQ Utility is used to graphically display and easily data logging for PET-AR400.

When connect to the module, it will get the gain and offset values of calibration and the configurations of sampling.

Once sampling has started, it will start collecting data from the module and saving the data to a file. Select the log file and the data will be show on the plot view.

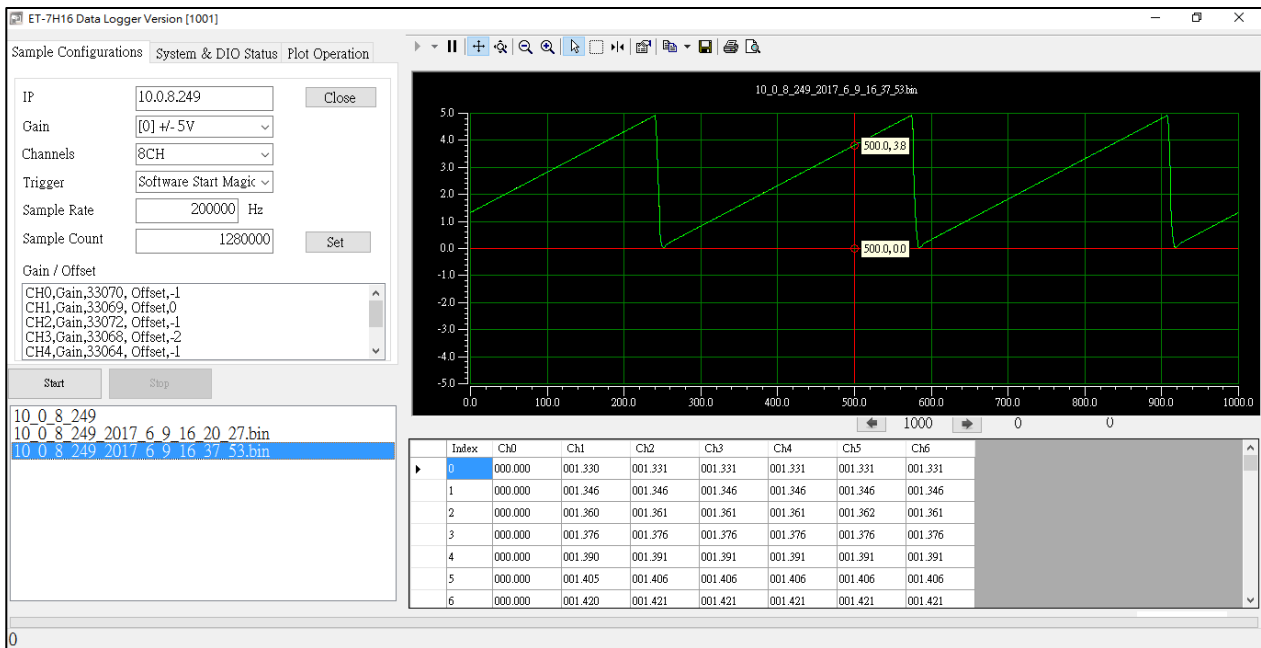

### System requirement

Minimum system requirements for HSDAQ Utility are as following:

- 266MHz 32-bit(x86) or 64-bit(x64) processor
- 64 MB of system memory
- Support for Super VGA graphics
- At least 20 MB of available space (Need more)
- Microsoft Windows 7 or later (32-bit or 64-bit Windows Operating System)

### Operating system of Windows requirement

- 32-bit(x86) 64-bit(x64)
- Microsoft Windows 7 32-bit Microsoft Windows 7 64-bit
- Microsoft Windows 8 32-bit Microsoft Windows 8 64-bit
- Microsoft Windows 10 32-bit Microsoft Windows 10 64-bit

## 6.3. PET-AR400 SDKs

HSDAQ SDKs comprises a set of API functions that you can use to access and develop PET-AR400. With the HSDAQ SDKs you can customize the standard features and integrating with other applications, devices and services for PET-AR400. Therefore, before programming with PET-AR400, the HSDAQ SDKs should already be installed on your system.

The latest version of the HSDAQ SDKs can be obtained from:

<http://www.icpdas.com/en/download/show.php?num=2326>

### Development Environment Preparation

#### HSDAQ SDK Installation Package for Operating System

The HSDAQ SDK Installation packages are divided according to the supported operating system. The installation package must be installed before installing any software components.

#### HSDAQ Component for Programming Language

The HSDAQ components are packaged according to the supported programming language.

The table below shows the HSDAQ components and their supported programming language.

Package Name	File Name	Programming Language
HSDAQ_Vnnnn.zip	HSDAQ.dll HSDAQ.lib HSDAQ.h	VC++
HSDAQNet_Vnnnn.zip	HSDAQNet.dll	VC#, VB.NET

### Tips & Warnings



The HSDAQ components can be updated by replacing the component files with the new HSDAQ components.

For full usage information regarding the description, prototype and the arguments of the functions, please refer to the “HSDAQ API Reference Manual” which can be obtained from.

<https://www.icpdas.com/en/download/show.php?num=2328>

## 7. Updates

The firmware is stored in flash memory and can be updated to fix functionality issues or add additional features, so we advise users to periodically check the ICP DAS web site for the latest updates.

### Step 1 : Get the latest version of the firmware

The latest version of the firmware can be obtained from ICP DAS download center at:

<http://www.icpdas.com/en/product/PET-AR-400>

### Step 2 : Run the HSDAQ Utility and connect to PET-AR400 by using the IP address

Enter the IP address in the IP field, and then click the Connect button to connect to the PET-AR400.

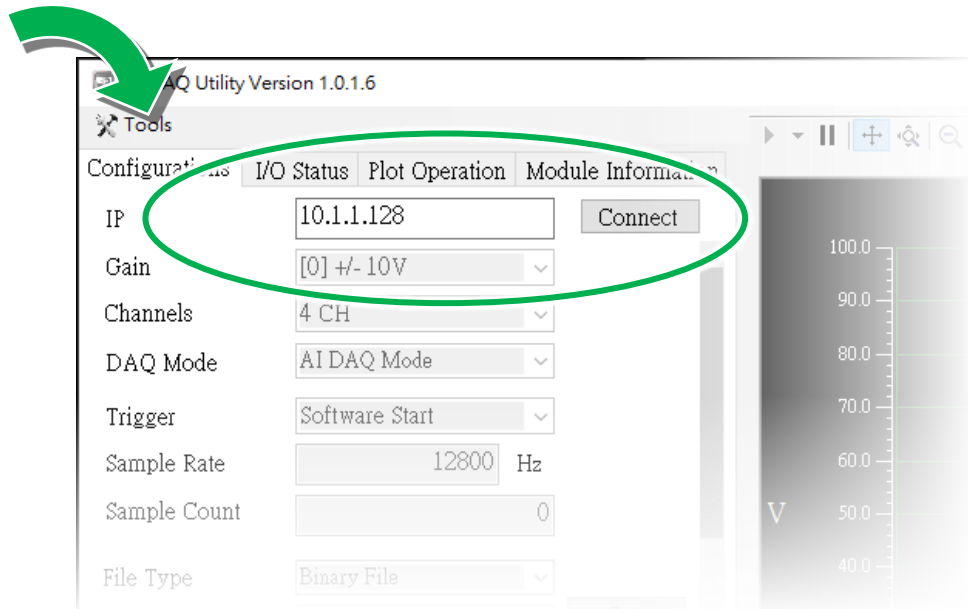
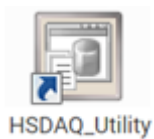

### Step 3 : Choose the upload Firmware option from the Tools menu

After choosing the “upload Firmware” option, the Upload Firmware dialog will appear.

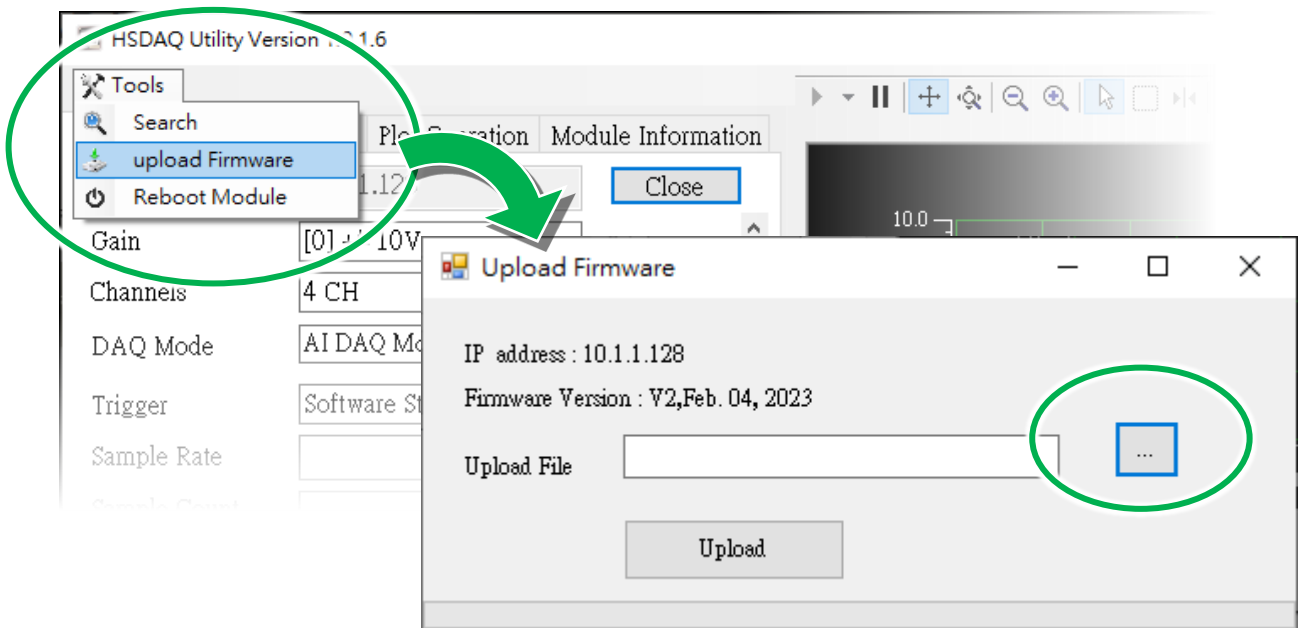

### Step 4 : Click the ... button to select the file that you downloaded, and then click the Upload button to start the upload process

Wait for the process bar to be filled and the following dialog box will to be displayed.

### Step 5 : Click the OK button to complete the process

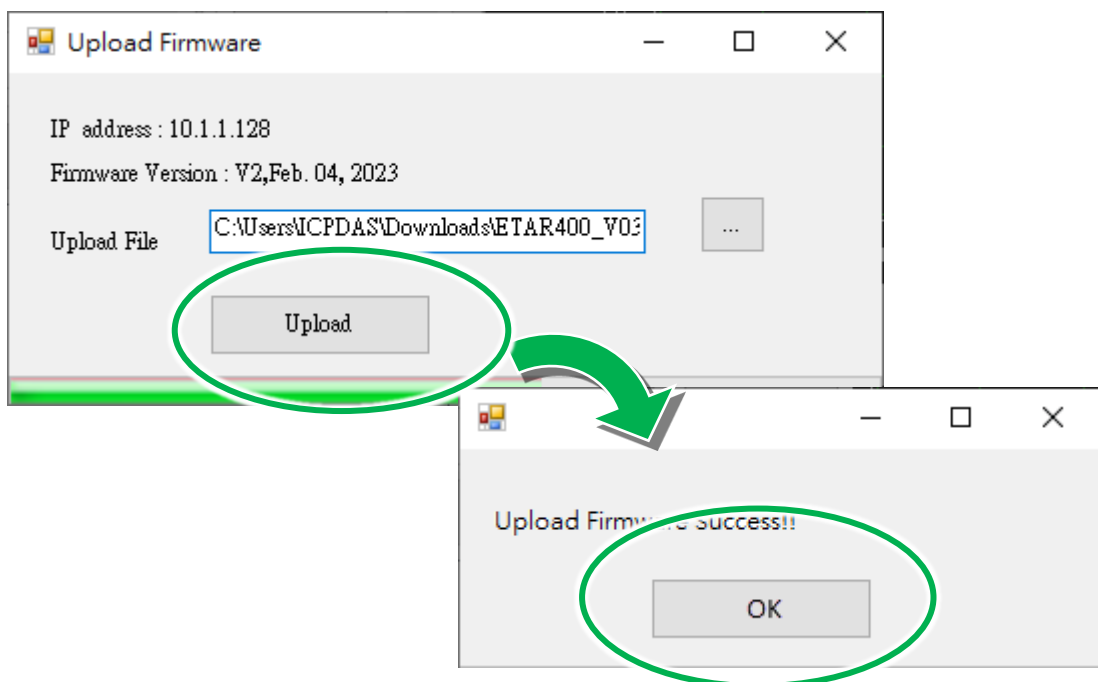

**Step 6 : Choose the Reboot Module option from the Tools menu for changes to take effect**

After choosing the “Reboot Module ” option, the Note! dialog will appear, and then click Yes button

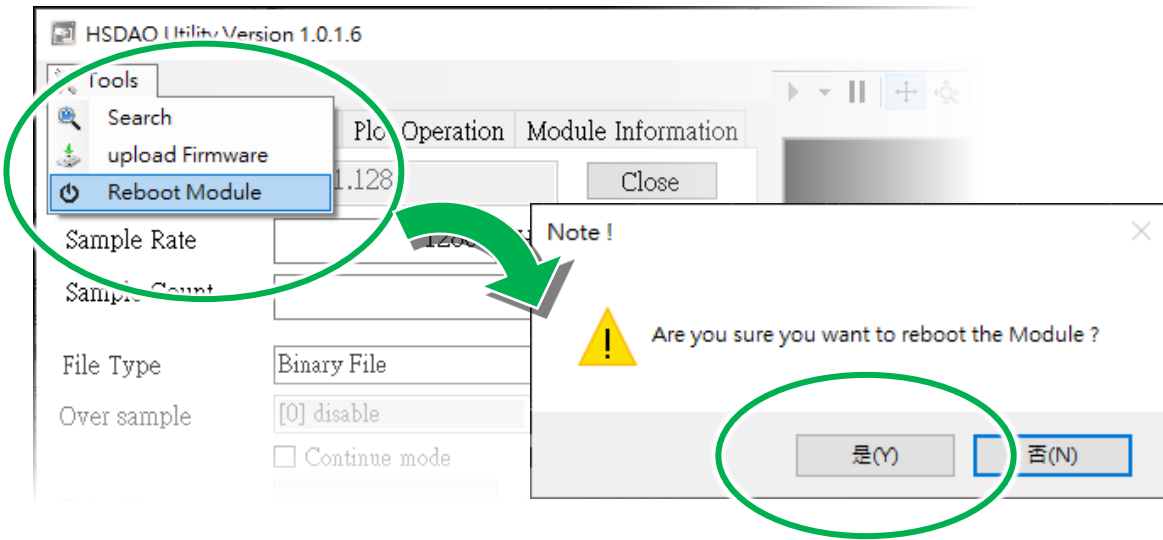

**Step 7 : Restart the HSDAQ Utility and then select the Module Information tab to check the current firmware version**

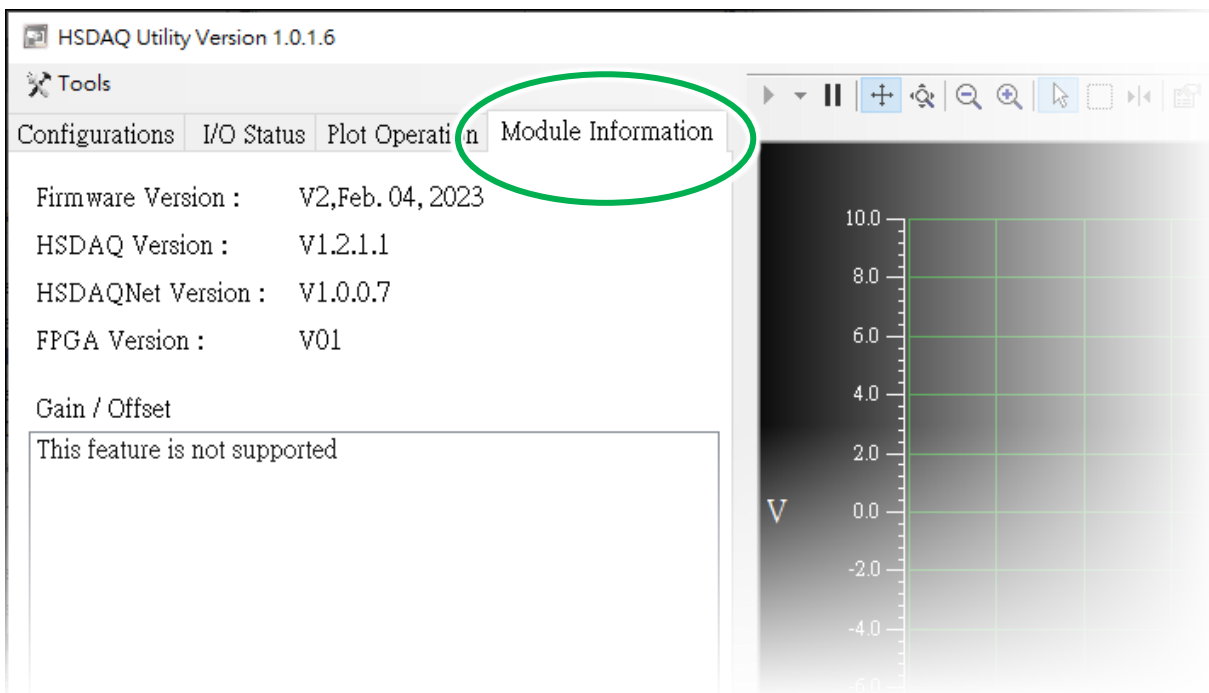

## 8. Calibration

PET-AR400 is calibrated and the calibration parameters, including the gain value and offset value, are stored in EEPROM when it is shipped. However, in certain extreme environments, more accurate voltage measurement may be required. In this case, a visual manual calibration method is provided.

### Step 1 : Prepare a high-precision signal generator and download the calibration software

The precision of the signal generator is the higher the better. The calibration tool can be obtained from:

<https://www.icpdas.com/en/product/PET-AR400>

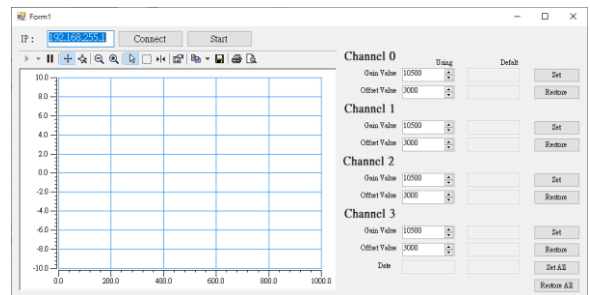

### Step 2 : Connect the signal generator to the channel to be calibrated

### Step 3 : Set the output of the signal generator

Set the signal generator to output a 102.4 Hz, 20Vpp sine wave to the channel that needs calibration.

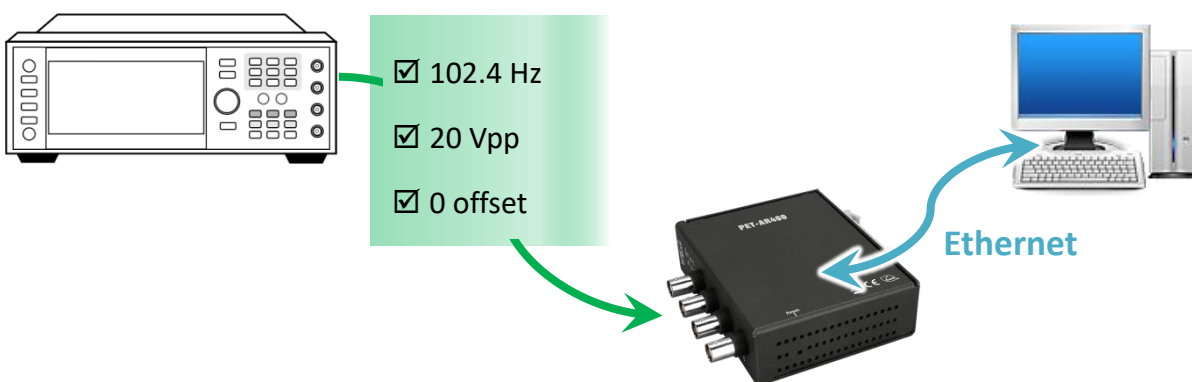

#### Step 4 : Run the calibration software and connect to PET-AR400 by using the IP address

Enter the IP address in the IP field, and then click the Connect button to connect to the PET-AR400.

If the connection is successful, the calibration value for each channel will be display.

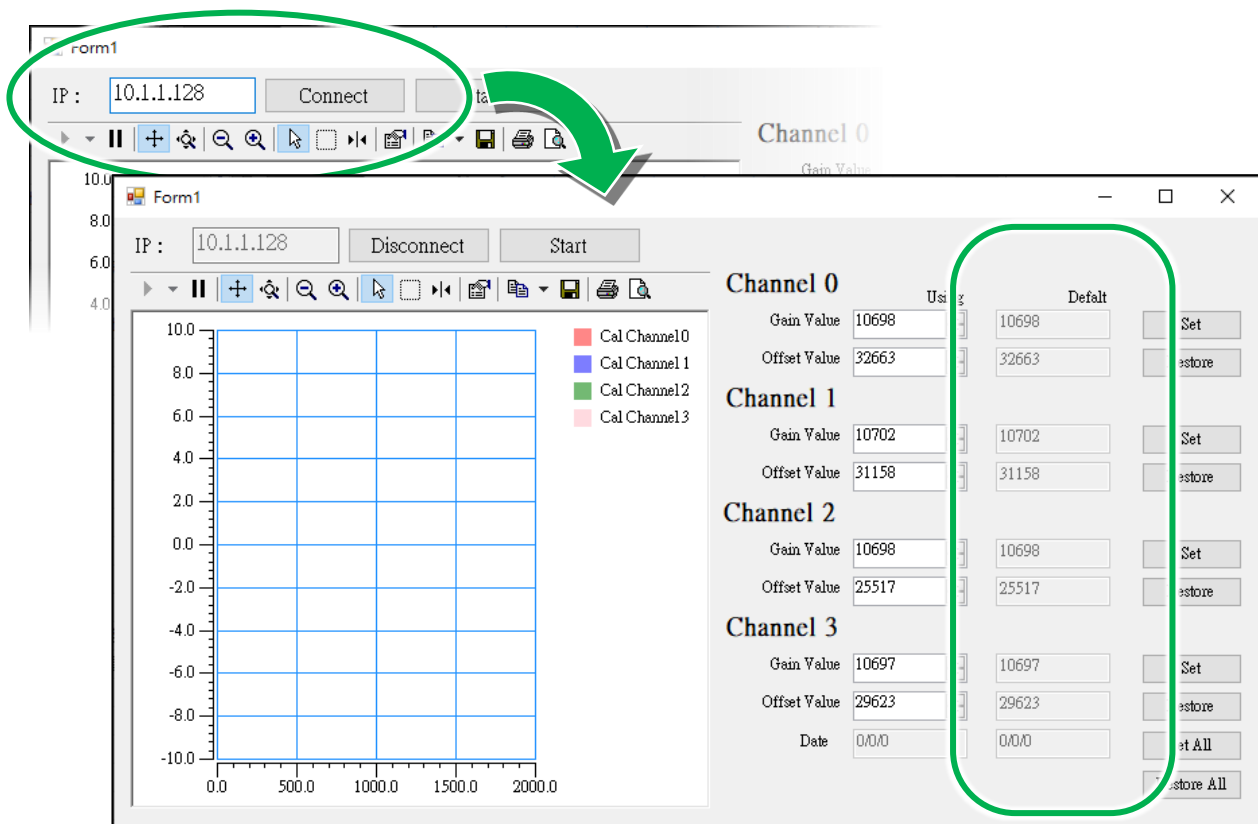

#### Step 5 : Start collecting data

Click the Start button to begin data acquisition. The program will configure the module to acquire data from four channels at a speed of 10.24 kHz.

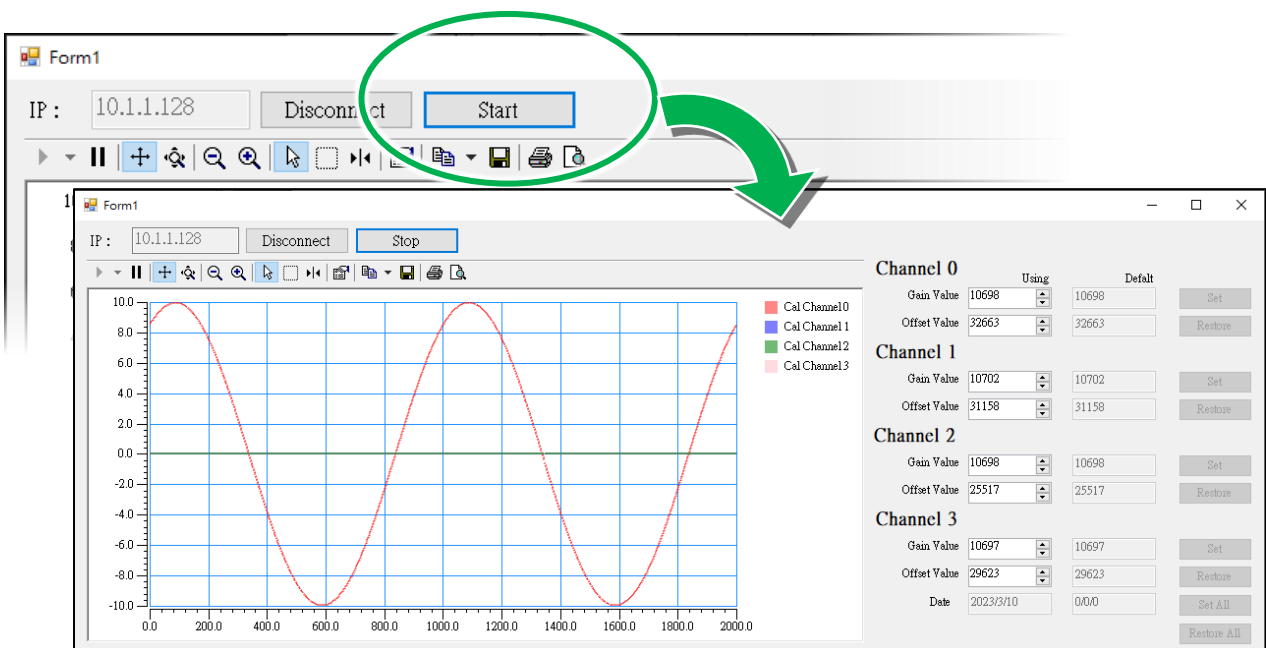

**Step 6 : Refer to the X-Y display chart and adjust the gain value and offset value to complete the calibration**

Adjust the gain and offset of the corresponding channel, and the program will display the modified results in real-time.

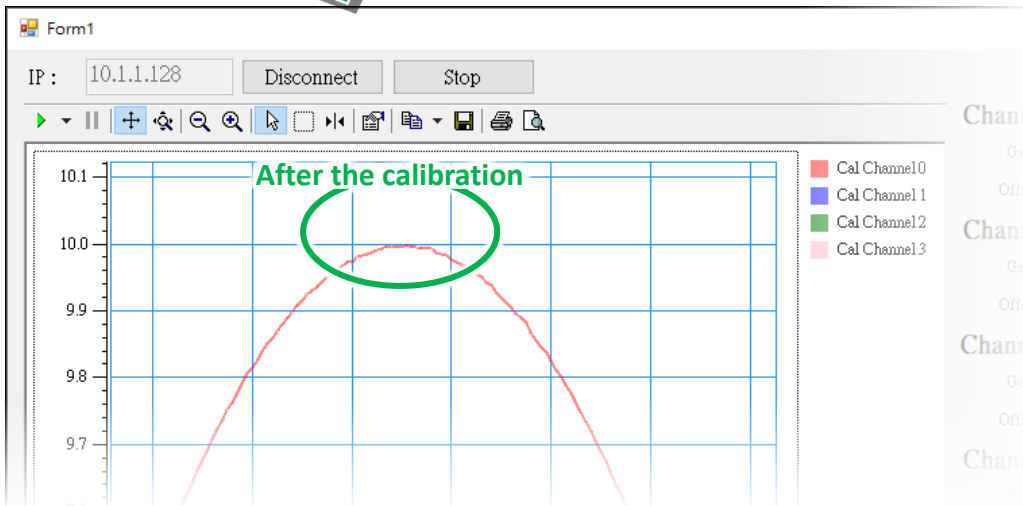
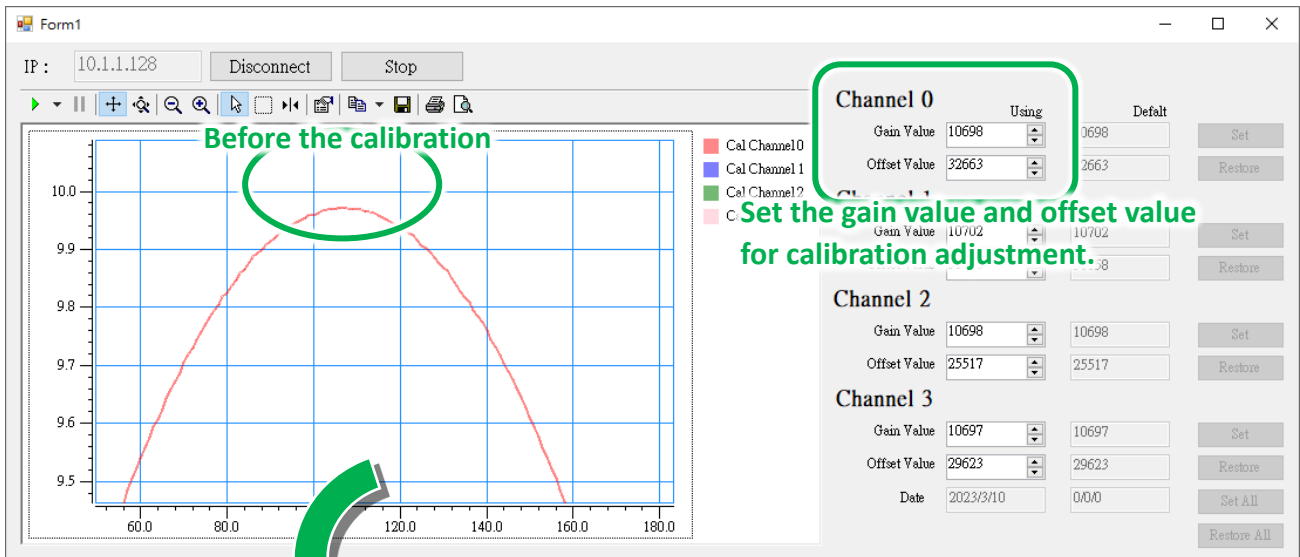

**Tips & Warnings**



Use the “Axes Zoom” on the tool bar to zoom in or zoom out will be help.





# Appendix

## A. Analog Input Type and Data Format

Type Code	Input Range	Data Format	+F.S	-F.S
00	-10 ~ +10V	Engineering Unit	+10000000	-10000000
		2's comp HEX	7FFFFFFFh	80000000h

- **Engineering Unit:**

The value gets from the software is 10000000 times of the real value.

**Example :**

Read data is 20000000 (Dec.) or 0 x 1312D00h (Hex.), it means the value is 2V.

Read data is 51860000 (Dec.) or 0 x 3175220h (Hex.) , it means the value is 5.186V.

Value Conversion:

$$Y1 = \frac{20000000}{10000000}$$

$$Y1 = 2V$$

Value Conversion:

$$Y2 = \frac{51860000}{10000000}$$

$$Y2 = 5.186V$$

- **2's Complement (Hex) :**

The value is usually displayed on the file or software in hexadecimal format. For example, "1460h" or "E000h" ("h" refers to hexadecimal). The values obtained from the software can be converted to actual values using the following formula.

**Example :**

Read data is 1526830688(Dec.) or 0x5B019660h(Hex.), it means the value is 7.1098V.

Read data is -1610576692(Dec.) or 0xA0008CCCh(Hex.) , which means the real value is -7.4998V.

Value Conversion:

$$\frac{Y1}{10} = \frac{1526830688}{2147483647}$$

$$Y1 = 7.1098V$$

Value Conversion:

$$\frac{Y2}{-10} = \frac{-1610576692}{-2147483648}$$

$$Y2 = -7.4998V$$

## B. Troubleshooting

A number of common problems are easy to diagnose and fix if you know the cause.

Symptom/Problem	Possible cause	Solution
Cannot communicate via the Ethernet port, but the module is still working.	The IP/Mask/Gateway address isn't within the IP address range of the LAN.	Change the IP/Mask/Gateway address to match the LAN, or ask the MIS administrator for assistance.
	The IP address has restricted by the IP filter settings.	Check the IP filter setting using the Web configuration.
	There are more than 30 TCP/IP connections.	Reboot the module.
Able to explore the web page through port 80 using a web browser, but Modbus/TCP program cannot access the module through port 502.	Port 502 has been restricted by the firewall.	Consult your MIS administrator for assistance.
Modbus/TCP program can access the module through port 502, but Web browser cannot explore the web page through port 80 using a web browser.	The Port 80 has restricted by the firewall.	Consult your MIS administrator for assistance.
	The Web Configuration function has been disabled. (Shown on the Basic Settings page)	Enable the Web Configuration function using either the SMMI or the console.
	The Web server TCP port has been changed from port 80 (Shown on the Basic Settings page)	Change the TCP port to 80 or reconnect the PET-7H24M using the specific TCP port.

## C. Applications

### C.1. Raspberry Pi Application

The Raspberry Pi open hardware creates diversified and customized applications in the age of Internet of Things.

With python (the most popular development tool for the IoT) or Microsoft's cross-platform development tool .Net, it can provide products and various services more quickly.

Raspberry Pi users use the python/.Net library and sample programs provided by the ICP DAS high-speed data acquisition module platform to connect to the PET-7H16M/PET-7H24M to collect high-speed data for data analysis and IoT applications.

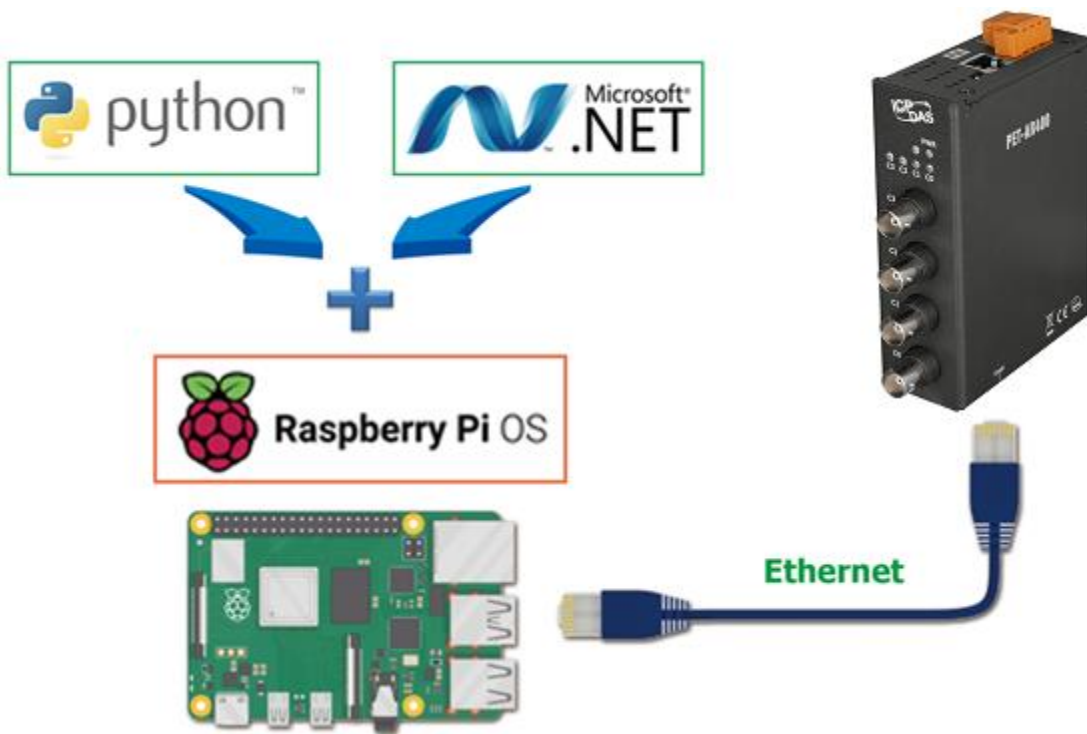

## C.2. Vibration High Speed Measurement Application

PET-AR400 can be connected to an IEPE Accelerometer to convert the signal into an analog voltage output with a general measurement range, and then transmit it to the data center system for processing and analysis through the Ethernet network.

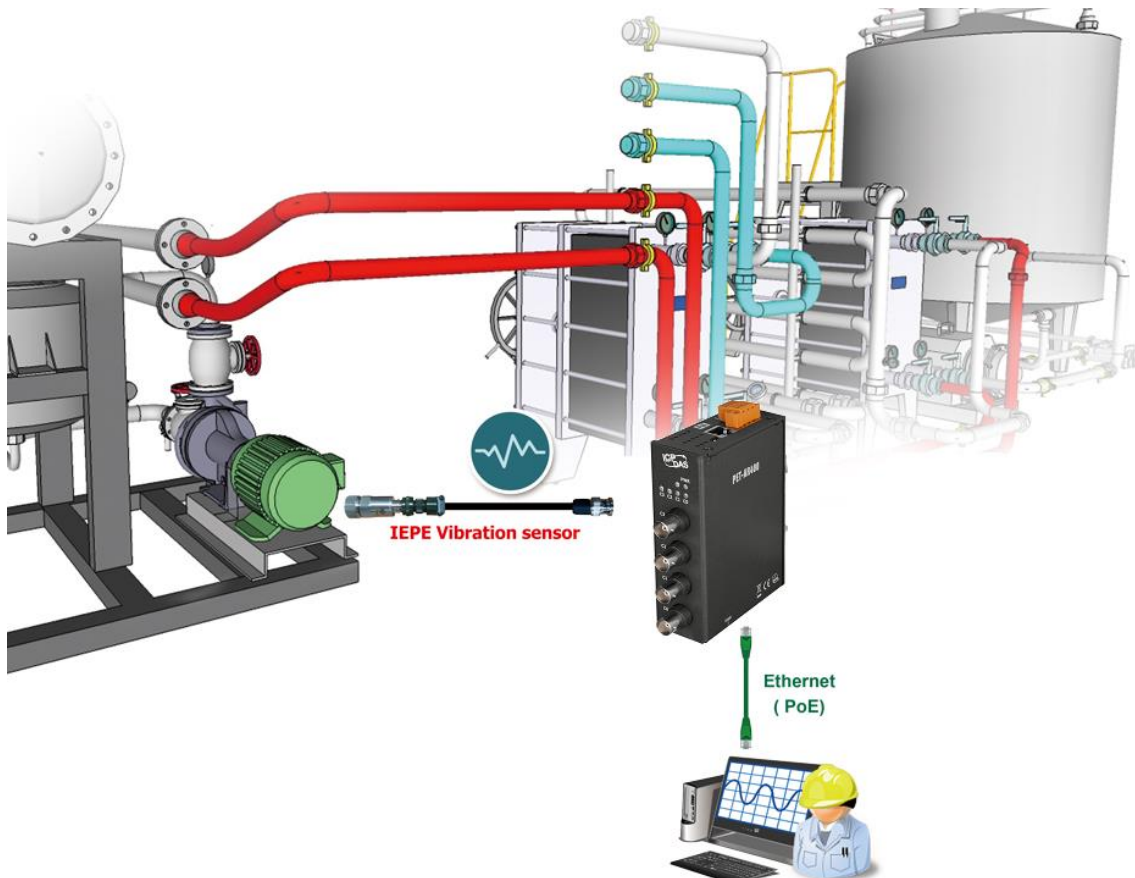

## D. Revision History

This chapter provides revision history information to this document.

The table below shows the revision history:

Revision	Date	Description
1.0.0	November 2022	Initial Issue