



PET-AR400

Ethernet High Speed Data Acquisition Module with PoE and 4-ch 24-bit Simultaneously IEPE Input

Features

- 4 differential IEPE input, Excitation Current 4 mA
- 24-bit ADC
- Sample Rate up to 128 kS/s (one channel)
- LED indicator support
- Metal shell and 4 kV ESD protection
- A/D Trigger Mode : Software Trigger/Analog Threshold Trigger
- Option for External Power Supply or POE Supply



Introduction

PET-AR400 is a high speed data acquisition device with a built-in Ethernet communication port for data transfer over a network, and includes 4 high-speed 24-bit differential IEPE input channels (128 kHz sample and hold @ one channels).

PET-AR400 also provides 4 kV ESD protection as well as 2500 VDC intra-module isolation. In addition, the 24-bit ADC includes built-in filtering to adjust the appropriate sampling rate and filter out modulator and signal noise. The PET-AR400 is not only suitable for a wide range of mobile/portable measurement applications, but also for precision signal measurement.

The software trigger mode can command the trigger to perform continuous or N data A/D acquisition when needed, on the other hand, when the trigger mode is set to Analog Threshold Trigger mode, the A/D will start collecting N data when the analog input value is above or below a certain voltage.

A/D Trigger Mode	Data Transmission Mode	Total simultaneous sampling channels	Maximum sampling rate
Software A/D Data Acquisition Mode	Continuous Transmission	1	12.8k/16k/32k/64k/128k Hz
		2	12.8k/16k/32k/64k Hz
		3/4	12.8k/16k/32k Hz
Analog Threshold Trigger Mode	N Sample Acquisition	1	12.8k/16k/32k/64k/128k Hz
		2	12.8k/16k/32k/64k Hz
		3/4	12.8k/16k/32k Hz

System Specifications

Software	
OS	Windows 7/8/10 and Linux
Utility	Configuration, graphically display and data logging
SDK	Windows <ul style="list-style-type: none"> • Microsoft VC, C#, VB.NET SDK API and Demo • Python Demo • NI LabVIEW Toolkit and Demo Linux <ul style="list-style-type: none"> • C/C++ library and Demo • .NET library and Demo • Python Demo
Communication	
Ethernet	1 x RS-45, 10/100 Base-TX
PoE	IEEE 802.3af, class 2
Security	ID, Password and IP Filter
Protocol	TCP Streaming (Access data by SDK library), Modbus TCP
LED Indicators	
Status	1 x Power, 4 x Connection

EMS Protection	
ESD (IEC 61000-4-2)	4 kV Contact for each terminal and 8 kV Air for random Point
EFT (IEC 61000-4-4)	1 kV for power
Power	
Reverse Polarity Protection	Yes
Powered from Terminal Block	+12 ~ +48 VDC
Consumption	4.5 W
Mechanical	
Dimensions (W x L x H)	33 mm x 120 mm x 108 mm
Installation	DIN-Rail, Wall Mounting
Casing	Metal
Environmental	
Operating Temperature	-25 °C ~ +75 °C
Storage Temperature	-30 °C ~ +80 °C
Humidity	10 ~ 90 % RH, Non-condensing

I/O Specifications

IEPE Input	
Channels	4 Differential (Simultaneously)
Resolution	24-bit
Range	±10 V
Accuracy	±0.02 % of FSR @ ±10 V
Sampling Rate	32 kHz @ 3/4 channels 64 kHz @ 2 channels 128 kHz @ 1 channel
Input Impedance	2 MΩ
FIFO Size	1 k bytes, 256 Samples
Trigger Mode	Software, Analog Threshold Trigger
Excitation Current	4 mA (IEPE compliance: 24 V)
Input Common Mode Range	±10 V
Input Coupling	AC coupling
Cutoff Frequency	0.16 Hz
Input Bandwidth	12.8 kHz (-0.1 db) @ 1/2 channel(s) 6.4 kHz (-0.1 db) @ 3/4 channels
Connectors	BNC (female)

Dimensions

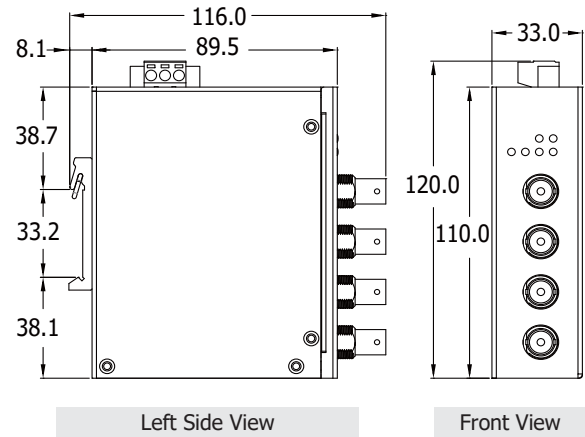

Appearance

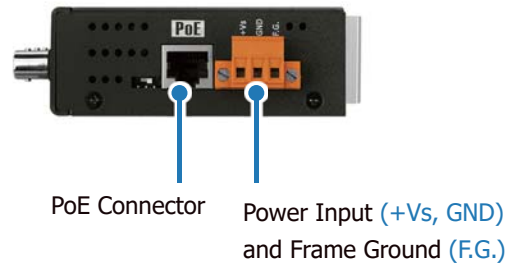
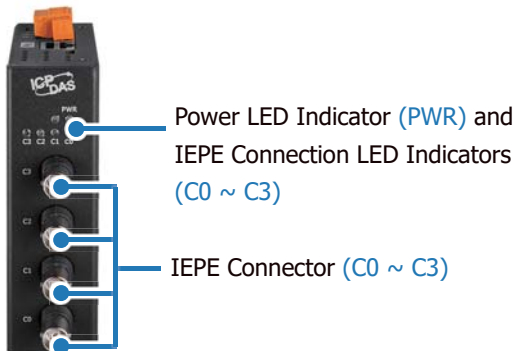

Wire Connections

	IEPE Accelerometers iSN-701-BALT-F15-L030	DAQ Module PET-AR400
		→ C3
		→ C2
		→ C1
		→ C0

Features

1 Data Transmission Mode

1. Continuous transmission (Maximum sampling rate : 32 kHz@ 4 channels; 128 k Hz@ 1 channel)

After starting A/D acquisition, data is continuously transmitted to the Host PC.



2. After collecting N samples, the data is transferred to the host PC

(Maximum sampling rate : 32 kHz@ 4 channels; 128 k Hz@ 1channel)

(a) After starting A/D acquisition, the data will be temporarily stored in the memory in the module, and wait until a command is received from the Host PC, before transferring the collected data to the Host PC

(b) The memory capacity allows temporary storage of up to 1500 million data samples.

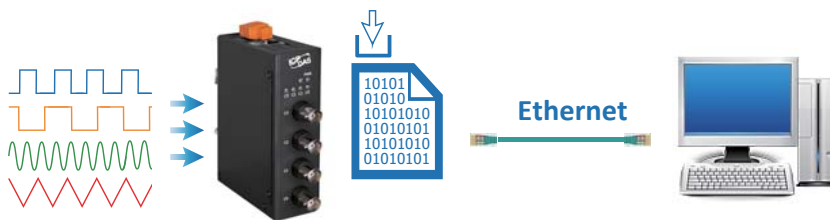

2 A/D trigger mode

1. Software AD Data Acquisition mode

The A/D acquisition parameters are configured via a command from the Host PC. The continuous A/D acquisition or the acquisition of N data samples begins after the command is triggered.

2. Analog Threshold Trigger

Analog Threshold Trigger is triggered when the voltage signal of the specified analog input channel is higher or lower than a certain voltage setting. In addition, the user can also specify the trigger voltage level range of the input signal. Once the signal leaves the high and low level region or the signal enters the high and low level region, it is triggered to start the acquisition.

1. Above High: The signal is triggered above the high level and collects N data.
2. Below Low: The signal is triggered below the low level and collects N data.

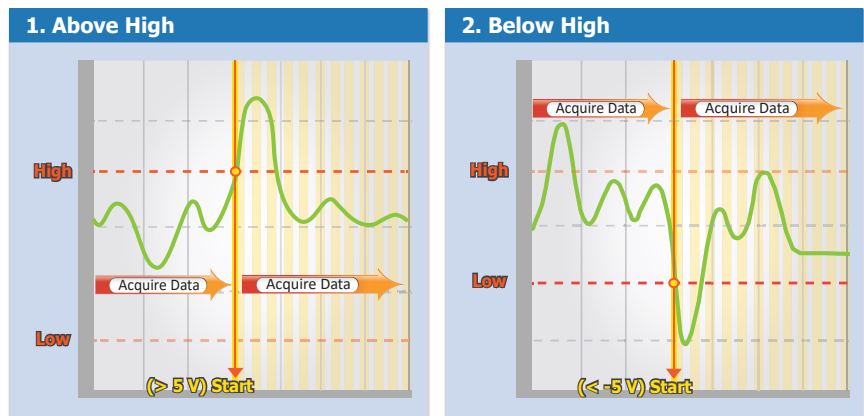

3. Leave-region: Trigger when the signal leaves the high and low level region, collect N data.

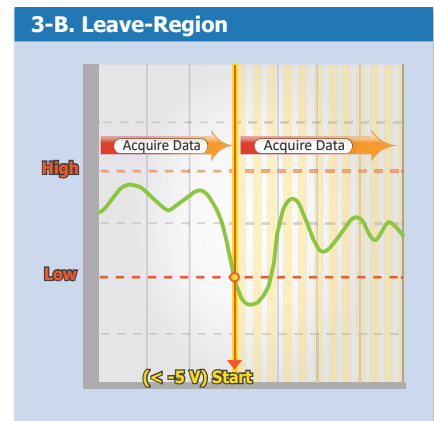
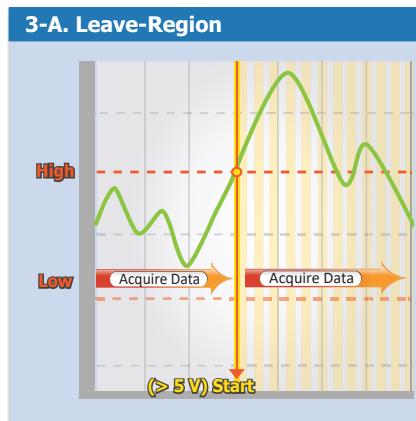

4. Entry-region: Trigger when the signal enters the high and low level region, collect N data.

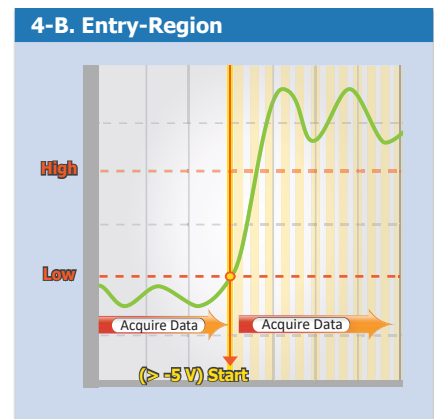
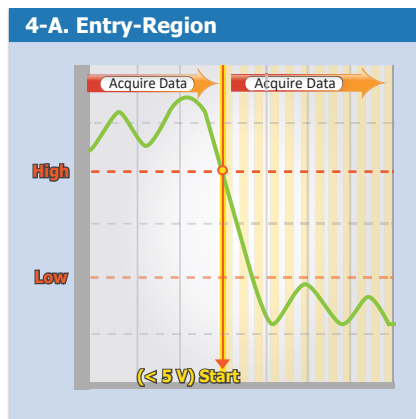

3 PC Software Support

Windows

- Microsoft VC, C#, VB.NET SDK API and demo
- Python demo
- NI LabVIEW Toolkit and demo

Linux

- C/C++ library and demo
- .NET library and demo
- Python demo

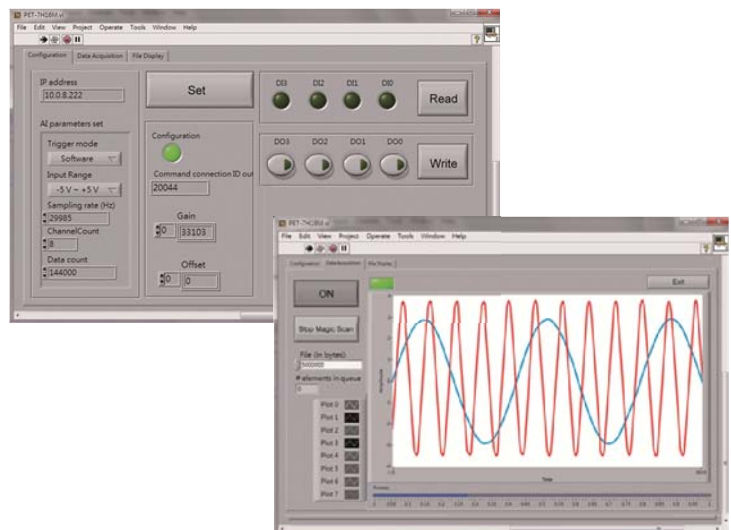

Ordering Information

PET-AR400 CR Ethernet High Speed Data Acquisition Module with PoE and 4-ch 24-bit Simultaneously IEPE Input (RoHS)