

---

# *WF-2572/WF-2572M*

## *Ethernet to Wi-Fi Bridge*

User Manual v1.10



[www.icpdas.com](http://www.icpdas.com)



---

## **Information**

### **Warranty**

---

All products manufactured by ICP DAS are under warranty regarding defective materials for a period of one year from the date of delivery to the original purchaser.

### **Waring**

---

ICP DAS assumes no liability for damages resulting from the use of this product. ICP DAS reserves the right to change this manual at any time without notice. The information furnished by ICP DAS is believed to be accurate and reliable. However, no responsibility is assumed by ICP DAS for its use, or for any infringements of patents or other rights of third parties resulting from its use.

### **Copyright**

---

Copyright 2018 by ICP DAS. All rights are reserved.

### **Trademark**

---

The names used for identification only may be registered trademarks of their respective companies.

### **Technical Support**

---

If you have any problems, feel free to contact us via e-mail at [service@icpdas.com](mailto:service@icpdas.com)

### **Document Revision**

Version	Date	Note
1.00	2018/09/30	Release version
1.10	2018/08/30	Add WF-2572M of feature

---

# Content

<b>1. INTRODUCTION</b>	<b>5</b>
1.1 FEATURE	6
1.2 UTILITY	6
<b>2. HARDWARE</b>	<b>7</b>
2.1 SPECIFICATIONS	7
2.2 WF-2572 SERIES APPEARANCE	8
2.2.1 Front Panel of WF-2572	8
2.2.2 Front Panel of WF-2572M	9
2.2.3 Top Panel	10
2.2.4 LED Indicator	11
2.3 POWER WIRE CONNECTION	12
2.4 WATCHDOG TIMER SETTING	12
2.5 FW / OP DIP-SWITCH	12
2.5.1 Firmware update mode	12
2.5.2 Firmware Operation Mode	14
2.6 DIMENSIONS	14
2.6.1 Dimensions of WF-2572	14
2.6.2 Dimensions of WF-2572M	15
<b>3. SOFTWARE</b>	<b>16</b>
3.1 WIRELESS CONFIGURATION TOOL – WF-2572 UTILITY	16
3.2 WF-2572 UTILITY	16
3.3.1 Wi-Fi Parameter	17
3.3.2 Device MAC	17
3.3.3 IP Setting	18
<b>4. APPLICATION SETTING</b>	<b>18</b>
4.1 SYSTEM ARCHITECTURE OF INFRASTRUCTURE MODE	18
4.2 SYSTEM ARCHITECTURE OF LIMIT-AP MODE	19
4.3 HARDWARE INSTALLATION	20
4.4 INFRASTRUCTURE SETTING DESCRIPTION	20
4.4.1 Test Architecture	20
4.4.2 Setting step	21
4.4.3 Query device MAC by using WF-2572 utility	22
4.5 LIMIT-AP MODE	24

---

4.5.1	<i>Test Architecture</i> .....	24
4.5.2	<i>Setting step</i> .....	24
<b>5.</b>	<b>TECHNICAL SUPPORT</b> .....	<b>26</b>

# 1. Introduction

The WF-2572/WF-2572M is an industrial Ethernet to Wi-Fi Bridge. The device only needs to connect the Ethernet cable with WF-2572/WF-2572M that can create an IEEE 802.11 a/b/g wireless personal network. The interface between Ethernet and Wi-Fi use transparent transmission so that it can convert Wi-Fi to wire internet without complex settings. The WF-2572/WF-2572M also supports dual bands (2.4/5 GHz). The 2.4 GHz is more crowded than 5 GHz. Therefore, the devices on 2.4 GHz suffer much more interference than the ones on 5 GHz. The WF-2572/WF-2572M has less interference on 5 GHz.

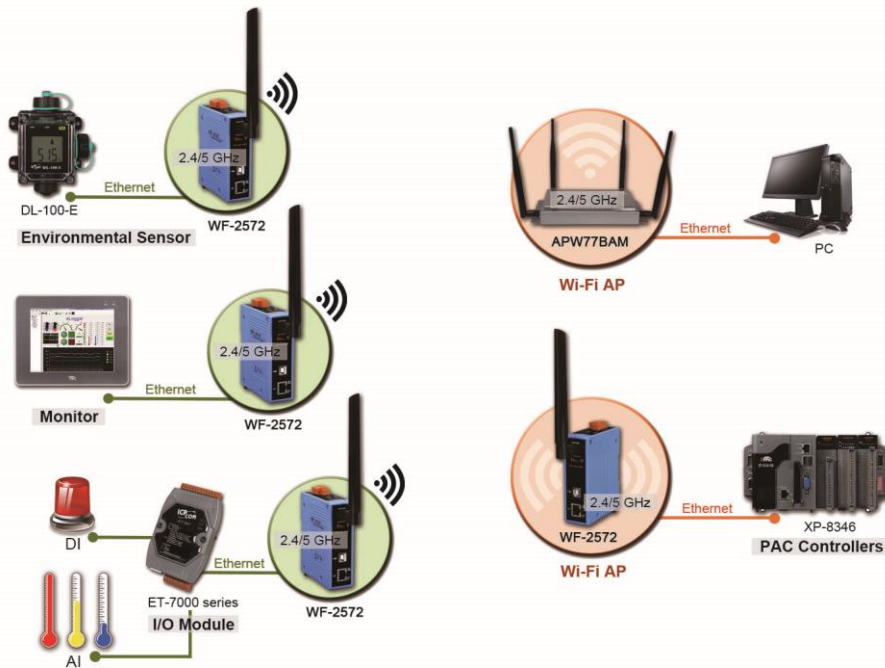

Figure 1-1. The application architecture of WF-2572

## 1.1 Feature

- Frequency: 2.4/5 GHz
- Full compatible with IEEE 802.11 a/b/g
- Support Wi-Fi Limit-AP and Infrastructure mode
- Support WPA-PSK, WPA2-PSK for Wi-Fi encryption
- Plug-and-Play Ethernet to Wi-Fi connectivity
- USB-based configuration
- No driver installation required
- Built-in Watchdog
- Metal case(WF-2572M)
- Extended operating temperature range (-25°C ~ +75°C)

## 1.2 Utility

- Configuration by USB interface
- Support setting of Wi-Fi Infrastructure and Limit-AP mode

WF-2572 Utility

Wi-Fi Parameter

Mode: Infrastructure      SSID: WF-2572

Operation Band: 2.4 GHz      Authentication: WPA/WPA2

Channel: 11      Password: 1qaz2wsx

MAC

MAC: FF : FF : FF : FF : FF : FF      Get MAC

The MAC only can modify when the mode is "Station".

IP

IP: 192 168 255 1

Submask: 255 255 255 0

Gateway: 192 168 255 1

Firmware Information

Version:

FW Date:

Write Setting      Read Setting

Utility Version: V1.00

Figure 1-2. WF-2572 Utility

## 2. Hardware

### 2.1 Specifications

Item	WF-2572	WF-2572M
<b>RF Specification</b>		
Standard	IEEE 802.11 a/b/g	
Frequency	2.4 GHz: CH1~11 5 GHz: CH36、40、44、48	
Operation mode	Limit-AP / Infrastructure	
Encryption	Open/WPA/WPA2	
Antenna	Omni-Directional 3 dBi @ 2.4 GHz 5.5 dBi @ 5 GHz	
Transmission Range	50 m (LOS)	
<b>Ethernet</b>		
Controller	100Base-TX Ethernet Controller (Auto-MDIX)	
Connector	RJ-45 with LED indicator	
<b>USB Interface</b>		
Type	USB 2.0 Full-Speed	
Connector	USB type B	
<b>LED Indicator</b>		
System status	3 Indicator LEDs (PWR, LINK, COMM)	
Signal strength	3 Indicator LEDs (High, Mid, Low)	
<b>Power</b>		
Input Voltage Range	10 ~ 30VDC	
Power Consumption	1.6 W	
<b>Mechanism</b>		
Casing	Plastic	Metal
Installation	DIN-Rail	
Dimensions	33mm x 95mm x 120mm (W x L x H)	33mm x 108mm x 120mm (W x L x H)
<b>Environment</b>		
Operation Temp.	-25°C ~ +75°C	
Storage Temp.	-30°C ~ +80°C	
Humidity	10~90%	

---

## 2.2 WF-2572 Series Appearance

### 2.2.1 Front Panel of WF-2572

The WF-2572 front panel contains the antenna, USB connector, Ethernet connector and LEDs.

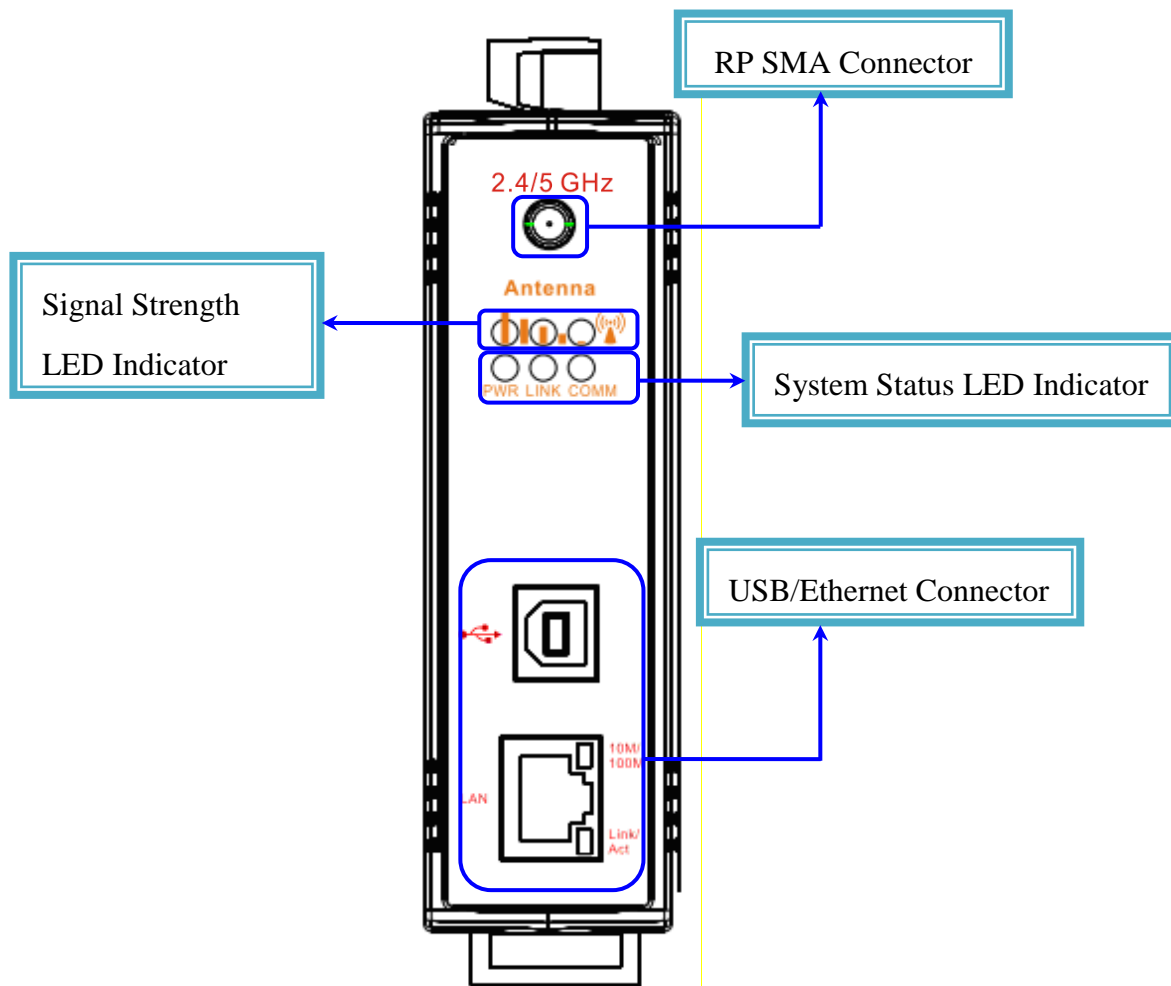

Figure 2-1. Front Panel of the WF-2572



## 2.2.2 Front Panel of WF-2572M

The WF-2572M front panel contains the antenna, USB connector, Ethernet connector, Power connector, operating mode selector switch and LEDs.

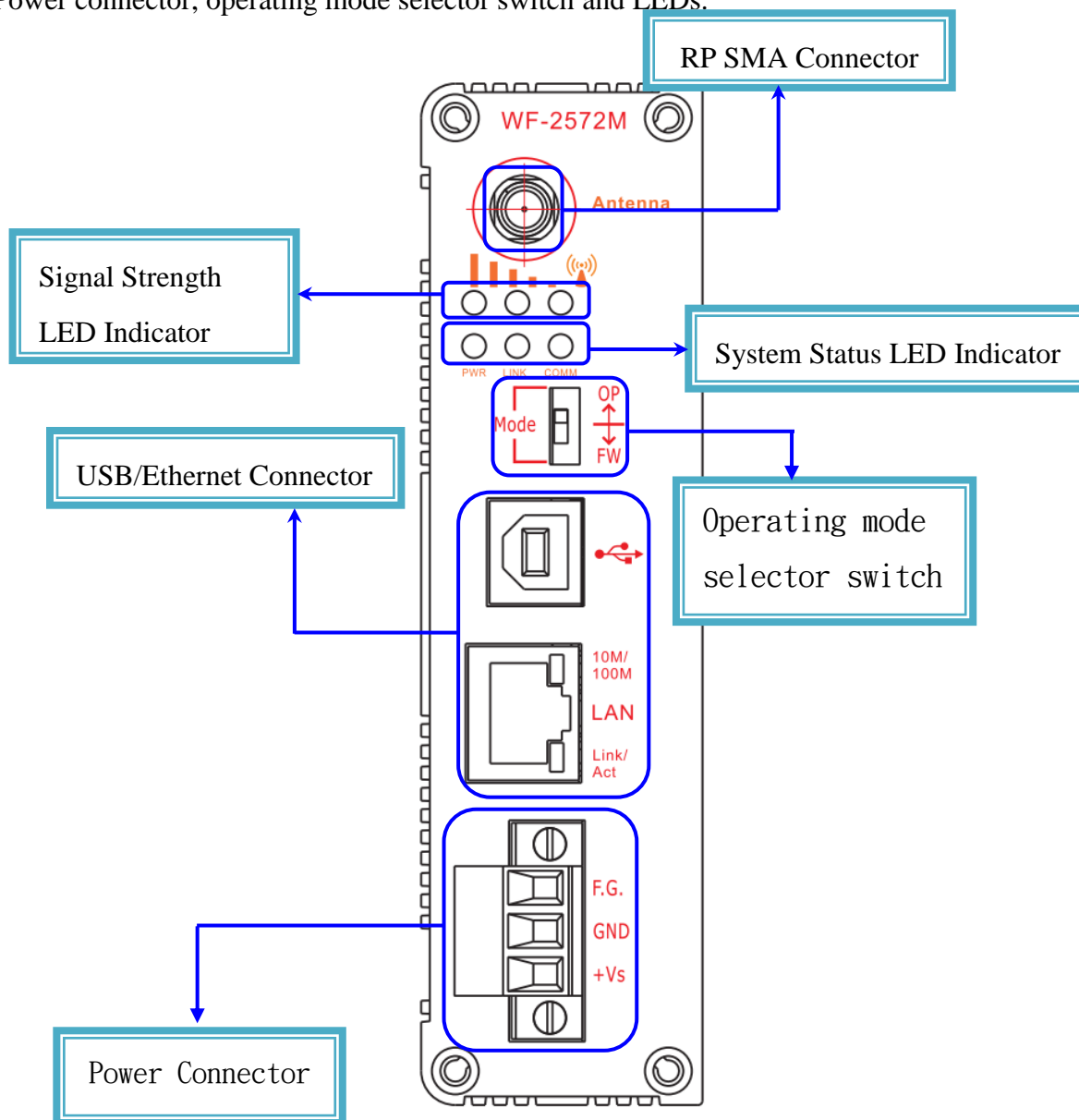

Figure 2-2. Front Panel of the WF-2572

Table 2-1. Power Connector

Power Connector	
Pin Assignment	Description
F.G	Frame Ground
GND	Power GND
+Vs	+10 ~ +30 VDC

### 2.2.3 Top Panel

The WF-2572 top panel contains the power connector and operating mode selector switch.

- FW mode: Firmware update mode
- OP mode: Firmware operation mode

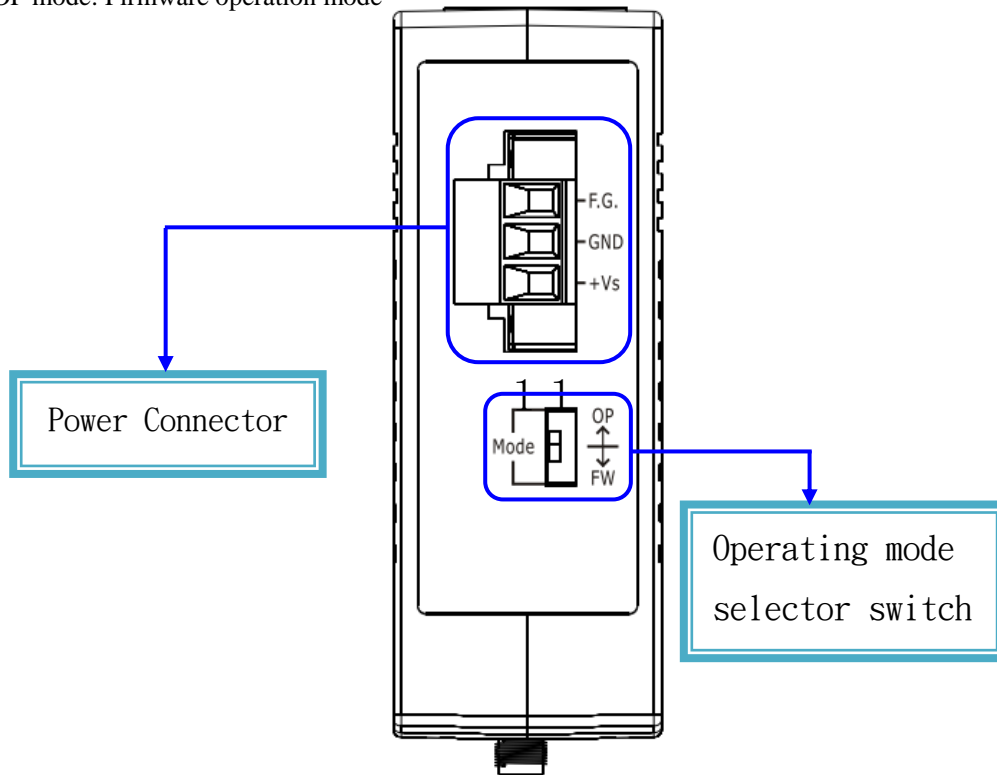

Figure 2-3. Top Panel of WF-2572





Table 2-2. Power Connector

Power Connector	
Pin Assignment	Description
F.G	Frame Ground
GND	Power GND
+Vs	+10 ~ +30 VDC

## 2.2.4 LED Indicator

The LED Indicator can be divided into two types. The one is signal strength indicator. The other is system status indicator. The description of the LED indicator as shown in Table 2-3.

Table 2-3. The description of LED indicator

LED	LED Status	Description
Limit-AP mode		
Signal strength-Green	Always ON	Device at Limit-AP mode
Signal strength-Yellow	Always ON	AP at 2.4 GHz
	OFF	AP at 5 GHz
Power (PWR)	Always ON	Power Good
	OFF	Power failure
Connection Status(LINK)	Blink/Always ON	Unconnected
	OFF	Connected
Communication(COMM)	Blink	Data transmission
	OFF	Bus Idle
Infrastructure mode		
Signal strength		Signal strength: High
		Signal strength: Medium
		Signal strength: Low
		Unconnected
Power (PWR)	Always ON	Power Good
	OFF	Power failure
Connection Status(LINK)	Blink/Always ON	Unconnected
	OFF	Connected
Communication(COMM)	Blink	Data transmission
	OFF	Bus Idle

### 2.3 Power wire connection

The power wire connection of WF-2572 has shown in Figure 2-4.

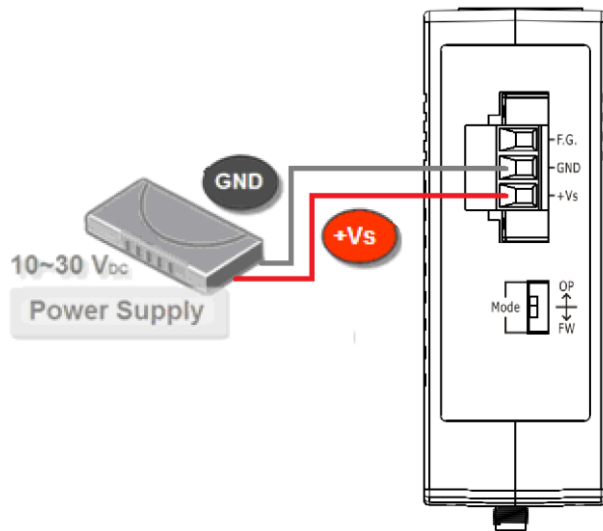

Figure 2-4. Power wire connection of WF-2572

### 2.4 Watchdog Timer Setting

A watchdog timer (WDT) is a device that performs a specific operation after a certain period of time if something goes wrong and the system does not recover on its own. A watchdog timer can perform a warm boot (restarting the system) after a certain number of milliseconds.

The WF-2572 supplies a jumper for users to activate the watchdog timer or not. Inside the WF-2572 users can use the JP1 to activate the WDT built in the module, as the Figure 2-5. Note that the default setting is active.



Figure 2-5. Watchdog Setting

### 2.5 FW / OP Dip-switch

On the top of the WF-2572 series module, there is a dip-switch used for firmware operation or firmware update modes selection of the module.

#### 2.5.1 Firmware update mode

As shown in Figure 2-6, it need to set the dip-switch to the “FW” position after that the WF-2572 will work in the “Firmware Update Mode” after reset the power. In this mode, users

can update the firmware of the WF-2572 via USB interface and it will become a “USB Mass Storage Device” and shows a folder automatically.

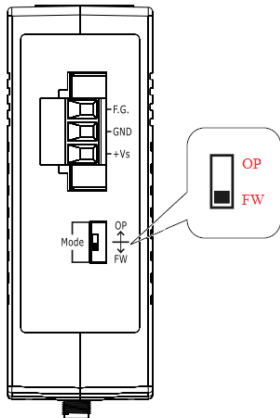

Figure 2-6. FW update position of Dip-Switch



Figure 2-7. USB Mass Storage Device

Users just need to execute “Firmware\_Update\_Tool.exe” and follow the below steps to complete the firmware updating process.

**Step1.** Choose “USB” interface and “USB Disk”.

**Step2.** Click “Browser” button to choose firmware file. (e.g. WF2572\_V100.fw)

**Step3.** Click “Firmware Update” button to start firmware updating process.

The result will be showing in “Firmware Update” field.

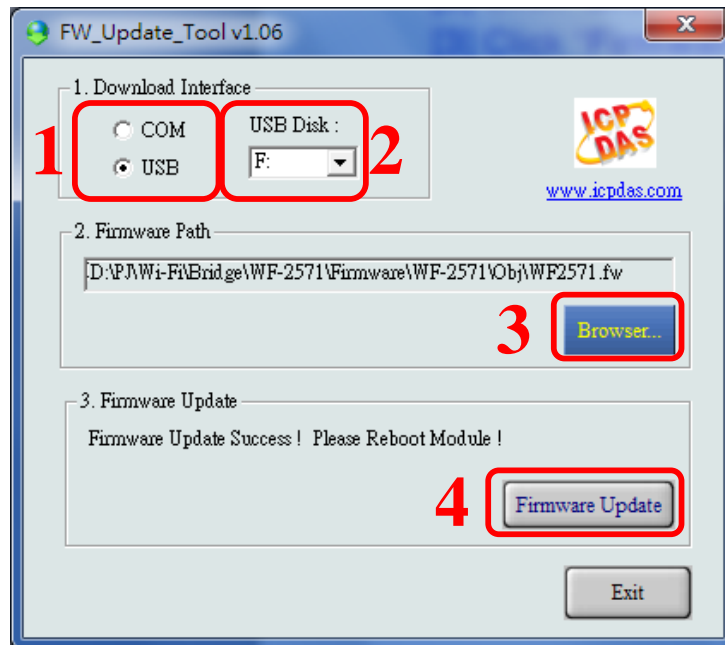

Figure 2-8. WF-2572 firmware update process

The WF-2572 firmware can be downloaded from

<ftp://ftp.icpdas.com/pub/cd/usbcd/napdos/wifi/WF-2572/firmware/>

---

The Firmware\_Update\_Tool can be downloaded from

<ftp://ftp.icpdas.com/pub/cd/usbcd/napdos/wifi/WF-2572/software/tool/>

### 2.5.2 Firmware Operation Mode

As shown in Figure 2-9, Users need to set the dip-switch to the “OP” position and reset the power, which the WF-2572 can run in the operation mode. In this mode, user can use the WF-2572 with a computer or other devices that have Ethernet interface for wireless connection.

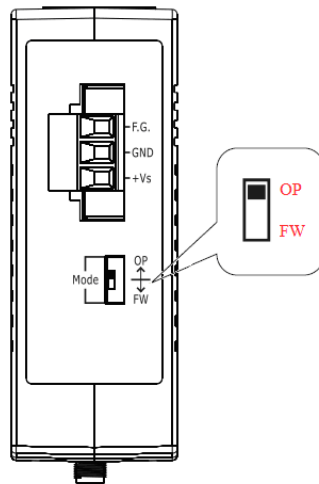

Figure 2-9. OP Position of Dip-Switch

## 2.6 Dimensions

The diagrams below provide the dimensions of the WF-2572 series to use in defining your enclosure specifications. All dimensions are in millimeters.

### 2.6.1 Dimensions of WF-2572

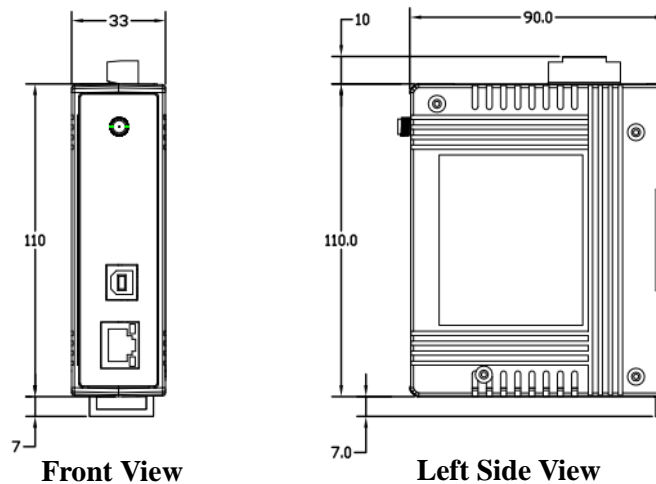

Figure 2-10. Front / Left side dimension of the WF-2572

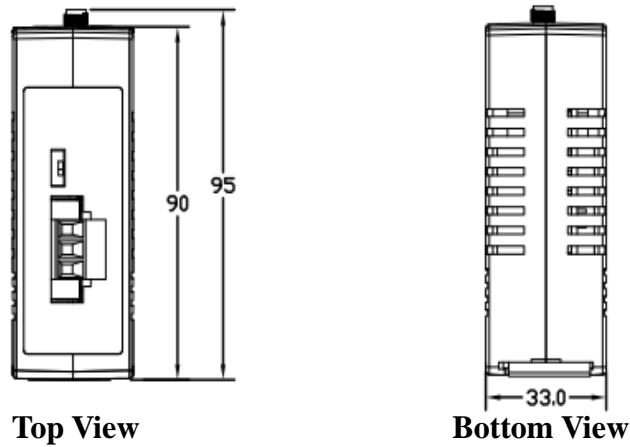

Figure 2-11. Top / Bottom side dimension of the WF-2572

### 2.6.2 Dimensions of WF-2572M

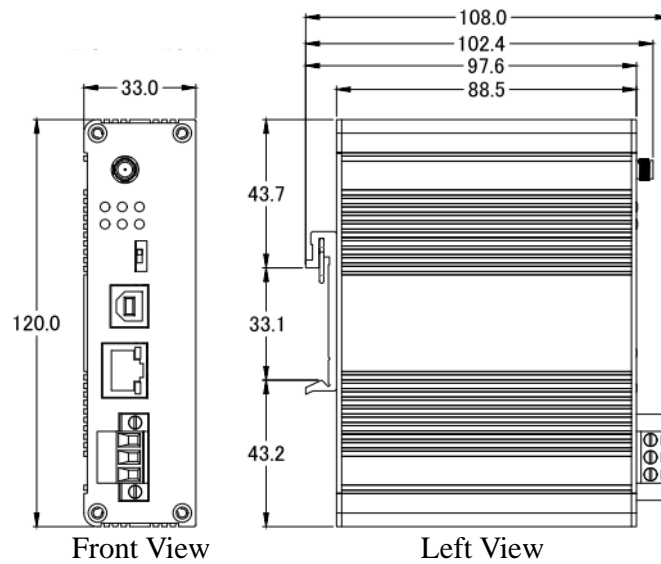

Figure 2-12. Front / Left side dimension of the WF-2572M

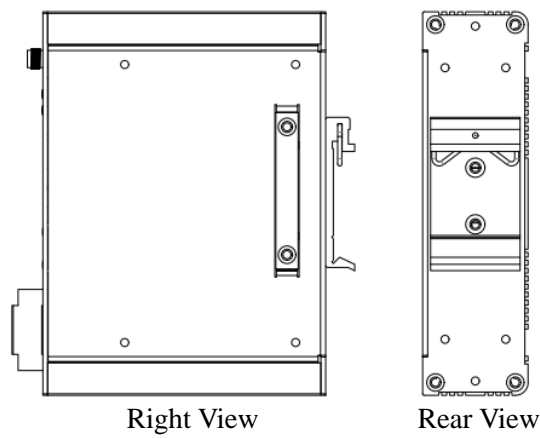

Figure 2-13. Right / Rear side dimension of the WF-2572M

### 3. Software

This chapter explains how to use the WF-2572 Utility to carry on the WF-2572 wireless communication configuration.

#### 3.1 Wireless Configuration Tool – WF-2572 Utility

WF-2572 utility is a Microsoft Windows application that compatibles with Microsoft Windows XP, 7 and 10.

The WF-2572 Utility can be downloaded from

<ftp://ftp.icpdas.com/pub/cd/usbcd/napdos/wifi/wf-2572/software/utility/>

#### 3.2 WF-2572 Utility

The main screen of WF-2572 utility has shown in Figure 3-1; Users can configure the wireless communication settings via this interface.

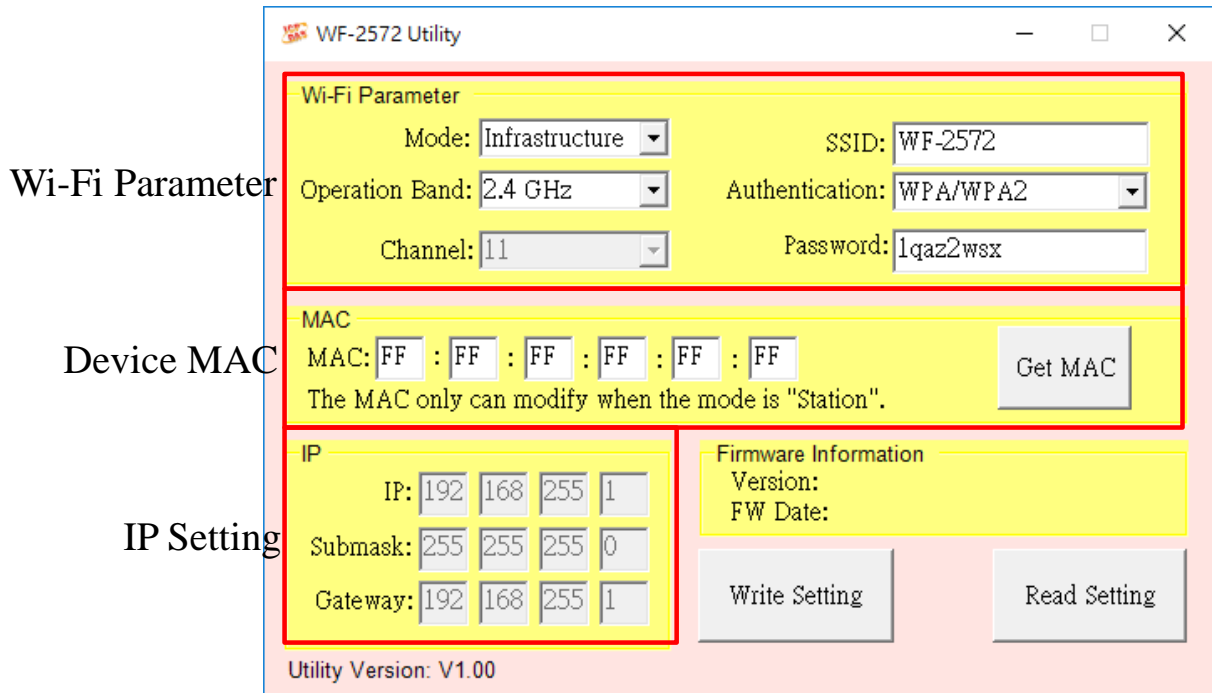

Figure 3-1. WF-2572 Utility



---

### 3.3.1 Wi-Fi Parameter

The Wi-Fi parameter can be divided into six types. The description of Wi-Fi parameter has shown in Table 3-1.

Table 3-1. Description of Wi-Fi Parameter

Wi-Fi Parameter	Description
Mode	The Wi-Fi role of WF-2572. The Wi-Fi role consists of Station (Infrastructure) and AP (Limit-AP).
SSID	Wi-Fi SSID 1. It can set the AP's SSID when the mode is "Limit-AP". 2. The SSID mean that the Wi-Fi AP which WF-2572 would like to connect when the mode is "Infrastructure". * Connected devices must be with the same SSID
Operation Band	The operation band of WF-2572. The WF-2572 supports 2.4/5 GHz.
Authentication	The encryption of WF-2572 Encryption of Wi-Fi, connected devices must with the same encryption.
Channel	Wi-Fi transmission channel setting CH 1~11: operation band is 2.4 GHz. CH 36/40/44/48: operationband is 5 GHz *The channel can change when the role is "Limit-AP".
Password	Key of Encryption , connected devices must with the same password. *The length of password is 8~63 characters.

### 3.3.2 Device MAC

The device MAC must be setting when device is in the "Infrastructure" mode. If user didn't know device's MAC address, the utility can use for searching device MAC. The user can use the "Get MAC" button for searching device mac. The following step show that how to get device MAC from utility.

**Step1.** Please connect the Ethernet cable between PC and device.

**Step2.** Please fill in the IP address of the device.

**Step3.** The utility will display the device MAC address after clicking "Get MAC" button.

**Step4.** The utility will appear a successful message when the utility get the MAC from the device.

**Note: The PC and device must be in the same IP segment.**

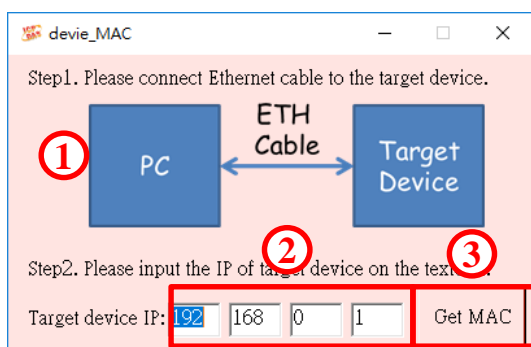

Figure 3-2. device MAC search

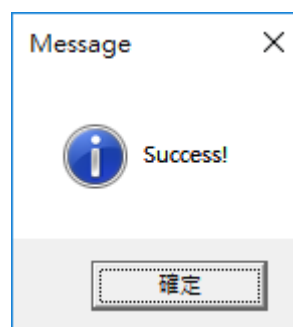

Figure 3-3 Success message

### 3.3.3 IP Setting

The IP setting only support with the “Limit-AP” mode.

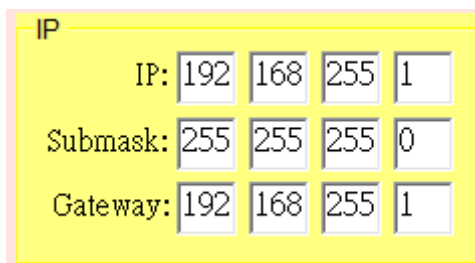

Figure 3-4. Device IP Setting

## 4. Application Setting

Users can use two WF-2572s or one WF-2572 module with the computer that supports wireless network connection structure in the application.

The WF-2572 supports two Wi-Fi roles for suffice the purpose. One is Limit-AP mode. The other is Infrastructure mode. The chapter 4 will explain the Wi-Fi setting and application architecture in the “Limit-AP” and “Infrastructure” mode.

### 4.1 System Architecture of Infrastructure Mode

The system architecture of infrastructure mode shows in Figure 4-1. WF-2572 can connect one device by the Ethernet interface. The WF-2572 will convert the Ethernet to Wi-Fi interface. The WF-2572 will connect to the Wi-Fi AP at the infrastructure mode. The Wi-Fi AP can be

WF-2572 or other APs. The device can access Wi-Fi network after connecting to Wi-Fi AP.

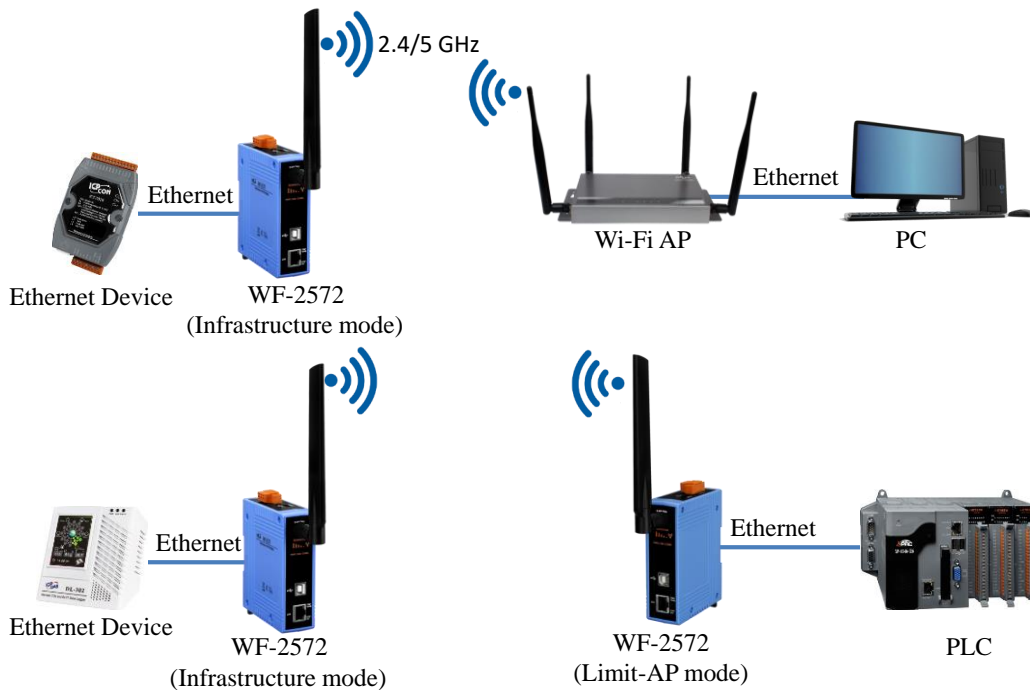

Figure 4-1. System Architecture on Infrastructure Mode

## 4.2 System Architecture of Limit-AP Mode

The system architecture of infrastructure mode shows in Figure 4-2. The WF-2572 has only one LAN port. But it can use the Ethernet switch to extend LAN port. The WF-2572 can connect by other Wi-Fi stations in the “Limit-AP” mode. The Wi-Fi can be WF-2572 or other Wi-Fi devices.

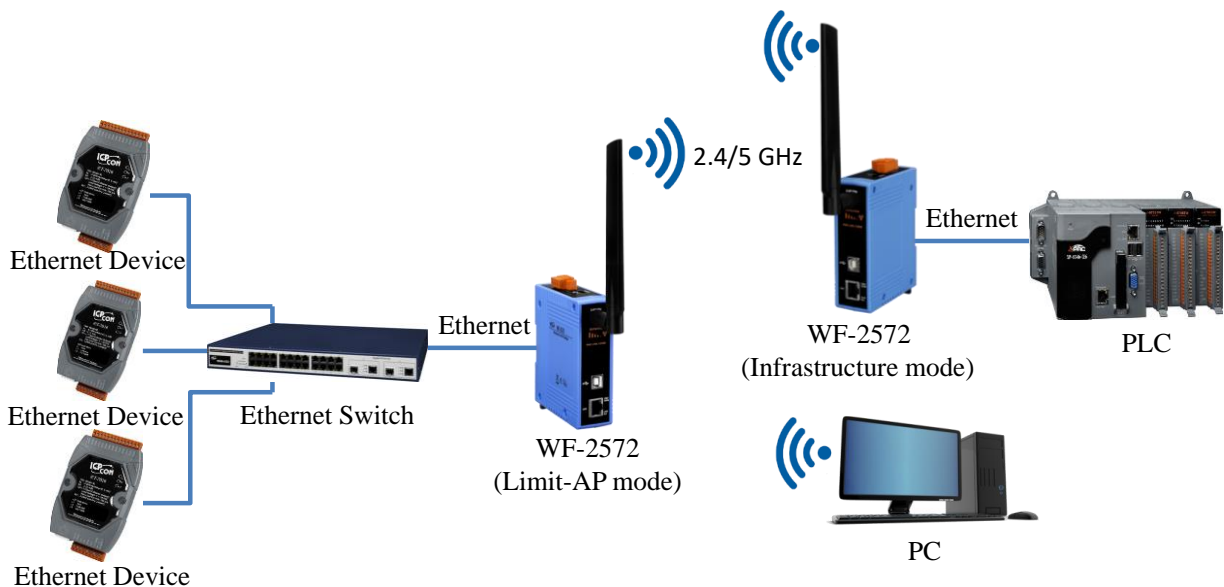

Figure 4-2. System Architecture on Limit-AP Mode

### 4.3 Hardware Installation

The associated hardware configuration is shown as following steps.

#### Step1. Checking the WF-2572 operation mode

It needs to set the DIP switch to the "OP" position (operating mode). As resetting the power, it will cause the device to operate in the operation mode.

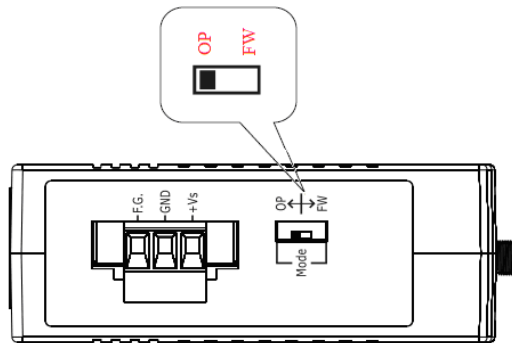

Figure 4-3 "OP" Position

#### Step2. Power connection

As shown in Figure 2-4, it needs to connect the power supply to power terminator of WF-2572.

#### Step3. USB port connection

WF-2572 supports USB communication for wireless configuration. If it does not need to modify the parameter settings, this step can be omitted.

### 4.4 Infrastructure Setting Description

#### 4.4.1 Test Architecture

The test architecture shows in Figure 4-4. The WF-2572 connects to the PC by Ethernet interface. The Wi-Fi AP connects to other PC by Ethernet interface. The WF-2572 set to "Infrastructure" mode that it connects to the Wi-Fi AP.

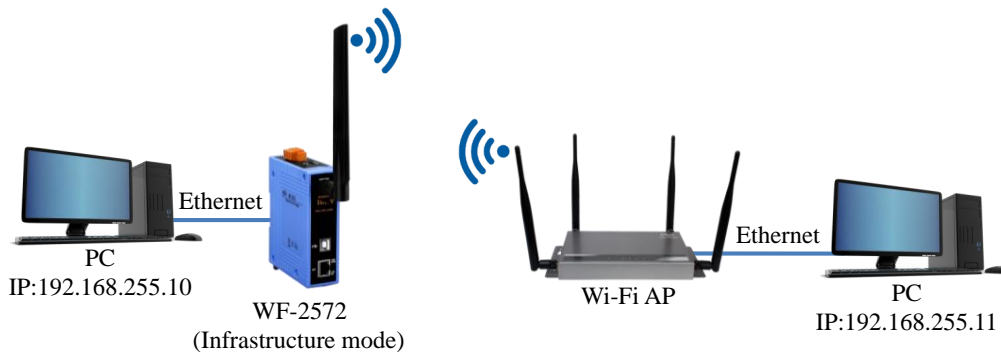

Figure 4-4. Test Architecture of Infrastructure

#### 4.4.2 Setting step

The WF-2572 has three steps. The setting step shows as following:

##### Step1. Set WF-2572 to “Infrastructure” mode and Wi-Fi parameter

1. Change “Mode” to “Infrastructure”
2. Set AP SSID
3. Set authentication of Wi-Fi
4. Set password of Wi-Fi
5. Set device MAC. If you didn’t know the device’s MAC, you can refer to chapter 3.3.2.
6. Click “Write Setting” to save setting

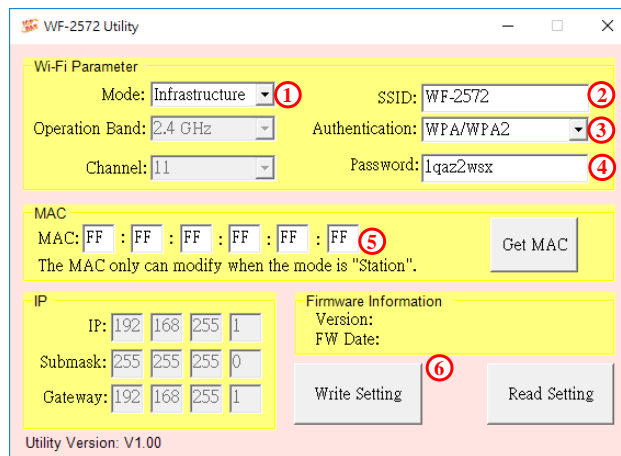

Figure 4-5. Infrastructure setting step

##### Step2. Set Computer’s IP

1. Please set the computer’s IP to 192.168.255.10 and 192.168.255.11.

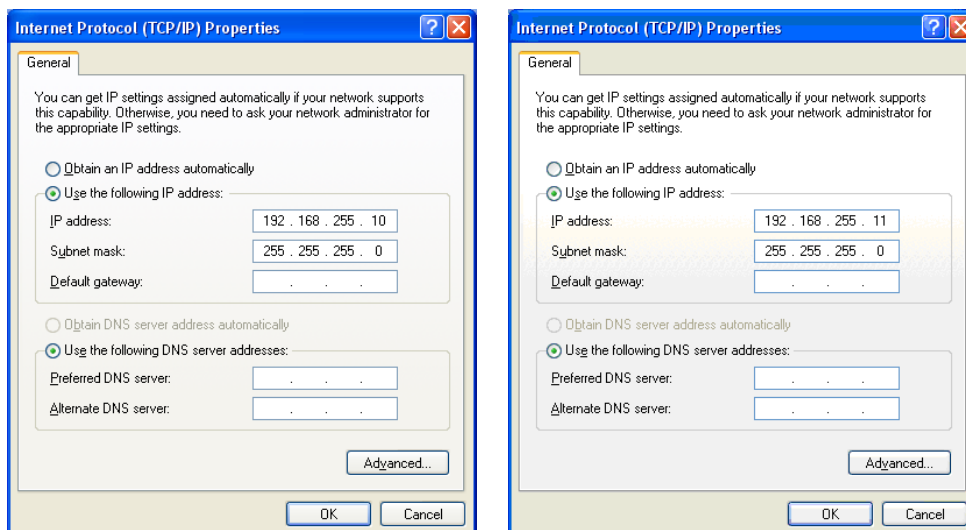

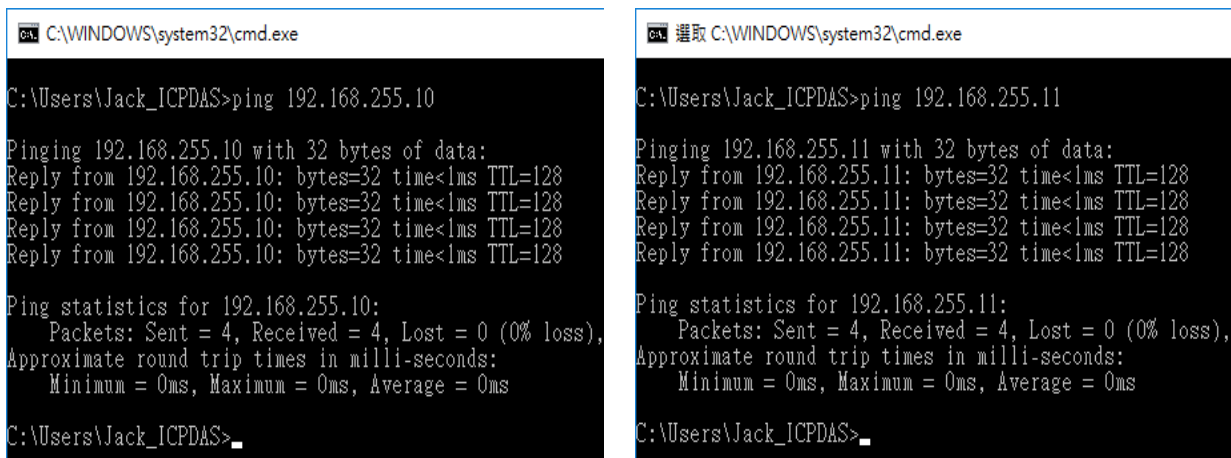

Figure 4-6. set computer IP

---

### Step3. Internet connection test

1. The Windows(  ) + R will show you the “RUN” box where you can type commands to either pull up a program. The command line windows will be opening after typing “cmd” at the “RUN” box.
2. Please execute following command on the command line window.  
Command 1: ping 192.168.255.10  
Command 2: ping 192.168.255.11
3. As shown in Figure 4-7, the internet access is working fine that it should show a similar reaction as following figures.



```
C:\WINDOWS\system32\cmd.exe
C:\Users\Jack_ICPDAS>ping 192.168.255.10
Pinging 192.168.255.10 with 32 bytes of data:
Reply from 192.168.255.10: bytes=32 time<1ms TTL=128
Reply from 192.168.255.10: bytes=32 time<1ms TTL=128
Reply from 192.168.255.10: bytes=32 time<1ms TTL=128
Reply from 192.168.255.10: bytes=32 time<1ms TTL=128
Ping statistics for 192.168.255.10:
    Packets: Sent = 4, Received = 4, Lost = 0 (0% loss),
    Approximate round trip times in milli-seconds:
        Minimum = 0ms, Maximum = 0ms, Average = 0ms
C:\Users\Jack_ICPDAS>

C:\WINDOWS\system32\cmd.exe
C:\Users\Jack_ICPDAS>ping 192.168.255.11
Pinging 192.168.255.11 with 32 bytes of data:
Reply from 192.168.255.11: bytes=32 time<1ms TTL=128
Reply from 192.168.255.11: bytes=32 time<1ms TTL=128
Reply from 192.168.255.11: bytes=32 time<1ms TTL=128
Reply from 192.168.255.11: bytes=32 time<1ms TTL=128
Ping statistics for 192.168.255.11:
    Packets: Sent = 4, Received = 4, Lost = 0 (0% loss),
    Approximate round trip times in milli-seconds:
        Minimum = 0ms, Maximum = 0ms, Average = 0ms
C:\Users\Jack_ICPDAS>
```

Figure 4-7. Ping Success

#### 4.4.3 Query device MAC by using WF-2572 utility

According to the type of device, it can be divided into different query methods. When the device is computer, it can use the command line windows to query the MAC address. If the device is PLC or other Ethernet devices, it can use the WF-2572 utility to query the MAC address.

1. Device: Computer

**Setp1.** The Windows(  ) + R will show you the “RUN” box where you can type commands to either pull up a program. The command line windows will be opening after typing “cmd” at the “RUN” box.

**Step2.** Please execute “ipconfig/all” command on the command line window. The computer’s MAC will show at the command line windows. The result has shown in Figure 4-8.

```

C:\WINDOWS\system32\cmd.exe
C:\Users\Jack_ICPDAS>ipconfig /all

Windows IP Configuration

Host Name . . . . . : DESKTOP-L641TGT
Primary Dns Suffix . . . . . :
Node Type . . . . . : Hybrid
IP Routing Enabled. . . . . : No
WINS Proxy Enabled. . . . . : No

Ethernet adapter 乙太網路:

Connection-specific DNS Suffix  . :
Description . . . . . : Realtek PCIe GBE Family Controller
Physical Address. . . . . : 40-8D-5C-1C-DE-8C
Dhcp Enabled. . . . . : No
Autoconfiguration Enabled . . . . : Yes

```

Figure 4-8. Computer's MAC

2. Device: PLC or other Ethernet devices

**Step1.** Connect the Ethernet cable between computer and PLC

It needs to remove the Ethernet cable between device (PLC or other Ethernet devices) and WF-2572. After that, you can connect the Ethernet to the computer.

**Step2.** Execute WF-2572 utility

1. Click the “Get MAC” button after executing the WF-2572 utility.
2. Please fill in the IP address of the device (PLC or other Ethernet devices).
3. Click the “Get MAC” button.

**Note: That the device and computer must be on the same network segment.**

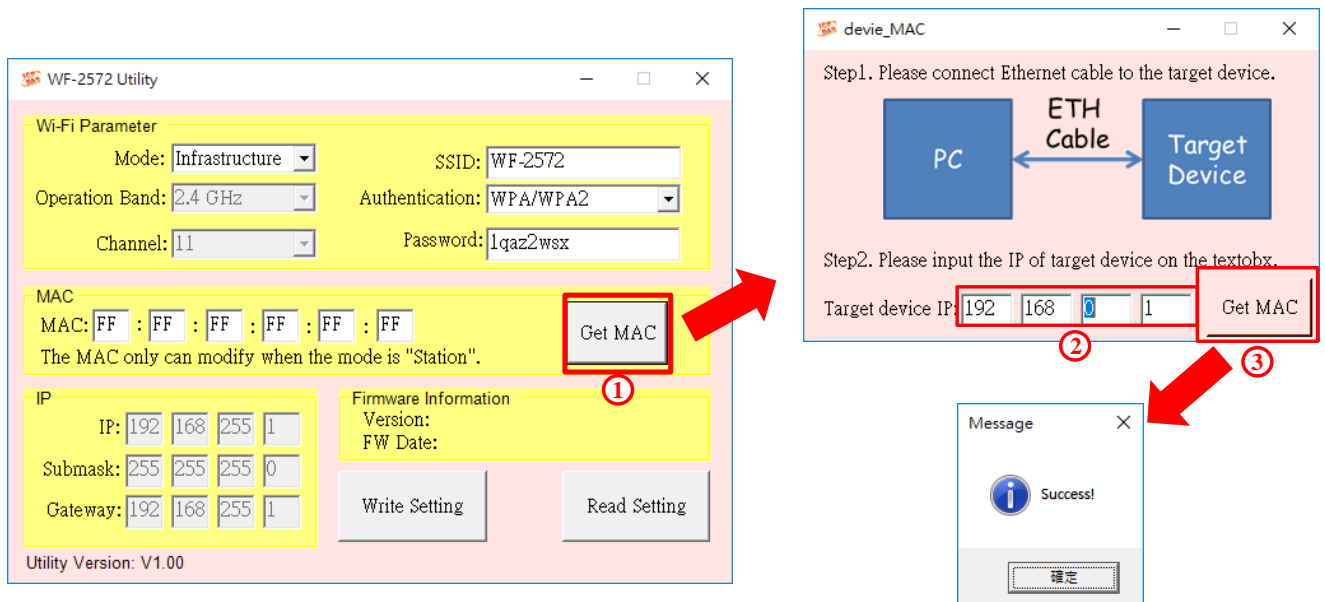

Figure 4-9. Query IP form PLC or other Ethernet devices

---

## 4.5 Limit-AP Mode

### 4.5.1 Test Architecture

The test architecture has shown in Figure 4-10. Both of WF-2572 connects to the computer by Ethernet. One of the WF-2572 sets to the Limit-AP mode. The other WF-2572 sets to the Infrastructure mode.

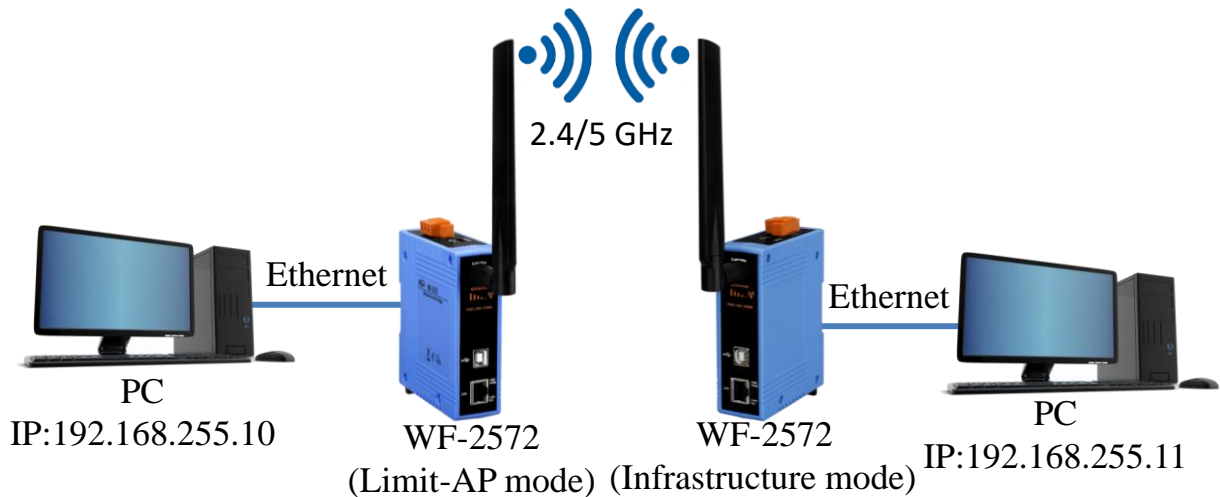

Figure 4-10. Limit-AP of Test Architecture

### 4.5.2 Setting step

As shown in following step, the WF-2572 has four setting steps on the Limit-AP mode.

#### **Step1.** WF-2572 Limit-AP parameter setting

1. Please change the mode to the “Limit-AP” ◦
2. Please select the operation band of WF-2572.
3. Please select the AP’s Wi-Fi channel.
4. Please set the AP’s SSID.
5. Please set the AP’s authentication.
6. Please set password of AP.
7. Please set IP/Submask/Gateway of WF-2572
8. Please click the “Write Setting” button to save the setting.



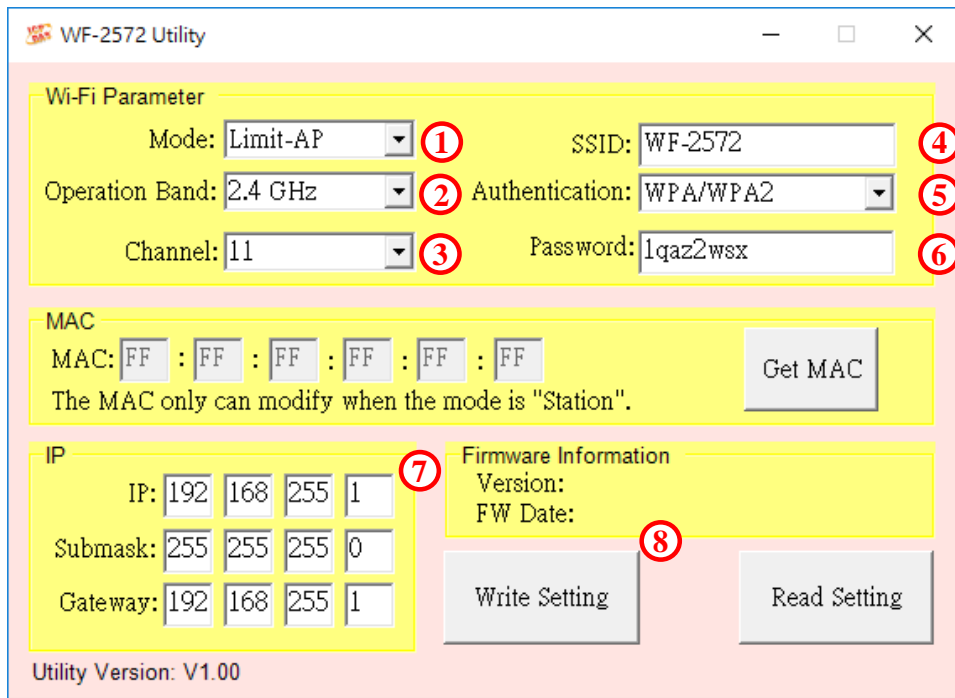

Figure 4-11. Setting Wi-Fi Parameter

**Step2.** The WF-2572’s Infrastructure setting can refer to chapter 4.4.

**Step3.** Setting PC’s IP

1. As shown in Figure 4-12, the PC’s is “192.168.255.10” and “192.168.255.11”.

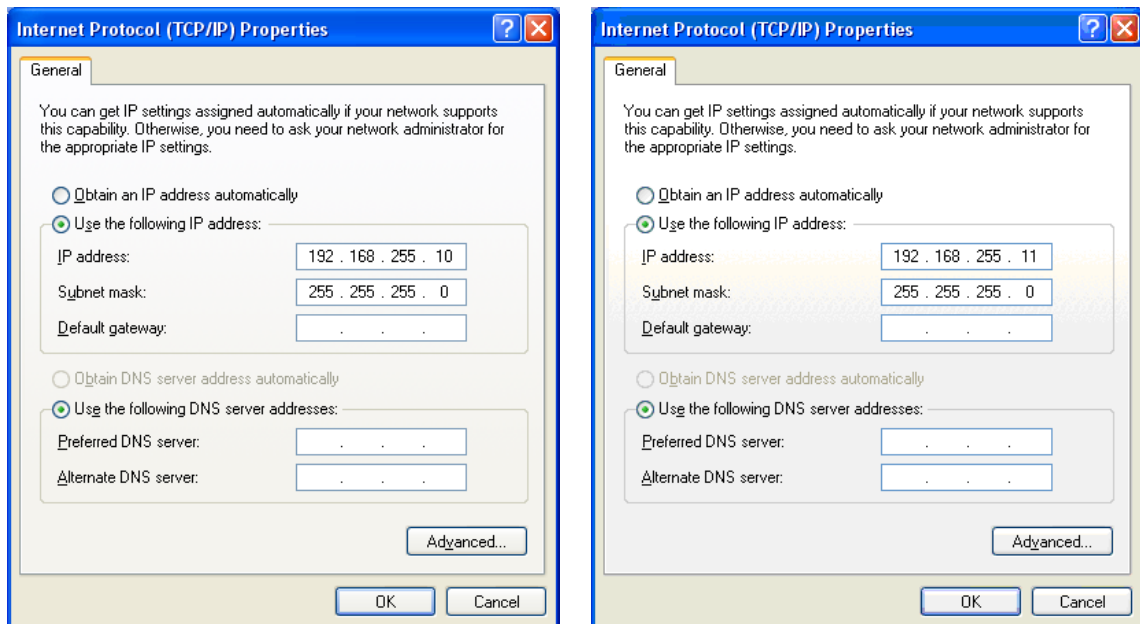

Figure 4-12. Setting PC’s IP

**Step4.** Internet Connection

1. The Windows (Windows logo) + R will show you the “RUN” box where you can type commands to either pull up a program. The command line windows will be opening after typing “cmd” at the “RUN” box.

- 
2. Please execute following command on the command line window.

Command 1: ping 192.168.255.10

Command 2: ping 192.168.255.11

3. As shown in Figure 4-13, the internet access is working fine that it should show a similar reaction as following figures.

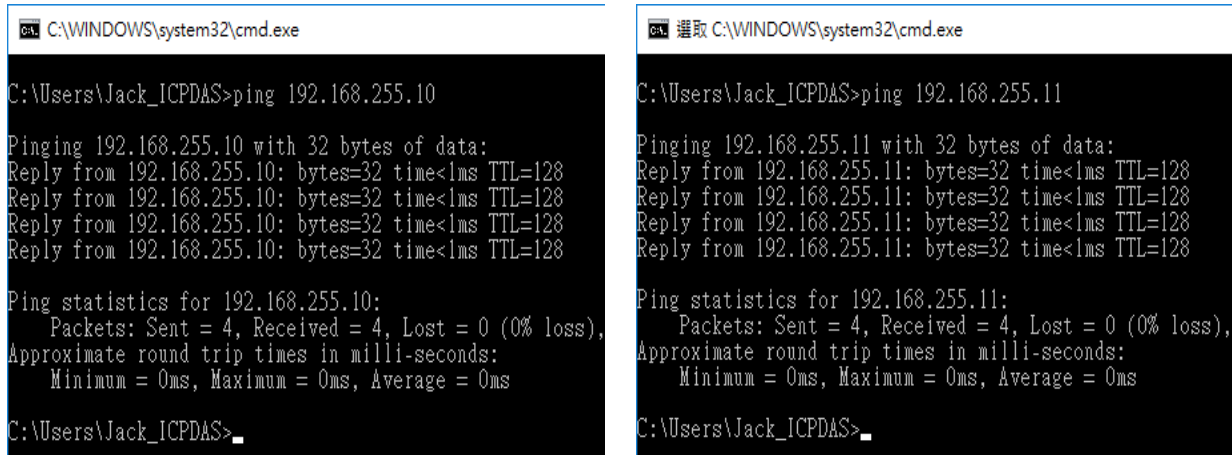

```
C:\WINDOWS\system32\cmd.exe
C:\Users\Jack_ICPDAS>ping 192.168.255.10

Pinging 192.168.255.10 with 32 bytes of data:
Reply from 192.168.255.10: bytes=32 time<1ms TTL=128
Reply from 192.168.255.10: bytes=32 time<1ms TTL=128
Reply from 192.168.255.10: bytes=32 time<1ms TTL=128
Reply from 192.168.255.10: bytes=32 time<1ms TTL=128

Ping statistics for 192.168.255.10:
    Packets: Sent = 4, Received = 4, Lost = 0 (0% loss),
    Approximate round trip times in milli-seconds:
        Minimum = 0ms, Maximum = 0ms, Average = 0ms

C:\Users\Jack_ICPDAS>

C:\WINDOWS\system32\cmd.exe
C:\Users\Jack_ICPDAS>ping 192.168.255.11

Pinging 192.168.255.11 with 32 bytes of data:
Reply from 192.168.255.11: bytes=32 time<1ms TTL=128
Reply from 192.168.255.11: bytes=32 time<1ms TTL=128
Reply from 192.168.255.11: bytes=32 time<1ms TTL=128
Reply from 192.168.255.11: bytes=32 time<1ms TTL=128

Ping statistics for 192.168.255.11:
    Packets: Sent = 4, Received = 4, Lost = 0 (0% loss),
    Approximate round trip times in milli-seconds:
        Minimum = 0ms, Maximum = 0ms, Average = 0ms

C:\Users\Jack_ICPDAS>
```

Figure 4-13. Ping Success

## 5. Technical Support

Please contact us if you have any questions about products.

ICP DAS website: <http://www.icpdas.com>

Email: [service@icpdas.com](mailto:service@icpdas.com)