

# WP-5231 (WinCE7 Based) Series

## User Manual

Version 1.0.0, January 2015

Service and usage information for

WP-5231

WP-5231M-3GWA



Written by Sean  
Edited by Anna Huang

## Warranty

---

All products manufactured by ICP DAS are under warranty regarding defective materials for a period of one year, beginning from the date of delivery to the original purchaser.

## Warning

---

ICP DAS assumes no liability for any damage resulting from the use of this product. ICP DAS reserves the right to change this manual at any time without notice. The information furnished by ICP DAS is believed to be accurate and reliable. However, no responsibility is assumed by ICP DAS for its use, not for any infringements of patents or other rights of third parties resulting from its use.

## Copyright

---

Copyright © 2015 by ICP DAS Co., Ltd. All rights are reserved.

## Trademark

---

The names used for identification only may be registered trademarks of their respective companies.

### Contact US

If you have any problem, please feel free to contact us.

You can count on us for quick response.

Email: [service@icpdas.com](mailto:service@icpdas.com)

# Contents

Contents .....	3
1. Introduction.....	6
1.1. Features .....	7
1.2. Specifications .....	10
1.3. Overview .....	12
1.4. Dimensions.....	17
1.5. Companion CD.....	18
2. Getting Started .....	19
2.1. Mounting the Hardware .....	20
2.2. Installing the XV-Board.....	22
2.3. Configuring the Boot Mode.....	23
2.4. Using PAC Utility to Manage WinPAC.....	25
2.5. Using DCON Utility Pro to Configure I/O Modules.....	26
2.6. Changing the User Interface Language.....	29
3. Tools and Tasks .....	31
3.1. PAC Utility .....	33
3.1.1. Menu Bar – File .....	34
3.1.2. Menu Bar – Help .....	35
3.1.3. Property Tab - General.....	36
3.1.4. Property Tab – Display .....	38
3.1.5. Property Tab – IP Config.....	39
3.1.6. Property Tab – Network .....	40
3.1.7. Property Tab – Device Information.....	43
3.1.8. Property Tab – Auto Execution.....	44
3.1.9. Property Tab – Rotary Execution .....	45
3.2. DCON Utility Pro .....	46
3.3. TaskMgr .....	47
3.4. VCEP.....	48
3.5. Remote_Display .....	49
3.6. SendToCOM .....	50
3.7. RegEdit.....	51
3.8. ISQLW35.....	52

3.9. INotepad.....	53
4. Your First WinPAC Program.....	54
4.1. Preparing the Development Tools.....	55
4.2. Installing WP-5231 SDK.....	56
4.3. First WinPAC Program in VB.NET.....	59
4.3.1. Create a New Project.....	60
4.3.2. Specify the Path of PAC Reference.....	63
4.3.3. Add the Control to the Form.....	66
4.3.4. Add the Event Handling for the Control.....	68
4.3.5. Upload the Application to WinPAC.....	70
4.3.6. Execute the Application on WinPAC.....	72
4.4. First WinPAC Program in Visual C#.....	73
4.4.1. Create a New Project.....	74
4.4.2. Specify the Path of PAC Reference.....	77
4.4.3. Add the Control to the Form.....	80
4.4.4. Add the Event Handling for the Control.....	82
4.4.5. Upload the Application to WinPAC.....	84
4.4.6. Execute the Application on WinPAC.....	86
4.5. First WinPAC Program in Visual C++.....	87
4.5.1. Create a New Project.....	88
4.5.2. Configure the Platform.....	93
4.5.3. Specify the Path of the PAC Reference.....	94
4.5.4. Add the Control to the Form.....	97
4.5.5. Add the Event Handling for the Control.....	100
5. APIs and Samples.....	105
5.1. PAC Standard APIs.....	106
5.1.1. VB.NET Samples for PAC Standard APIs.....	107
5.1.2. C# Samples for PAC Standard APIs.....	108
5.1.3. Visual C++ Samples for PAC Standard APIs.....	109
5.2. PAC IO APIs.....	110
5.2.1. VB.NET Samples for PAC Standard APIs.....	111
5.2.2. C# Samples for PAC Standard APIs.....	112
5.2.3. Visual C++ Samples for PAC Standard APIs.....	113
6. I/O Modules and SDK Selection.....	114
7. WP-5231 Updates.....	117
7.1. OS Updates.....	118

7.1.1. OS Updates using Eshell .....	119
7.1.2. OS Updates using micro_SD.....	122
7.2. SDK Updates.....	124
7.2.1. SDK Updates for VB.NET or C#.....	125
7.2.2. SDK Updates for Visual C++ .....	126
A. Tips – How to .....	127
A.1. How to use the Printer.....	127
A.1.1. How to use the network printer .....	128
A.1.2. How to use the USB printer .....	130
A.2. How to Automatically Synchronize WinPAC Clock with an Internet Time Server .....	131
A.3. How to use User Account Control in WinPAC.....	133
A.3.1. How to Create an User Account.....	133
A.3.2. How to Use Telnet to remote login the WinPAC from PC .....	135
A.3.3. How to Remove a User Account from the Login List.....	137
B. XV-Board Modules .....	138
C. Revision History .....	139

# 1. Introduction

This chapter provides an overview of the WP-5231 series modules and its components, and introduces the fundamental concepts for user familiar with the WP-5231 series modules.



The WP-5231 series is equipped an AM3352 CPU (720 MHz) and running a Windows Embedded Compact 7.0 operating system. Instead of external wireless module, the WP-5231 can add an internal 3G wireless module provides high-protection I/O. Using the built-in micro SD, the WP-5231 series can save application program, image file and data., various connectivity (VGA, USB, Ethernet, RS-232/485) and I/O expansion bus.

## 1.1. Features

The WP-5231 series modules offer the most comprehensive configuration and remote system upgrade solutions to meet specific application requirements. The following list shows the hardware and software features designed to simplify installation, configuration and application.

➤ **Windows Embedded Compact 7.0**



- Support PC based software: Visual Studio.NET
- Web server, FTP server, Telnet server

➤ **Local I/O and Communication Expansion Board**

WP-5231 series equip an I/O expansion bus to support one optional expansion board, called XV-board. It can be used to implement various I/O functions such as DI, DO, A/D, D/A, Timer/Counter



➤ **Various Memory Expansions**

WP-5231 series modules provides various memory storage options, such as FRAM and microSD. Customers can choose the memory based on their characteristics.



- 64 KB FRAM: no limit on the number of write-erase cycles.
- microSD/microSDHC: to implement portable data logging applications; supports up to 32 GB.

➤ **Unique 64-bit Hardware Serial Number to Protect Your Program**

A unique 64-bit serial number is assigned to each hardware device to protect your software against piracy.



➤ **Remote I/O Module and Expansion Unit**

With the built-in RS-485 and Ethernet port, the WP-5231 series modules can connect RS-485/Ethernet remote I/O units (RU-87Pn/ET-87Pn) or modules (I-7000/M-7000/ET-7000).

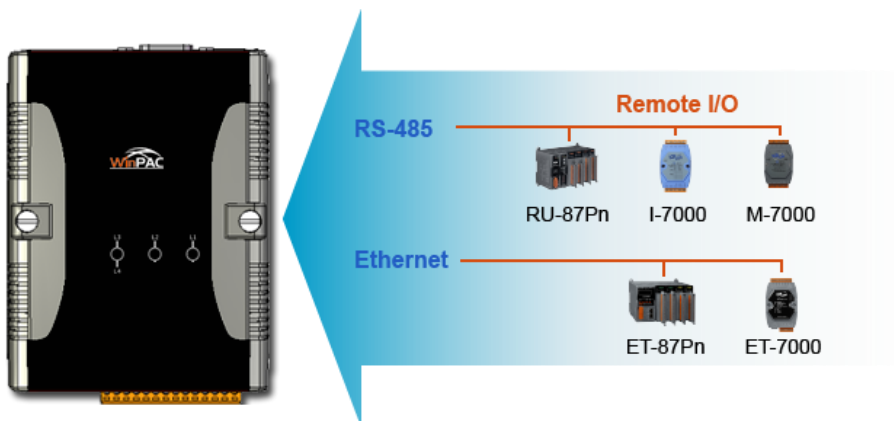



➤ **Plastic and Metal Housing**

The default case is plastic material. Metal casing is also offered to provide extra security.

➤ **Small and Easy Installation**

The WP-5231 series modules have a slender shape (91 mm x 132 mm x 52 mm) to be installing in a narrow space with DIN-Rail.



➤ **Highly Reliable Under Harsh Environment**

Our WinPACs operate in a wide range of temperature and humidity.

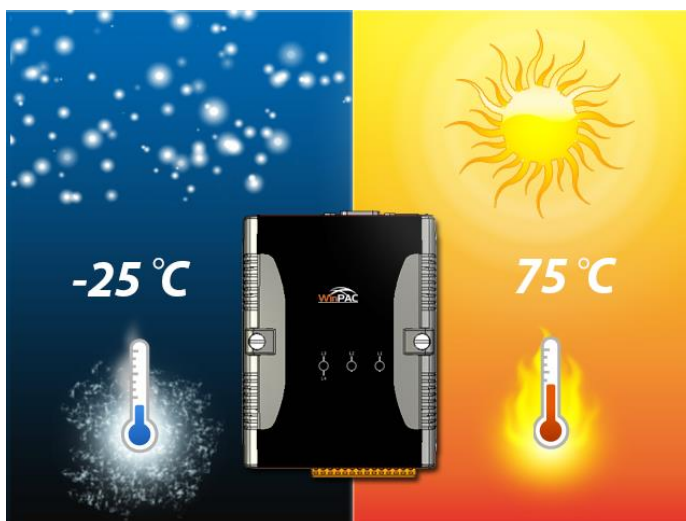

- Operating Temperature: -25 ~ +75 °C
- Storage Temperature: -40 ~ +80 °C
- Humidity: 10% ~ 90% RH, non-condensing

## 1.2. Specifications

The table below summarizes the specifications of the WP-5231 series modules.

Models	WP-5231	WP-5231M-3GWA
<b>System Software</b>		
OS	Windows CE 7.0 Professional	
Framework Support	.Net Compact Framework 3.5	
Embedded Service	FTP Server, Web Server	
SDK Provided	DII for Visual Studio.Net 2008	
Multilanguage Support	English, German, French, Spanish, Russian, Italian, Korean, Simplified Chinese, Traditional Chinese	
<b>CPU Module</b>		
CPU	AM3352, 720 MHz	
DDR3 SDRAM	256 MB	
Flash	256 MB	
FRAM	64 KB	
Expansion Flash Memory	microSD socket with one 4 GB microSD card (support up to 32 GB microSDHC card)	
RTC (Real Time Clock)	Provide second, minute, hour, date, day of week, month, year	
64-bit Hardware Serial Number	Yes, for software copy protection	
Dual Watchdog Timers	Yes	
Rotary Switch	Yes (0 ~ 9)	
LED Indicators	1 LED for Power and Running; 2 LEDs for user defined	
<b>VGA &amp; Communication Ports</b>		
Resolution	640 x 480, 800 x 480, 800 x 600, 1024 x 768	
Ethernet	RJ-45 x 1, 10/100/1000 Base-TX (Auto-negotiating, Auto MDI/MDI-X, LED indicators)	
USB 2.0	1	
COM 1	RS-232 (RxD, TxD, and GND); Non-isolated	
COM 2	RS-232 (RxD, TxD, and GND); Non-isolated	
COM 3	RS-485 (Data+, Data-); Non-isolated	

COM 4	RS-485 (Data+, Data-); 2500 V <sub>DC</sub> isolated	
<b>Wireless Port</b>		
Wireless Port	-	3G (WCDMA)
<b>I/O Expansion</b>		
I/O Expansion Bus	Yes, one optional XV-board	
<b>Mechanical</b>		
Dimensions (W x H x D)	91 mm x 132 mm x 52 mm	117 mm x 126 mm x 62 mm
Housing	Plastic	Metal
Installation	DIN-rail mounting	Wall mounting
<b>Environmental</b>		
Operating Temperature	-25 °C ~ +75 °C	
Storage Temperature	-30 °C ~ + 80 °C	
Ambient Relative Humidity	10 % ~ 90 % RH (non-condensing)	
<b>Power</b>		
Input Range	+12 V <sub>DC</sub> ~ +48 V <sub>DC</sub>	
Isolation	-	
Consumption	4.8W (0.2 A @ 24 V <sub>DC</sub> )	
<b>Modem Specification of WP-5231M-3GWA</b>		
<b>3G (WCDMA)</b>		
Band	UMTS: 2100/1900/850 MHz	
Data Transfer	UMTS/HSDPA/HSUPA Upload: Max. 5.76 Mbps Download: Max. 7.2 Mbps	
<b>2G (GPRS)</b>		
Band	850/900/1800/1900 MHz	
GPRS Multi-slot	Class 10/8	
GPRS Mobile Station	Class B	
GPRS Class 10	Max. 85.6 kbps	
CSD	Up to 14.4 kbps	
Compliant to GSM phase 2/2+	Class 4 (2 W @ 850/900 MHz); Class 1(1W @ 1800/1900 MHz)	
Coding Schemes	CS 1, CS 2, CS 3, CS 4	
SMS	Text and PDU mode	

## 1.3. Overview

The WP-5231 Series modules are equipped with several interfaces and peripherals that can be integrated with external systems. Here is an overview of the components and its descriptions. The details of these items are as follows:

### Front View

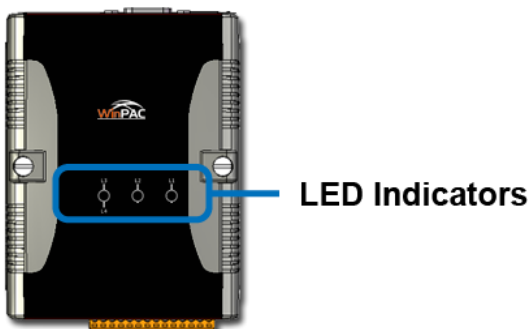

Item	Description								
LED Indicators	<p>The WP-5231 series modules has one system LED indicators and two user programmable LED Indicators.</p> <div style="text-align: right;"> <p><b>User Programmable LED Indicators</b></p> </div> <p>A system LED indicator display the status of the WP-5231 series modules. The details are shown as below.</p> <table border="1"> <thead> <tr> <th>LED Indicator</th> <th>Color (On state)</th> <th>Meaning</th> </tr> </thead> <tbody> <tr> <td rowspan="2">RUN/PWR</td> <td>Green</td> <td>Power is on</td> </tr> <tr> <td>Orange</td> <td>Power on and OS is running</td> </tr> </tbody> </table>	LED Indicator	Color (On state)	Meaning	RUN/PWR	Green	Power is on	Orange	Power on and OS is running
LED Indicator	Color (On state)	Meaning							
RUN/PWR	Green	Power is on							
	Orange	Power on and OS is running							

## Top View

---

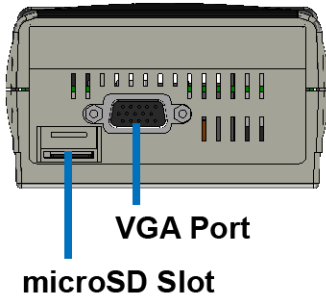

Item	Description
microSD Slot	The microSD slot can be used to restore the WinPAC system and expand the memory up to 32 GB.
VGA port	A VGA connector is a 3-row 15-pin connector that can be used with a variety of supported VGA resolutions, and the output resolution covers 640x480, 800x480, 800x600, 1024x768.

## Bottom View

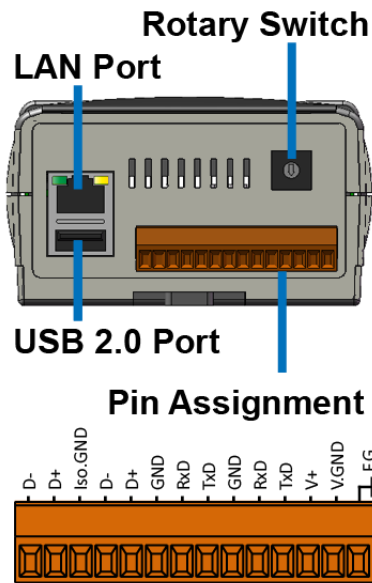

Item	Description
Rotary Switch	Rotary Switch is an operating mode selector switch which provides seven functions related to the selection of the operating mode for WinPAC. 

Item	Description															
LAN Port	<p>The WP-5231 has an Ethernet port that can be connected to a computer or device via an Ethernet cable.</p> <p>The Link/Act and 100M/1G LED indicators display the status of the WP-5231 LAN series modules. The details are shown as below.</p> <table border="1"> <thead> <tr> <th>LED Indicator</th> <th>State (Color)</th> <th>Meaning</th> </tr> </thead> <tbody> <tr> <td rowspan="2">100M/1G</td> <td>ON (Orange)</td> <td>Network Speed: 1 G</td> </tr> <tr> <td>OFF</td> <td>Network Speed: 10/100 M</td> </tr> <tr> <td rowspan="3">Link/Act</td> <td>ON (Green)</td> <td>The Link is active</td> </tr> <tr> <td>OFF</td> <td>The Link is inactive</td> </tr> <tr> <td>Blinking(Green)</td> <td>Network activity</td> </tr> </tbody> </table> 	LED Indicator	State (Color)	Meaning	100M/1G	ON (Orange)	Network Speed: 1 G	OFF	Network Speed: 10/100 M	Link/Act	ON (Green)	The Link is active	OFF	The Link is inactive	Blinking(Green)	Network activity
LED Indicator	State (Color)	Meaning														
100M/1G	ON (Orange)	Network Speed: 1 G														
	OFF	Network Speed: 10/100 M														
Link/Act	ON (Green)	The Link is active														
	OFF	The Link is inactive														
	Blinking(Green)	Network activity														
USB 2.0 Port	The WinPAC has an USB ports that allow support for the USB devices such as mouse, keyboard or an external USB hard drive.															

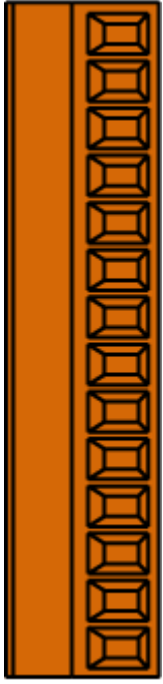
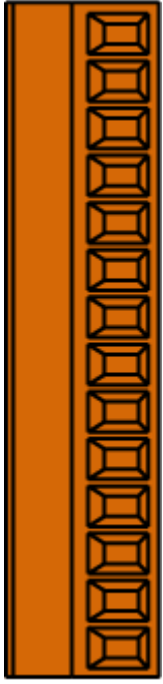
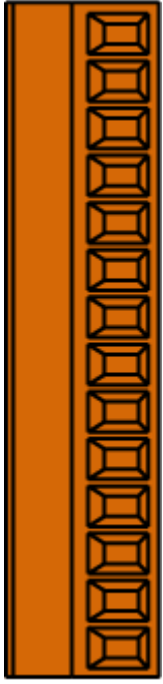
Item	Description																																																			
Pin Assignment	<p>The pin assignments of the connector are as follows:</p> <table border="1"> <thead> <tr> <th>Pin</th> <th>Signal</th> <th>Description</th> </tr> </thead> <tbody> <tr> <td></td> <td>1</td> <td>F.G</td> <td>Frame Ground</td> </tr> <tr> <td></td> <td>2</td> <td>P.GND</td> <td rowspan="2">Power Input</td> </tr> <tr> <td></td> <td>3</td> <td>PWR</td> </tr> <tr> <td></td> <td>4</td> <td>TXD</td> <td rowspan="3">COM 1: RS-232</td> </tr> <tr> <td></td> <td>5</td> <td>RXD</td> </tr> <tr> <td></td> <td>6</td> <td>GND</td> </tr> <tr> <td></td> <td>7</td> <td>TXD</td> <td rowspan="3">COM 2: RS-232</td> </tr> <tr> <td></td> <td>8</td> <td>RXD</td> </tr> <tr> <td></td> <td>9</td> <td>GND</td> </tr> <tr> <td></td> <td>10</td> <td>D+</td> <td rowspan="2">COM 3: RS-485</td> </tr> <tr> <td></td> <td>11</td> <td>D-</td> </tr> <tr> <td></td> <td>12</td> <td>ISO.GND</td> <td rowspan="3">COM 4: RS-485</td> </tr> <tr> <td></td> <td>13</td> <td>D+</td> </tr> <tr> <td></td> <td>14</td> <td>D-</td> </tr> </tbody> </table>	Pin	Signal	Description		1	F.G	Frame Ground		2	P.GND	Power Input		3	PWR		4	TXD	COM 1: RS-232		5	RXD		6	GND		7	TXD	COM 2: RS-232		8	RXD		9	GND		10	D+	COM 3: RS-485		11	D-		12	ISO.GND	COM 4: RS-485		13	D+		14	D-
Pin	Signal	Description																																																		
	1	F.G	Frame Ground																																																	
	2	P.GND	Power Input																																																	
	3	PWR																																																		
	4	TXD	COM 1: RS-232																																																	
	5	RXD																																																		
	6	GND																																																		
	7	TXD	COM 2: RS-232																																																	
	8	RXD																																																		
	9	GND																																																		
	10	D+	COM 3: RS-485																																																	
	11	D-																																																		
	12	ISO.GND	COM 4: RS-485																																																	
	13	D+																																																		
	14	D-																																																		

### COM1 (3-wire RS-232)

**Note:** 16C550 compatible

**Baud Rate:** 115200, 57600, 38400, 19200, 9600, 4800, 2400, 1200 bps

**Data Bits:** 5, 6, 7, 8

**Parity:** None, Even, Odd, Mark (Always 1), Space (Always 0)

**Stop Bits:** 1, 2

**FIFO:** 64 bytes

### COM2 (3-wire RS-232)

**Note:** 16C550 compatible

**Baud Rate:** 115200, 57600, 38400, 19200, 9600, 4800, 2400, 1200 bps

**Data Bits:** 5, 6, 7, 8

**Parity:** None, Even, Odd, Mark (Always 1), Space (Always 0)

**Stop Bits:** 1, 2

**FIFO:** 64 bytes

### COM3 (2-wire RS-485)

**Note:** 16C550 compatible

**Baud Rate:** 115200, 57600, 38400, 19200, 9600, 4800, 2400, 1200 bps

**Data Bits:** 5, 6, 7, 8

**Parity:** None, Even, Odd, Mark (Always 1), Space (Always 0)

**Stop Bits:** 1, 2

**FIFO:** 64 bytes

### COM4 (2-wire RS-485)

**Note:** 16C550 compatible

**Baud Rate:** 115200, 57600, 38400, 19200, 9600, 4800, 2400, 1200 bps

**Data Bits:** 5, 6, 7, 8

**Parity:** None, Even, Odd, Mark (Always 1), Space (Always 0)

**Stop Bits:** 1, 2

**FIFO:** 64 bytes





## 1.5. Companion CD

This package comes with a CD that provides a collection of the software utility, documentation, drivers, demo program and application. The CD contains several subdirectories located in \wp-5231 directory. All of them are listed below.

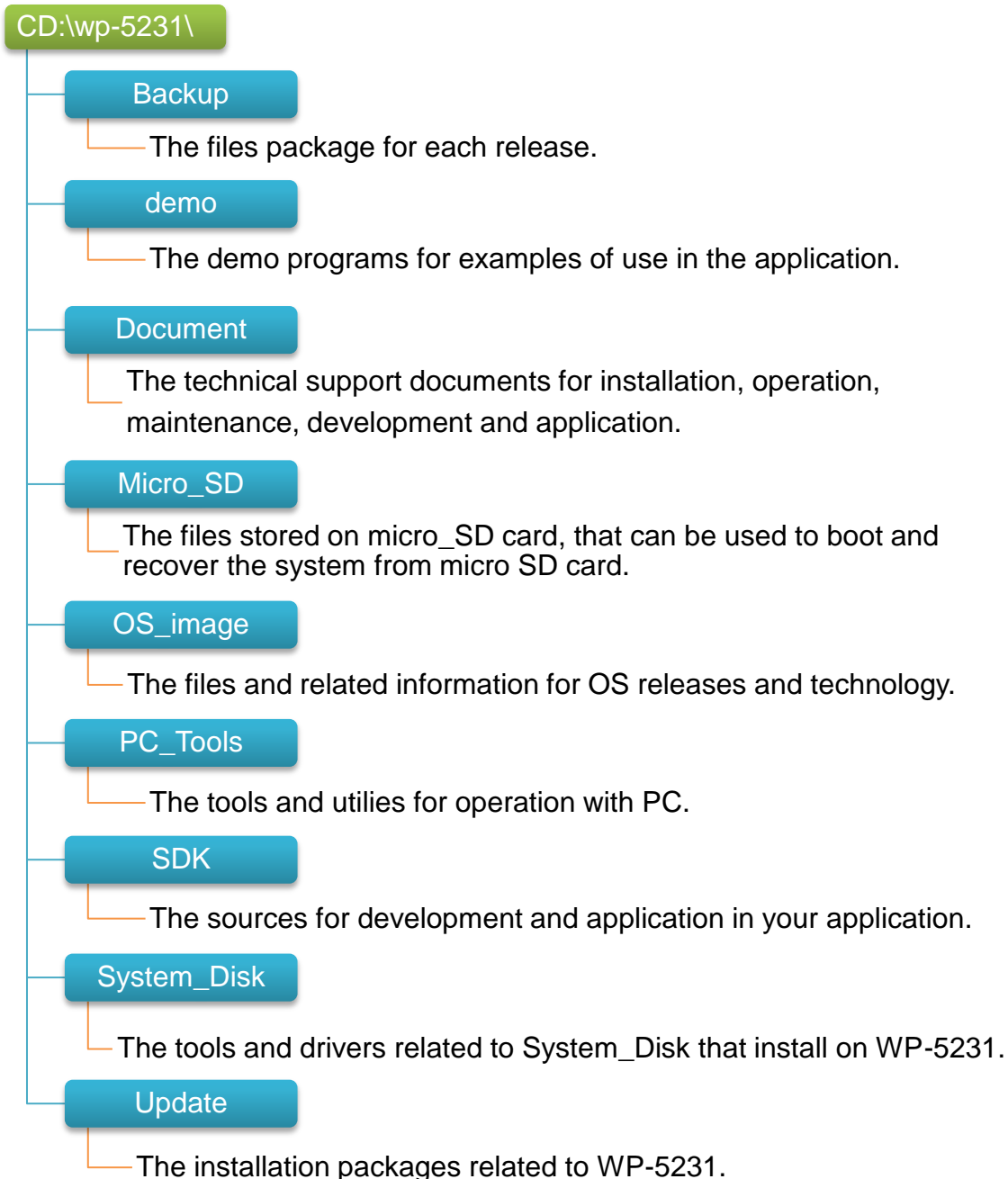

## 2. Getting Started

This chapter provides a guided tour of the WinPAC installation and configuration that describes the steps needed to download, install, configure, and run the basic procedures for user working with the WinPAC for the first time.

Before starting any task, please check the package contents. If any of the following package contents are missing or damaged, contact your dealer, distributor.



**WP-5231**



**A microSD card and a micro SD/SD adapter**



**Software Utility CD**



**Screw Driver**

(1C016)

2.4 mm



**GSM/GPRS Antenna**

**(ANT-421-02)**

**(for WP-5231M-3GWA series only)**

## 2.1. Mounting the Hardware

### Step 1: Mounting WP-5231

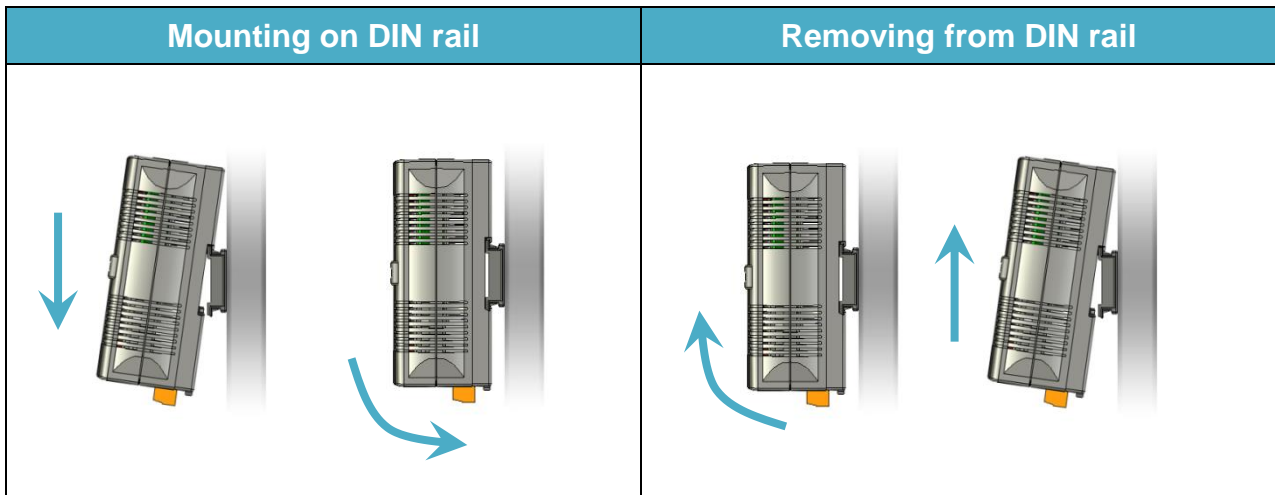

### DIN rail mounting

The WP-5231 has simple rail clips for mounting reliably on a standard 35 mm DIN rail.



## Step 2: Connecting to a PC, the USB device, and the power supply

- i. Connect the mouse or keyboard to the USB port.
- ii. Connect PC to the Ethernet port through an Ethernet switch.
- iii. Connect the power supply (+12 to +48 VDC) to PWR and P.GND terminals.
- iv. Connect the monitor to the VGA port.

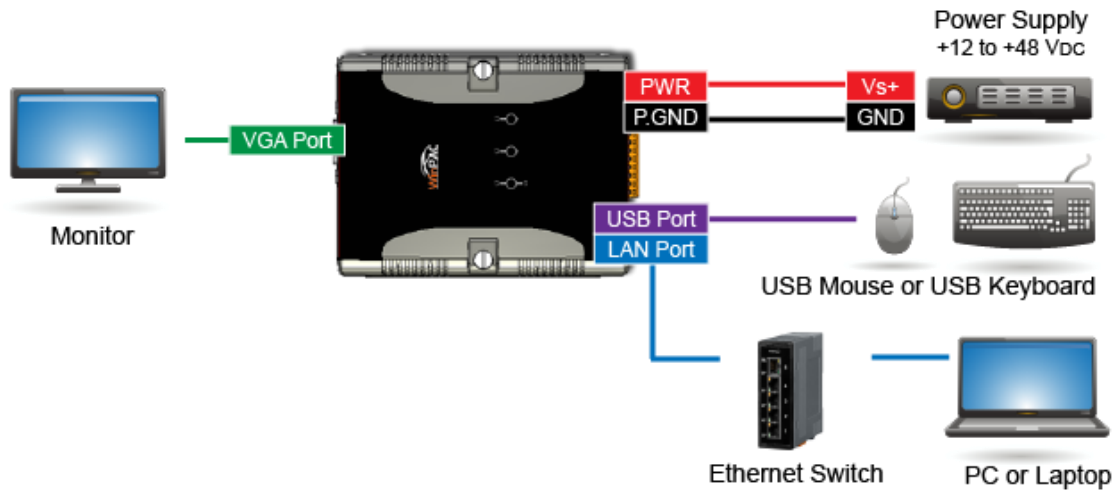



## 2.2. Installing the XV-Board

**What's in the package**

(A) Screws 

(B2) Connector 

(B1) XV-board 

(C) Pin assignment label 

for VPD-133/132, not for WP-5231 series

**(1)** 

**(2)** 

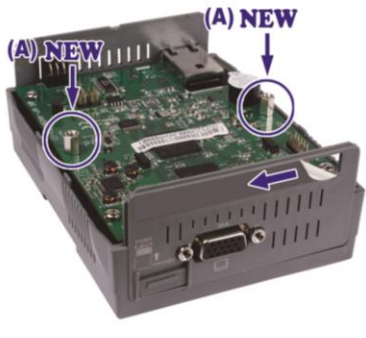
**(3)** 

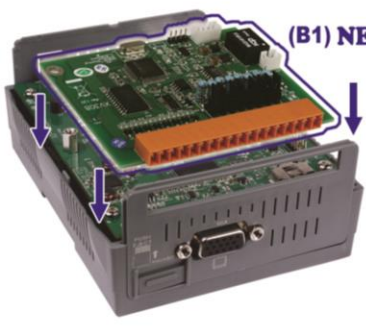
**(4)** 

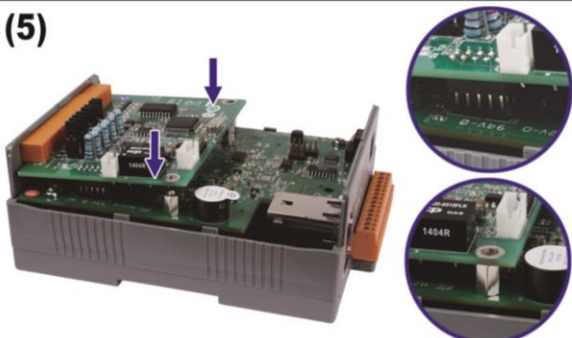
**(5)** 

**(6)** 

**(7)** 

**(8)** 

## 2.3. Configuring the Boot Mode

The WP-5231 has several operating modes, which can be selected by a rotary switch.

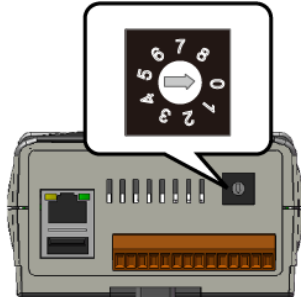

The table below lists the operation modes available with the WP-5231.

Position	Operating Mode
0	Normal mode (Default)
1	Safe mode
2	Debug mode
3	OS update mode by Ethernet
4	Reserve
5	OS update mode by Micro_SD
6	Reserve
7 ~ 9	Normal mode (For user)

The following is a brief introduction of these modes.

### Normal Mode (Default mode)

Normal mode is the default mode of operation and the one you will use most of the time. Use this mode for more tasks and configurations. Programs also are executed in this mode.

## **Safe Mode**

---

Safe mode is a trouble shooting. The mode loads the minimum required device drivers and system services to boot the WP-5231.

If you have malicious software or a program caused the WP-5231 cannot be boot or run the normal mode, you can boot in safe mode to solve the problem.

## **Debug Mode**

---

Debug mode is a special environment in which program debug functions can be used in addition to normal system functions.

Debug mode is unsupported.

## **OS Update Mode**

---

OS update mode is a way used to update OS. For more information on updating the WP-5231 OS image, please refer to section 6.1. OS updates

## **Reserve->OS Development Mode**

---

The positions 4, 6, of rotary switch are reserved for OS development.

## **User Mode**

---

The positions 7, 8, 9 of rotary switch are reserved for user's applications.

When WP-5231 is boot with one of these positions, it is boot at normal mode. User's application can check the position of the rotary switch position to run at different mode.



## 2.4. Using PAC Utility to Manage WinPAC

The PAC Utility is a collection of the WinPAC system tool that allows user quickly and easily manage and configure the WinPAC.

For more detailed information on PAC Utility applications, please refer to “3.1. PAC Utility”

### Step 1: Double-click the PAC Utility on the desktop

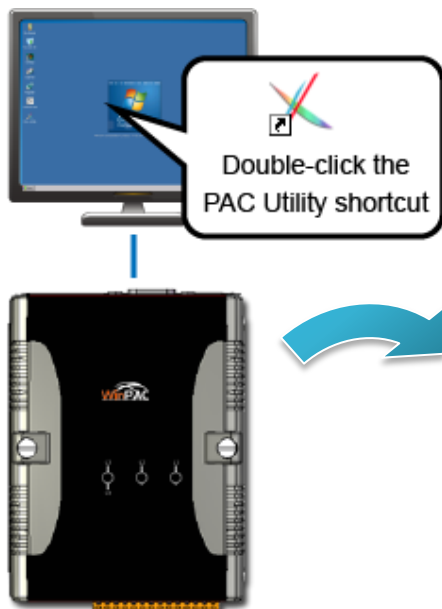

### Step 2: Configure IP address (DHCP), FTP Server, Auto Execution files..., etc

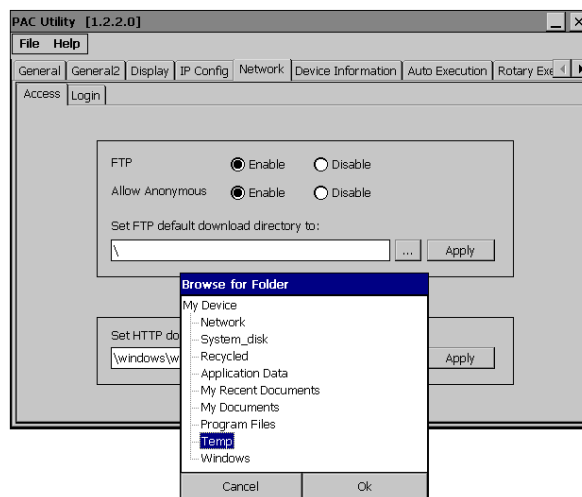

### Step 3: Reboot the WinPAC

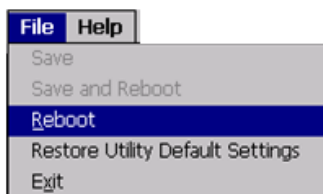

## 2.5. Using DCON Utility Pro to Configure I/O Modules

DCON Utility Pro enables users easily to configure and manage the I/O modules via Ethernet or serial ports (RS-232/RS-485).

**Step 1: Double-click the DCON\_Utility\_Pro on the desktop**

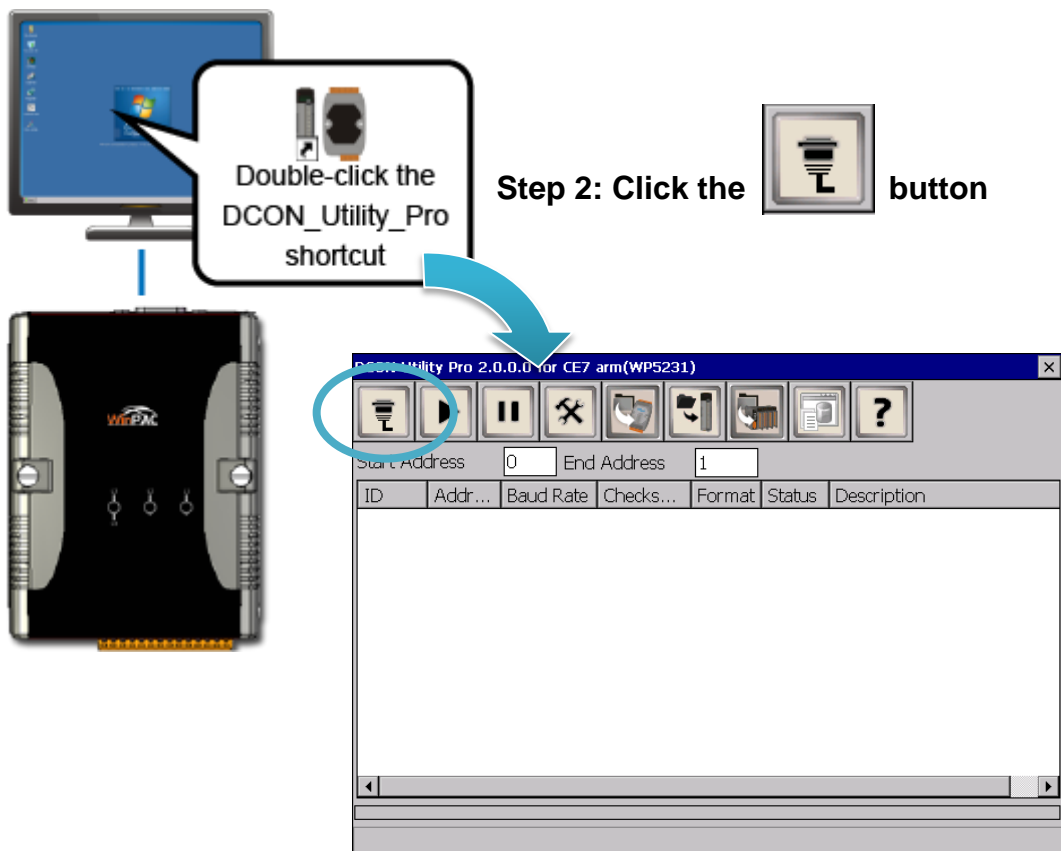

### Step 3: Configure the communication settings

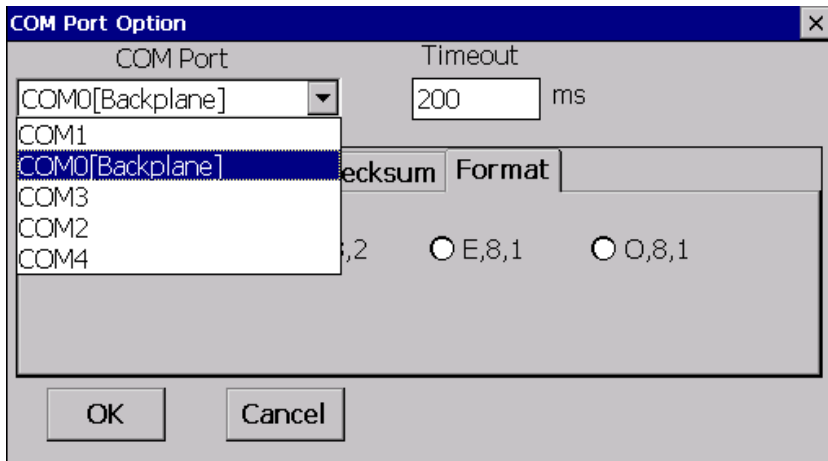

### Tips & Warnings



The COM port settings for expansion I/O modules are listed below.

**COM0[Backplane]** ←



**COM1/2/3/4** ←

For more information on these COM port selections, please refer to the specification of the pin assignments in section 1.3. Overview

Step 4: Click the  button

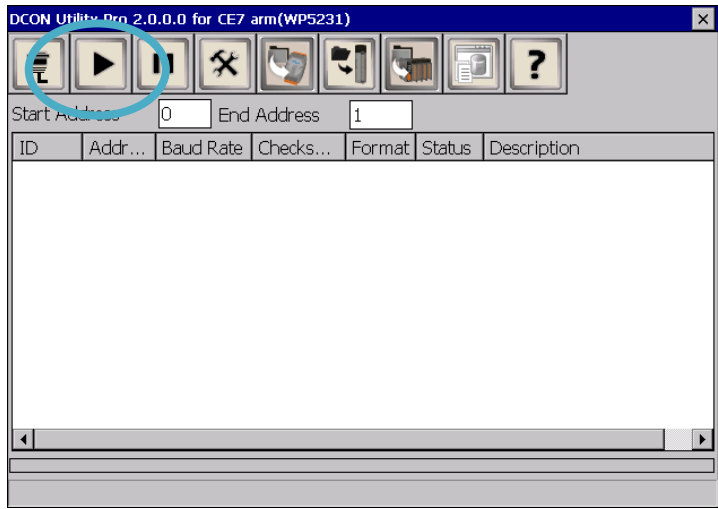

Step 5: Click the module name to configure the I/O module

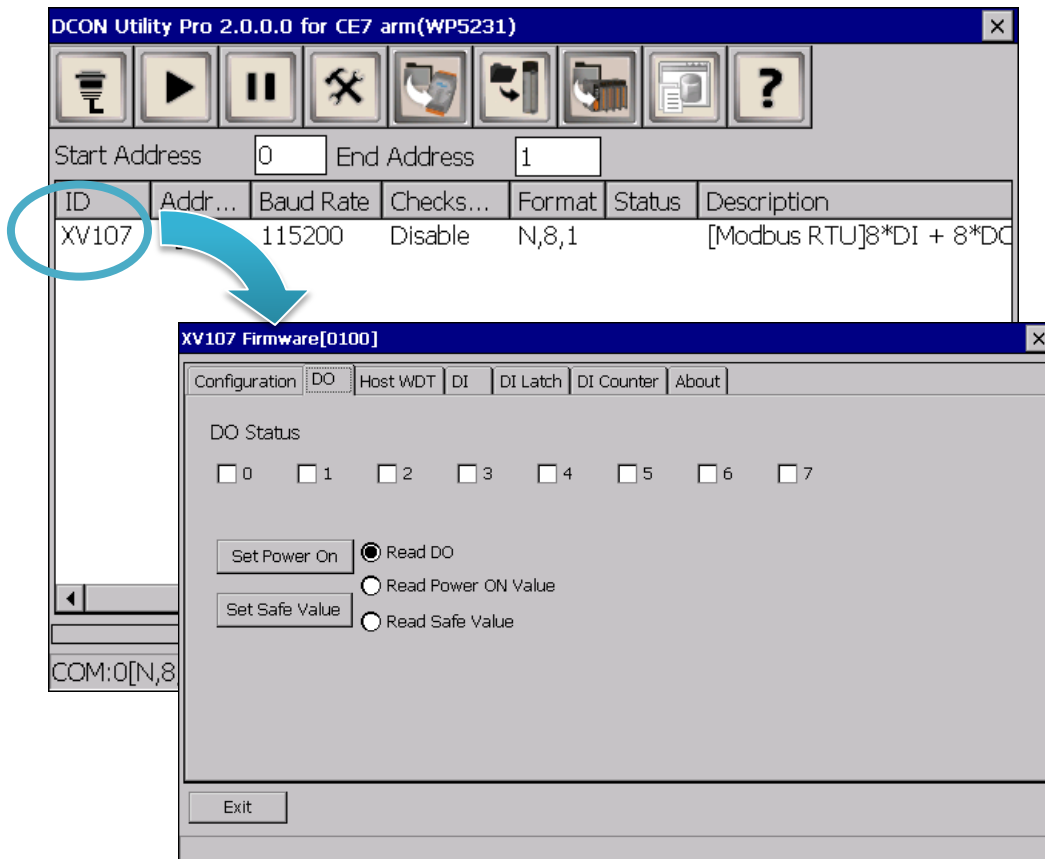

## 2.6. Changing the User Interface Language

The Windows CE operating system on the WinPAC comes with several built-in functions.

**Step 1: Click Start menu, point to Settings, click Control Panel, and then click Regional Settings Options**

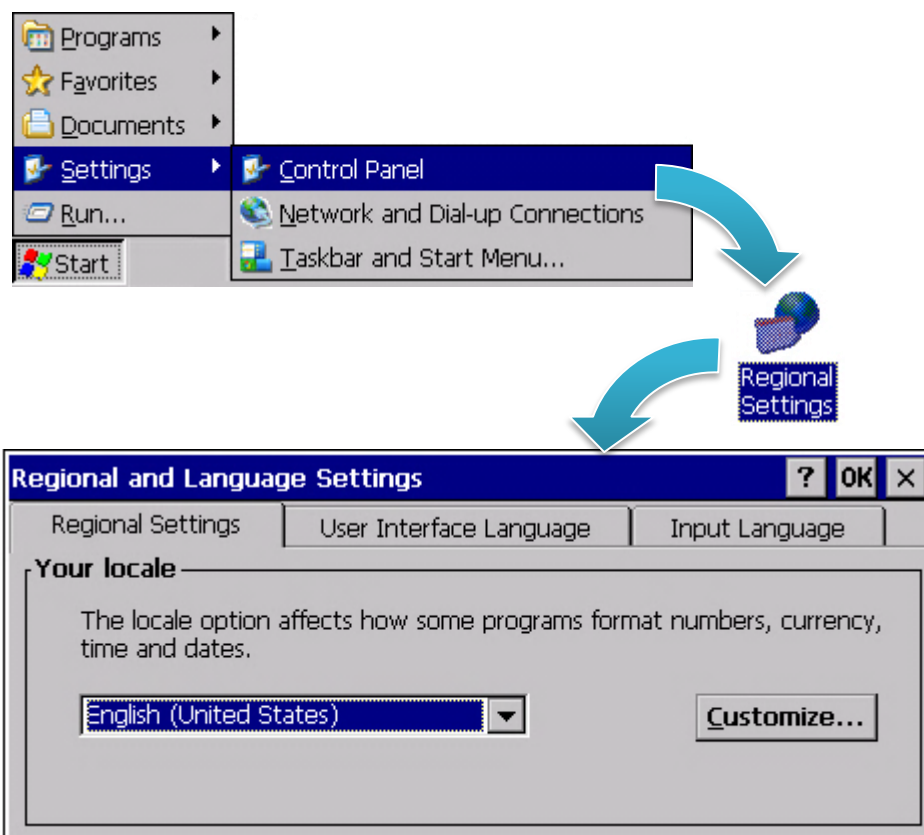

**Step 2: Click User Interface Language tab, choose to your local language, and then click OK**



**Step 3: Run the PAC Utility, and then reboot the WinPAC for changes to take effect**

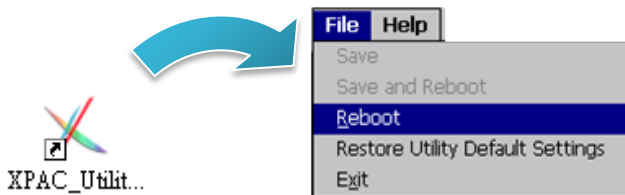

### 3. Tools and Tasks

This chapter provides a brief introduction of the WP-5231 service tools and its benefits.

There are several tools and utilities built-in and designed for use with WP-5231. Some of these are pre-installed on WP-5231 and can work directly on WP-5231, and some of these are supporting tools and can help you to manage the WP-5231 remotely on a PC.

The following tools are pre-installed on WP-5231 and can work directly on WP-5231 that can be found on the CD that was provided with the package or by downloading the latest version from ICP DAS web site.

CD:\wp-5231\System\_Disk\Tools\

[http://ftp.icpdas.com/pub/cd/winpac\\_am335x/wp-5231/system\\_disk/tools/](http://ftp.icpdas.com/pub/cd/winpac_am335x/wp-5231/system_disk/tools/)

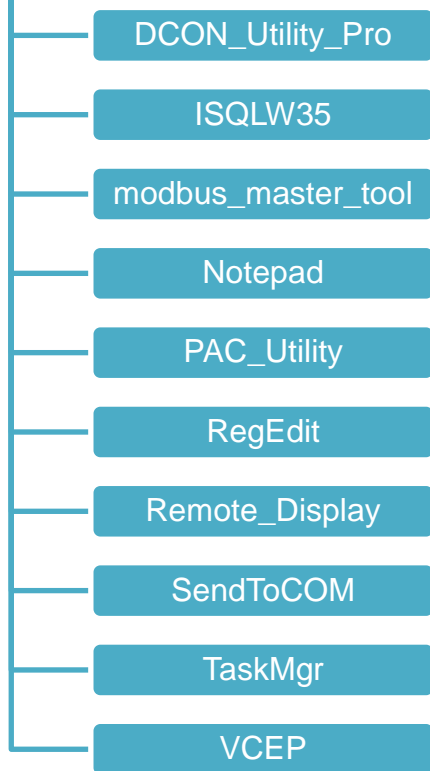

The following tools are supporting tools for remote managing the WP-5231 used on PC that can be found on the CD that was provided with the package or by downloading the latest version from ICP DAS web site.

CD:\wp-5231\PC\_Tools\  
http://ftp.icpdas.com/pub/cd/winpac\_am335x/wp-5231/pc\_tools/

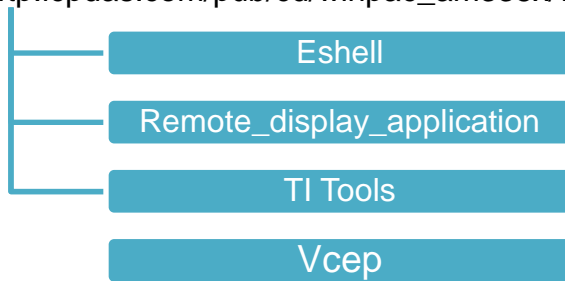



## 3.1. PAC Utility

PAC Utility is a collection of software applications that enable management and configuration of WinPAC system and features.

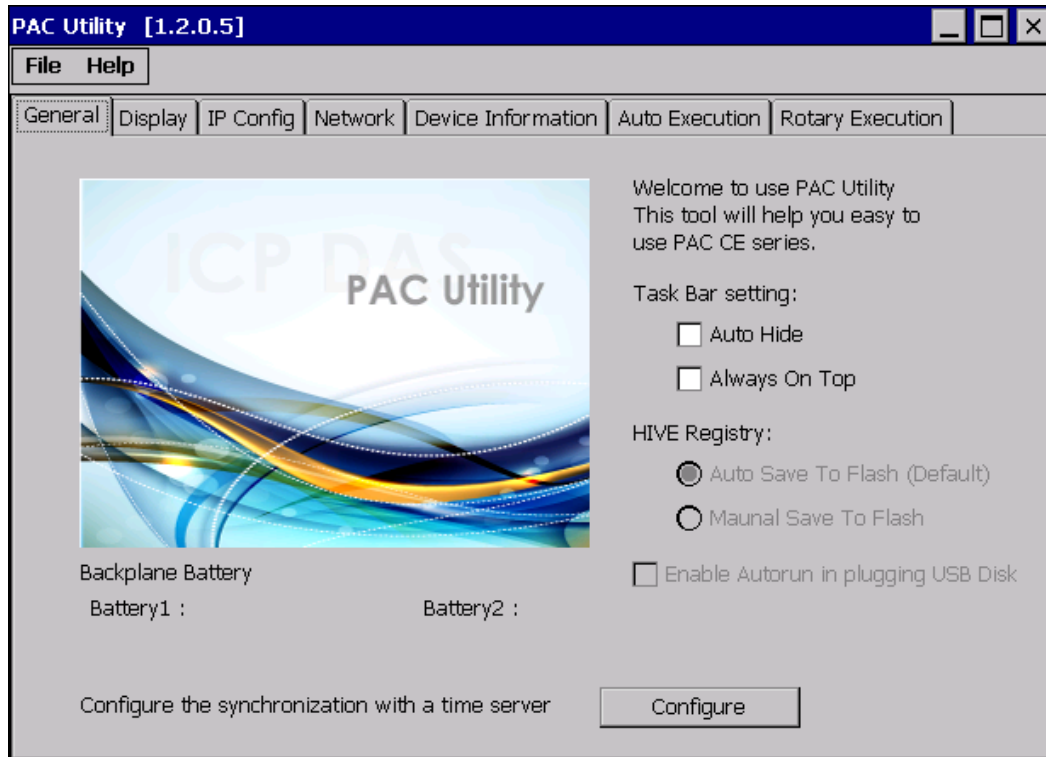

The PAC Utility includes the following menu bars and property tabs. All of these functions will be explained later.

Menu bar	Property Tab
<ul style="list-style-type: none"> <li>➤ File</li> <li>➤ Help</li> </ul>	<ul style="list-style-type: none"> <li>➤ General</li> <li>➤ General2</li> <li>➤ Display</li> <li>➤ IP Config</li> <li>➤ Network</li> <li>➤ Device Information</li> <li>➤ Auto Execution</li> <li>➤ Rotary Execution</li> </ul>

### 3.1.1. Menu Bar – File

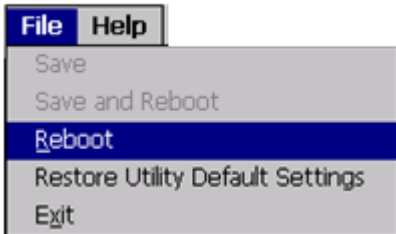

The menus use to	How to use
Reboot	Restarts the WinPAC
Restore Default Settings	Restore the settings of WinPAC to its default.
Exit	Exits the PAC Utility.

### 3.1.2. Menu Bar – Help

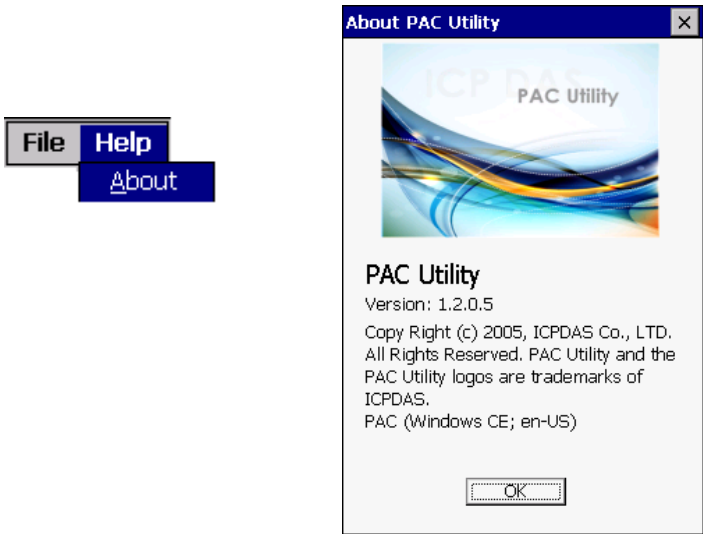

The menus use to	How to use
About	Displays a dialog box with information about PAC Utility, including the current version and copyright information.

### 3.1.3. Property Tab - General

The General tab provides functions to configure the task bar, check the status of the battery..., etc.

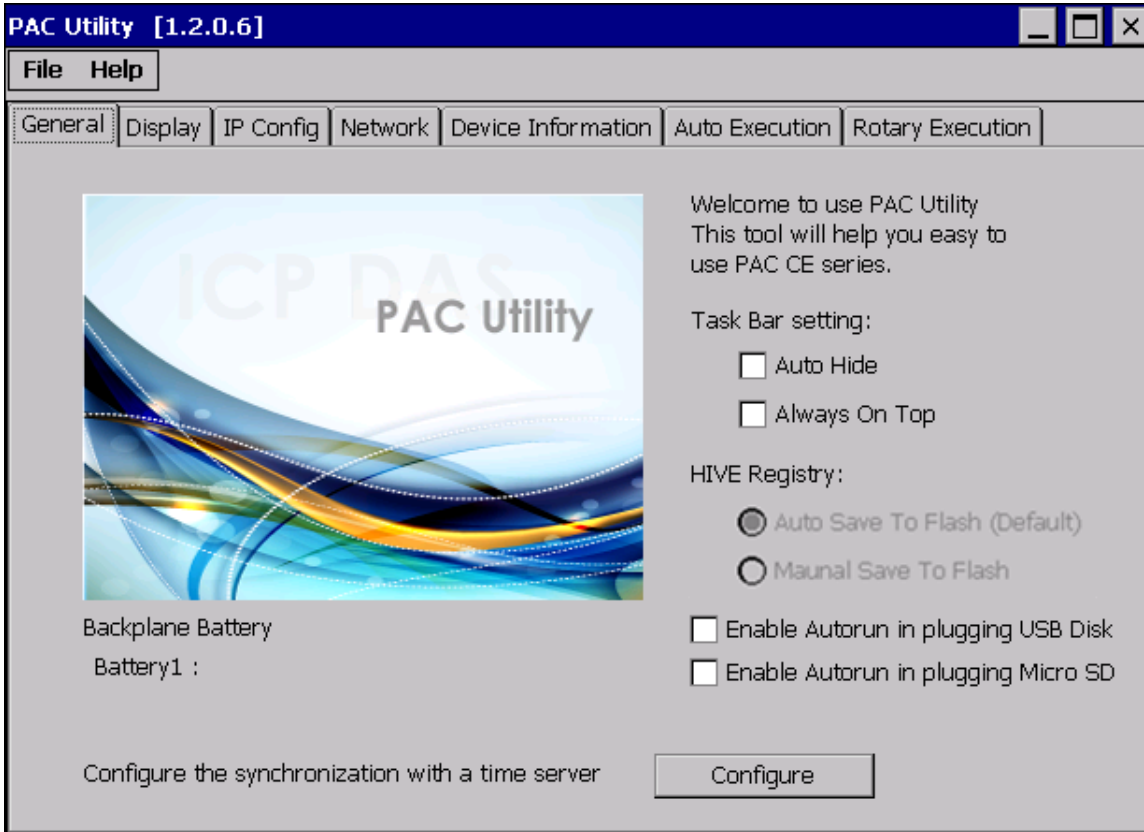

The tab use to	How to use
Lock or Auto-Hide the taskbar	<p><b>Auto-Hide:</b> Select the <b>Auto Hide</b> check box.</p> <p><b>Lock:</b> Select the <b>Always On Top</b> check box.</p>
Auto save or manual save to flash	<p>By default, these options are unavailable.</p> <p><b>Auto save to flash:</b> This option is checked by default. Any changes made to the WP-5231 will be saved and only take effect after the WP-5231 reboots.</p> <p><b>Manual save to flash:</b> This option is useless.</p>

The tab use to	How to use
Check the status of the battery	See the <b>Battery1</b> field that displays the display resolution.
Automatic synchronization of system time	Refer to the Appendix A.2. How to configure the service for automatically synchronizing with the internet time server.

### 3.1.4. Property Tab – Display

The Display tab provides functions to configure the monitor settings.

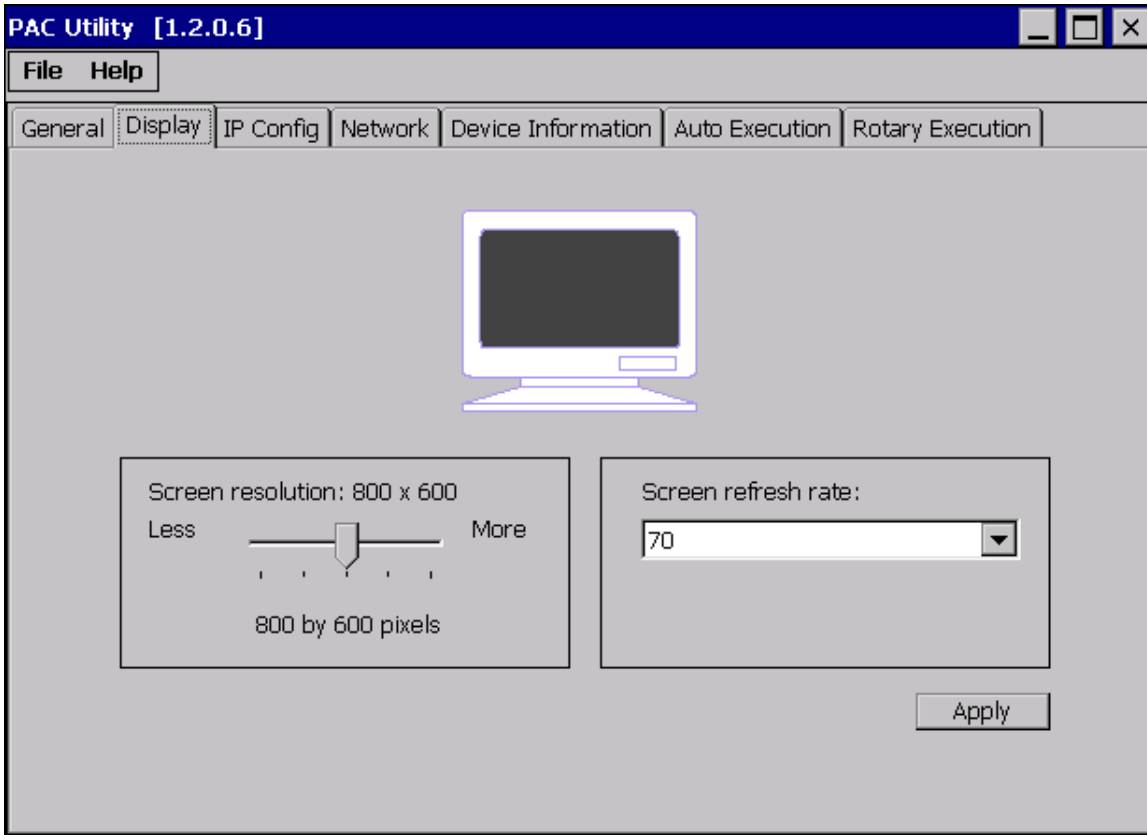

The tab use to	How to use
Adjust the screen resolution	Move the slider to the left to decrease the resolution or move the slider to the right to increase the resolution, and then click the <b>Apply</b> button.
Change the screen refresh rate	Select the desired refresh rate from the <b>Screen refresh rate</b> drop-down list, and then click the <b>Apply</b> button.

### 3.1.5. Property Tab – IP Config

The IP Config tab provides functions to configure either DHCP (Roaming) or manually configured (Static) network settings and to monitor the MAC address. Generally, DHCP is the default settings, but if you don't have a DHCP server, you must configure the network settings by using manual configuration.

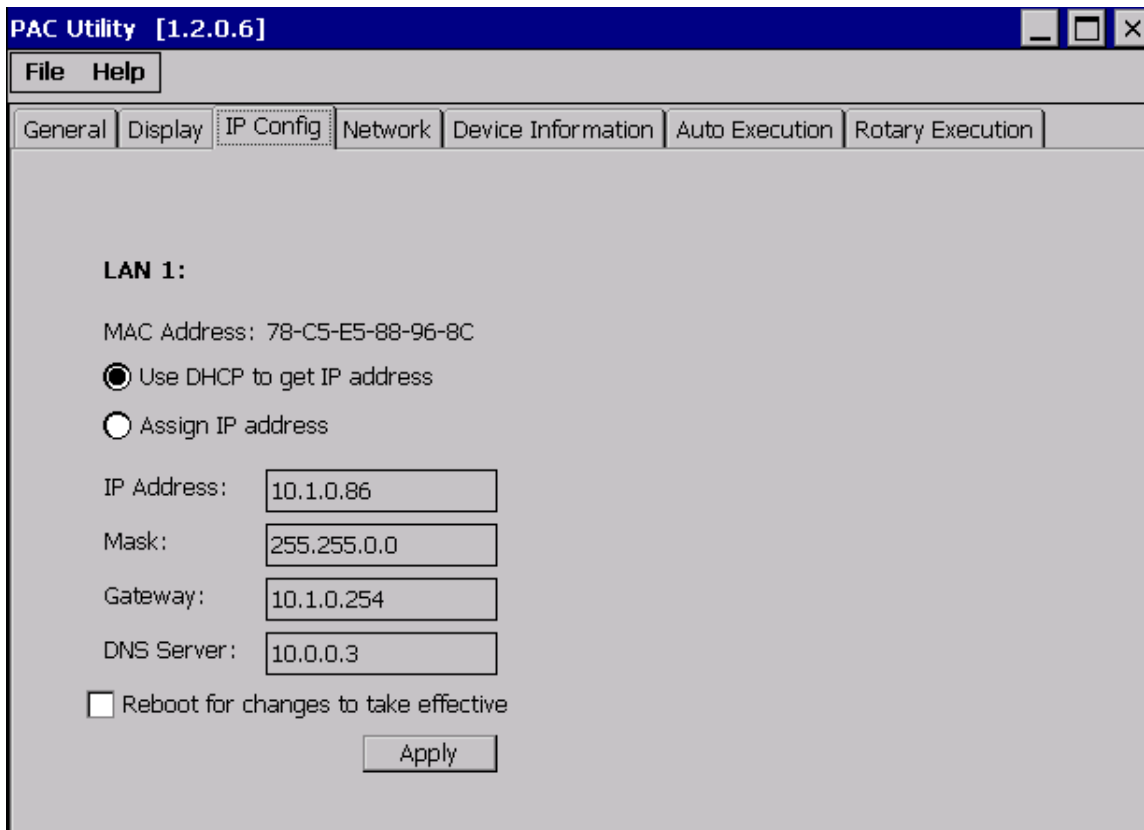

The tab use to	How to use
Set the network settings	<p><b>Use DHCP to get IP address:</b> Select the <b>Use DHCP to get IP address</b> option, and then click the <b>Apply</b> button.</p> <p><b>Assign an IP address:</b> Select the <b>Assign IP address</b> option, and then click the <b>Apply</b> button.</p>

### 3.1.6. Property Tab – Network

The Network tab comprises three tabs – Access, Login and File Server Settings.

#### Access

The Access tab provides functions to enable/disable the FTP access, enable/disable anonymous FTP access, and configure the FTP and HTTP directory path.

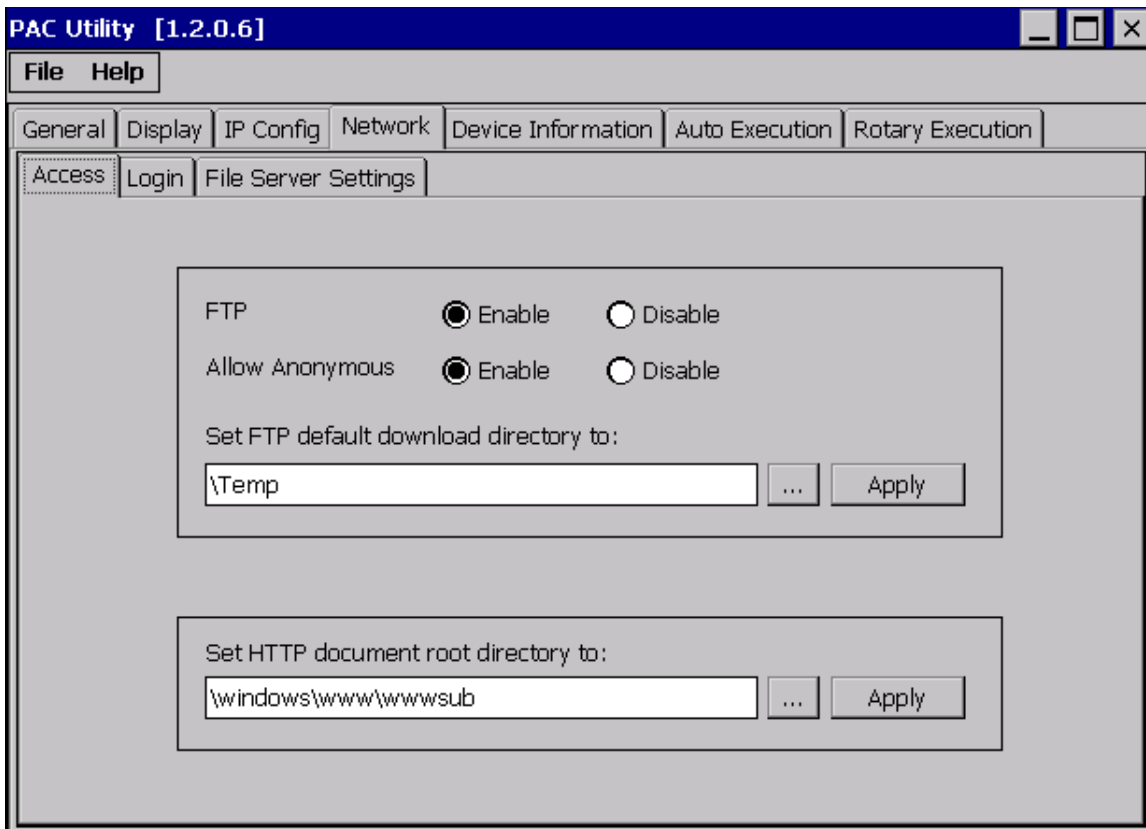

The tab use to	How to use
Enable or disable the FTP access	<p><b>Enable:</b> Select the <b>Enable</b> check box in the <b>FTP</b> field, and then click the <b>Apply</b> button.</p> <p><b>Disable:</b> Select the <b>Disable</b> check box in the <b>FTP</b> field, and then click the <b>Apply</b> button.</p>



The tab use to	How to use
Enable or disable anonymous FTP access	<p><b>Enable:</b></p> <p>Select the Enable check box in the <b>Allow Anonymous</b> field, and then click the <b>Apply</b> button.</p> <p><b>Disable:</b></p> <p>Select the Disable check box in the <b>Allow Anonymous</b> field, and then click the <b>Apply</b> button.</p>
Set the FTP directory path	Enter a new path in the <b>Set FTP default download directory to:</b> field, and then click the <b>Apply</b> button.
Set the HTTP directory path	Enter a new path in the <b>Set HTTP document root directory to:</b> field, and then click the <b>Apply</b> button.

## Login

The Login tab provides functions to maintain the FTP accounts.

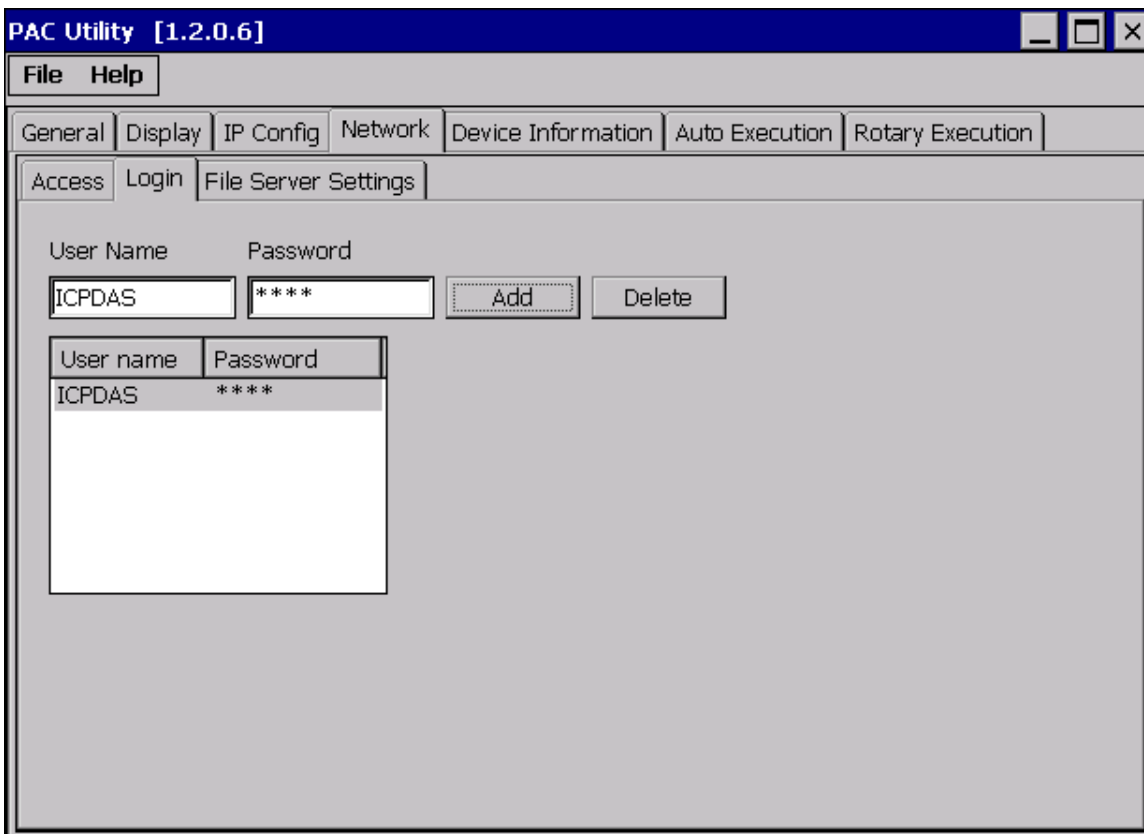

The tab use to	How to use
Maintain the FTP accounts	Refer to the Appendix C.1 How to add a user account to remote login the WinPAC from PC.

## File Server Settings

The File Server Settings tab provides functions to set the SMB server.

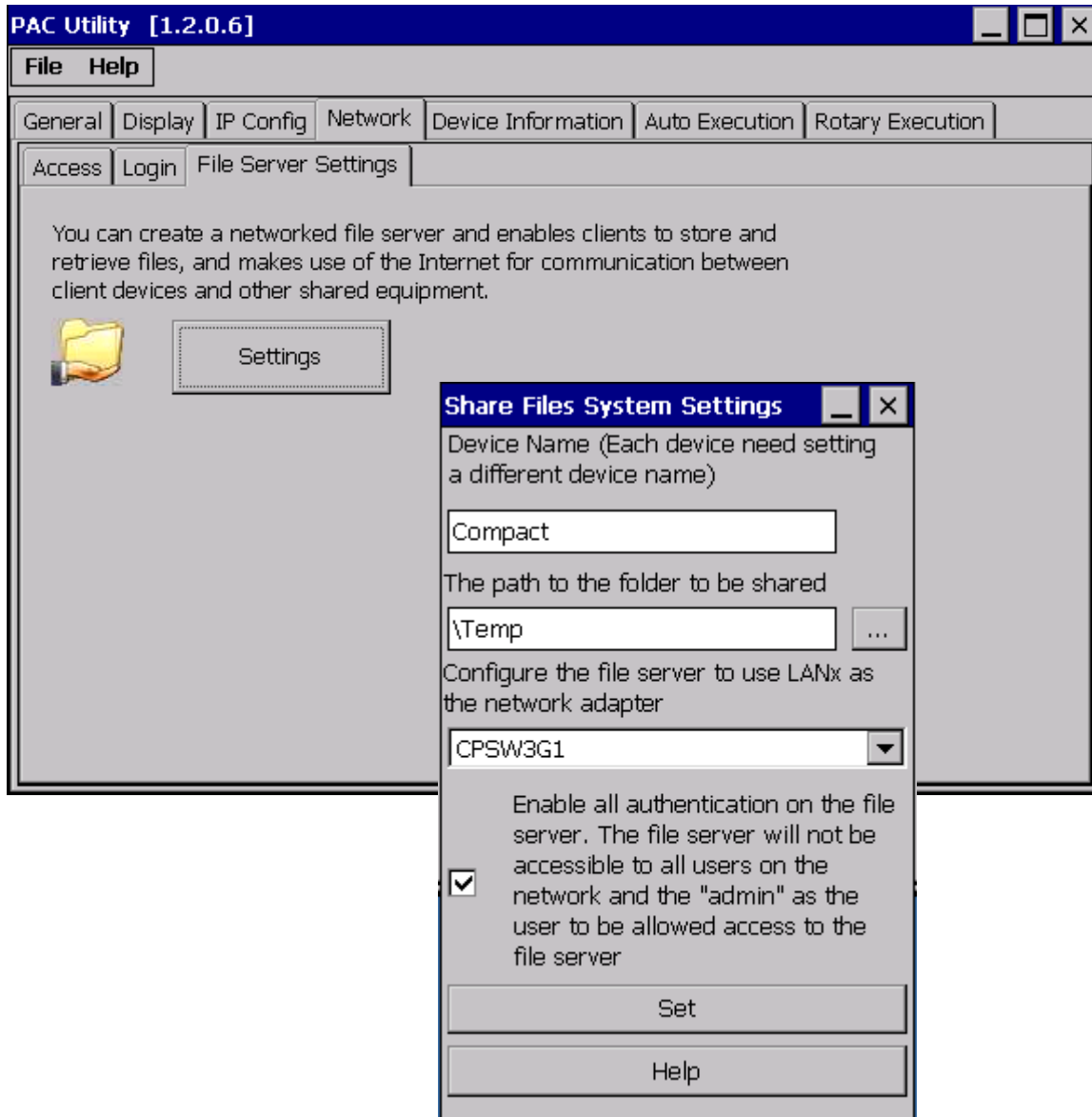

The tab use to	How to use
Set the SMB server	Click the Settings button to set the SMB server path.

### 3.1.7. Property Tab – Device Information

The Device Information tab provides functions to monitor necessary system information of the WinPAC. The information is the most important note of version control for upgrading system.

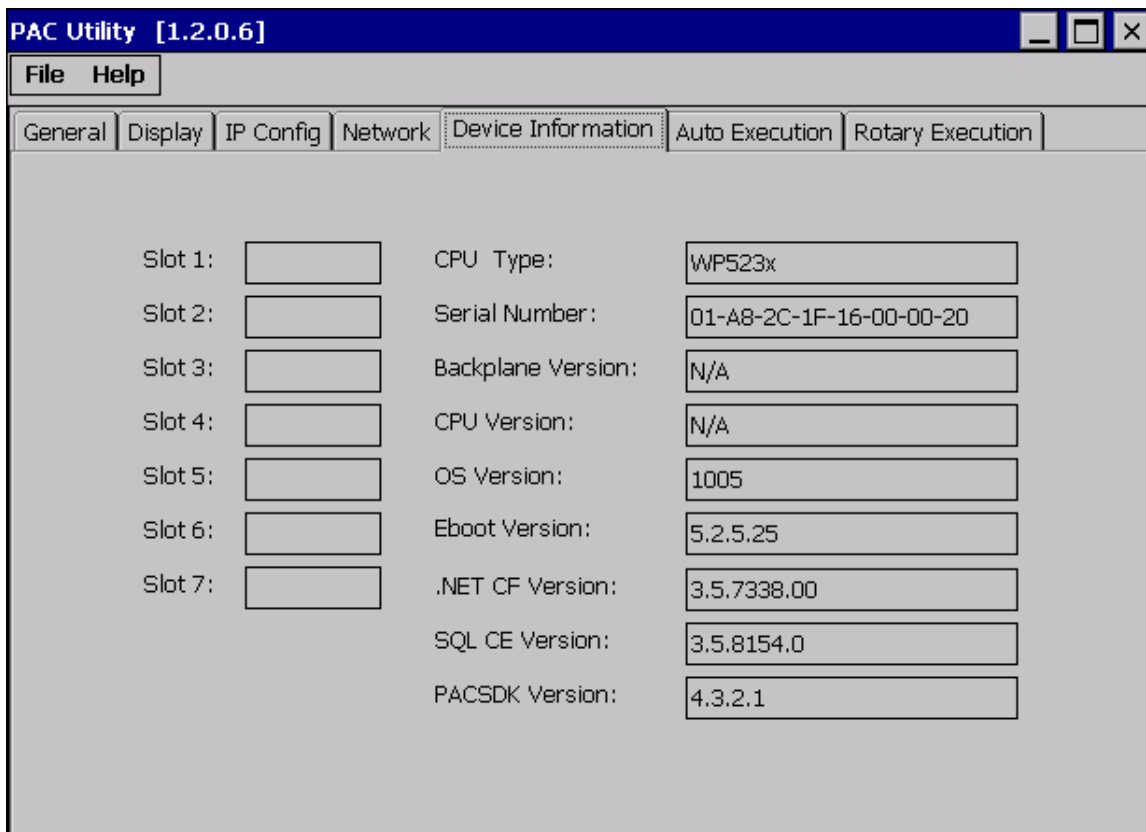

### 3.1.8. Property Tab – Auto Execution

The Auto Execution tab provides functions to configure programs running at WinPAC startup, it allows users to configure ten execute files at most.

#### Tips & Warnings



The specific extensions are .exe and .bat, and they are executed in order of program 1, program 2, etc.

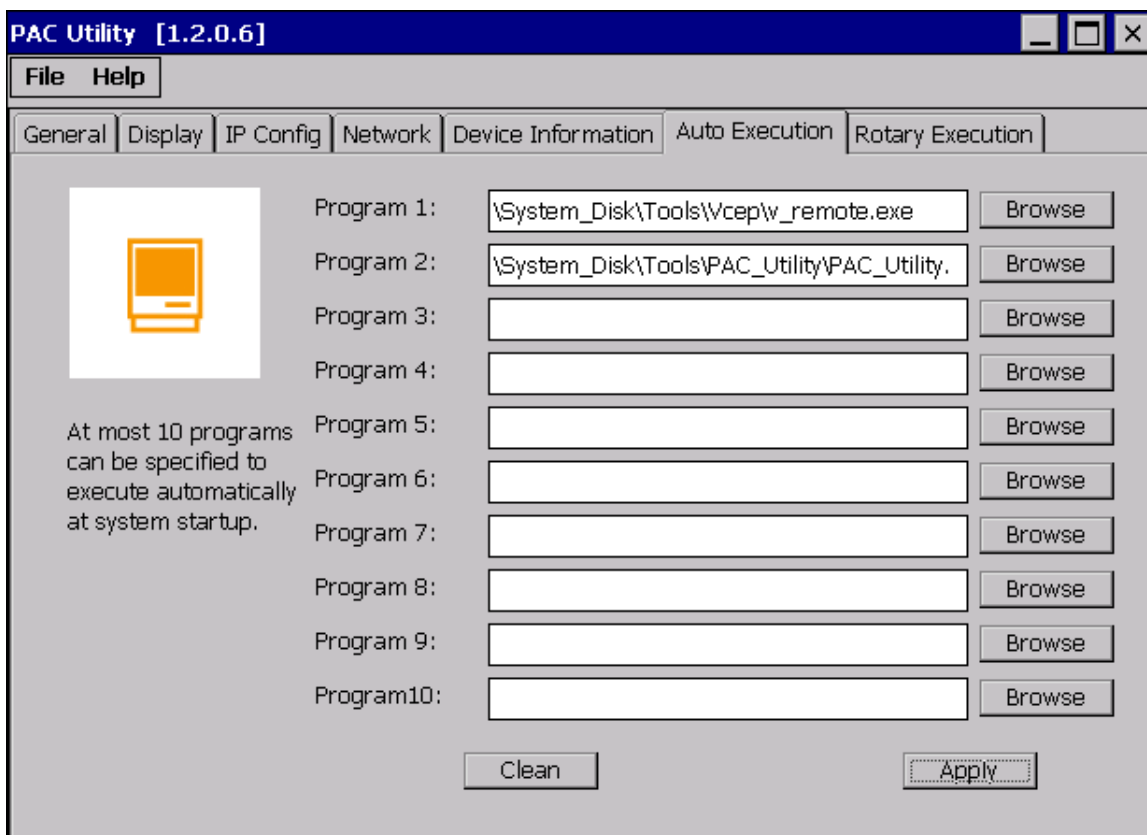

The tab use to	How to use
Configure programs running at startup	Click the <b>Browse</b> button to select the execute file which you want, and then click the <b>Apply</b> button.

### 3.1.9. Property Tab – Rotary Execution

The Rotary Execution tab provides functions to configure programs running at WinPAC startup in one of the user defined mode, it allows users to configure ten execute files at most.

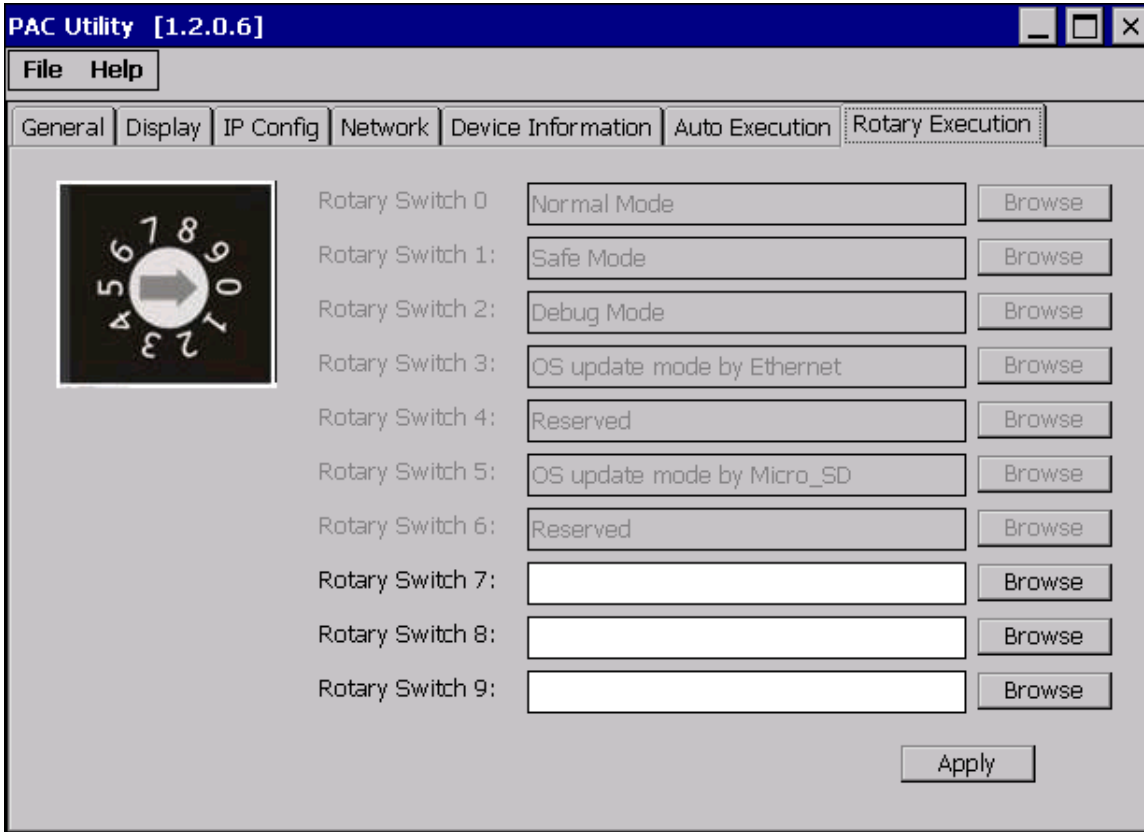

The tab use to	How to use
Configure programs running at startup in one of the user defined mode	Click the <b>Browse</b> button to select the execute file which you want, and then click the <b>Apply</b> button.

## 3.2. DCON Utility Pro

DCON Utility Pro enables users easily to configure and manage the I/O modules via Ethernet or serial ports (RS-232/RS-485).

For more detailed information on how to use DCON Utility Pro to configure I/O modules, please refer to “2.5. Using DCON Utility Pro to Configure I/O Modules”

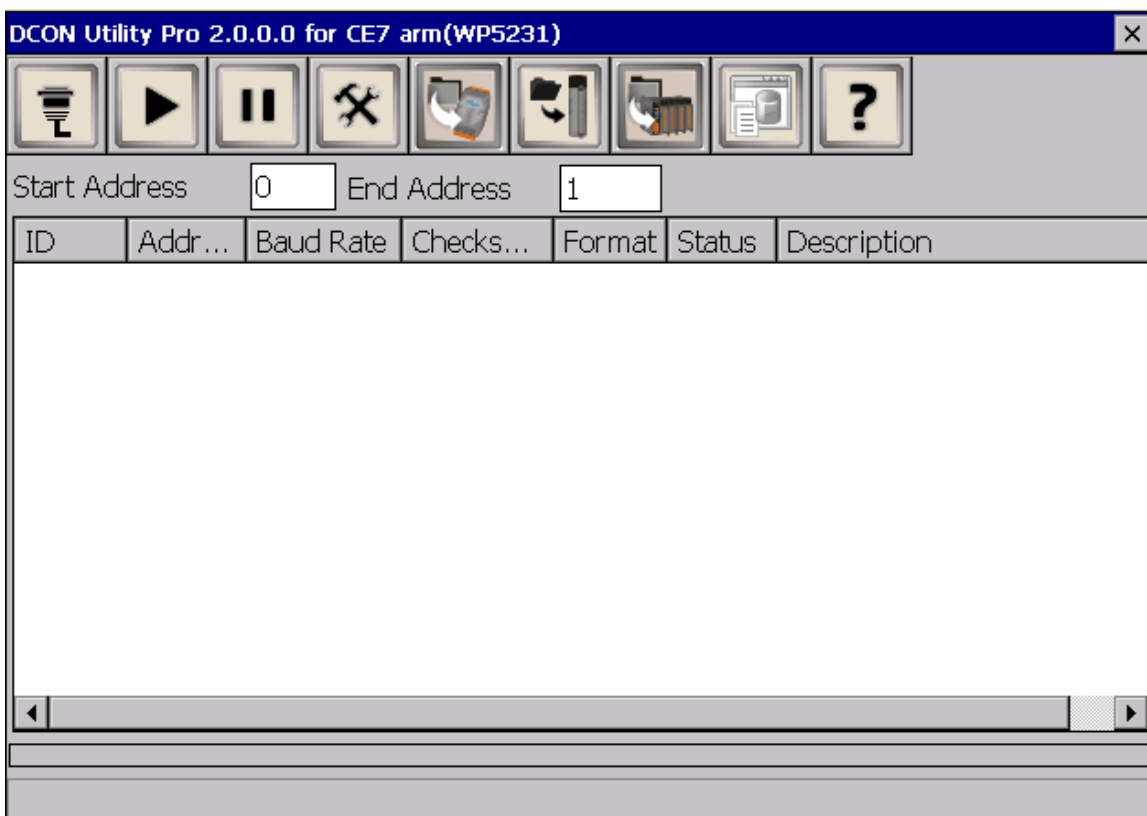

### 3.3. TaskMgr

The TaskMgr is a Windows CE application, which provides real time info on all processes and threads including System threads, similar in appearance to the Windows Task Manager.

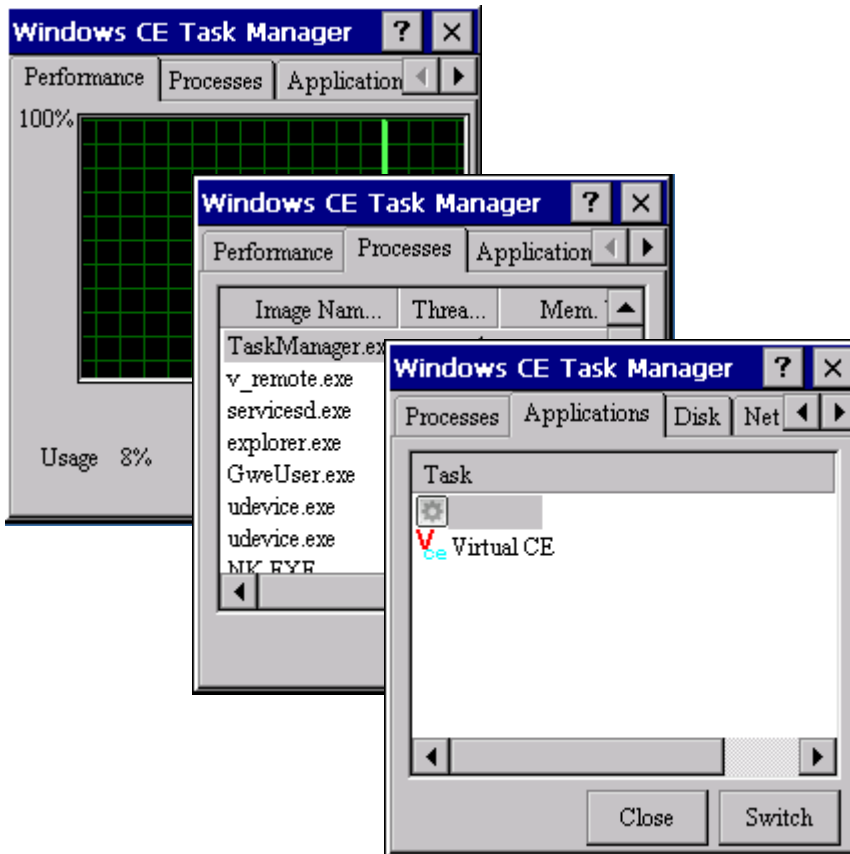

## 3.4. VCEP

ICPDAS VCEP is designed for managing your WinPAC anywhere. No matter where you are, ICPDAS VCEP provides a convenient environment on the Desktop PC and lets you control your WinPAC remotely.



ICPDAS VCEP is composed of two main components: The “Server” which runs on WinPAC and the ‘Client’ which runs on a Desktop PC.

Once a connection is established between the client and server (initiated by the client), the client will periodically send requests for screen updates and send mouse/key click information to the server to simulate.

Each video frame is inter-compressed against the previous frame and then intra-compressed with a modified LZW scheme to minimize the amount of data transmitted from server to client.

For more detailed information on VCEP application, please refer to

[http://ftp.icpdas.com.tw/pub/cd/winpac/napdos/wp-8x4x\\_ce50/pc\\_tools/vcep\\_5.0.0.0/](http://ftp.icpdas.com.tw/pub/cd/winpac/napdos/wp-8x4x_ce50/pc_tools/vcep_5.0.0.0/)



## 3.5. Remote\_Display

The "Remote Display" allows WinPAC to be controlled and monitored from a remote location. This tool is composed of two parts, a client and a server. The server is a program named cerdisp.exe running on WinPAC. The client is a PC-based program named cerhost.exe running on the PC.

## 3.6. SendToCOM

The SendToCOM uses the serial port to communicate with expansion module. To use the SendToCOM, you can send data to expansion module through the serial port, and receive data from other device through the serial port.

For more information about these commands for communicating with expansion module, please refer to:

[http://www.icpdas.com/root/product/solutions/remote\\_io/rs-485/i-8k\\_i-87k/i-8k\\_i-87k\\_selection.html#b](http://www.icpdas.com/root/product/solutions/remote_io/rs-485/i-8k_i-87k/i-8k_i-87k_selection.html#b)

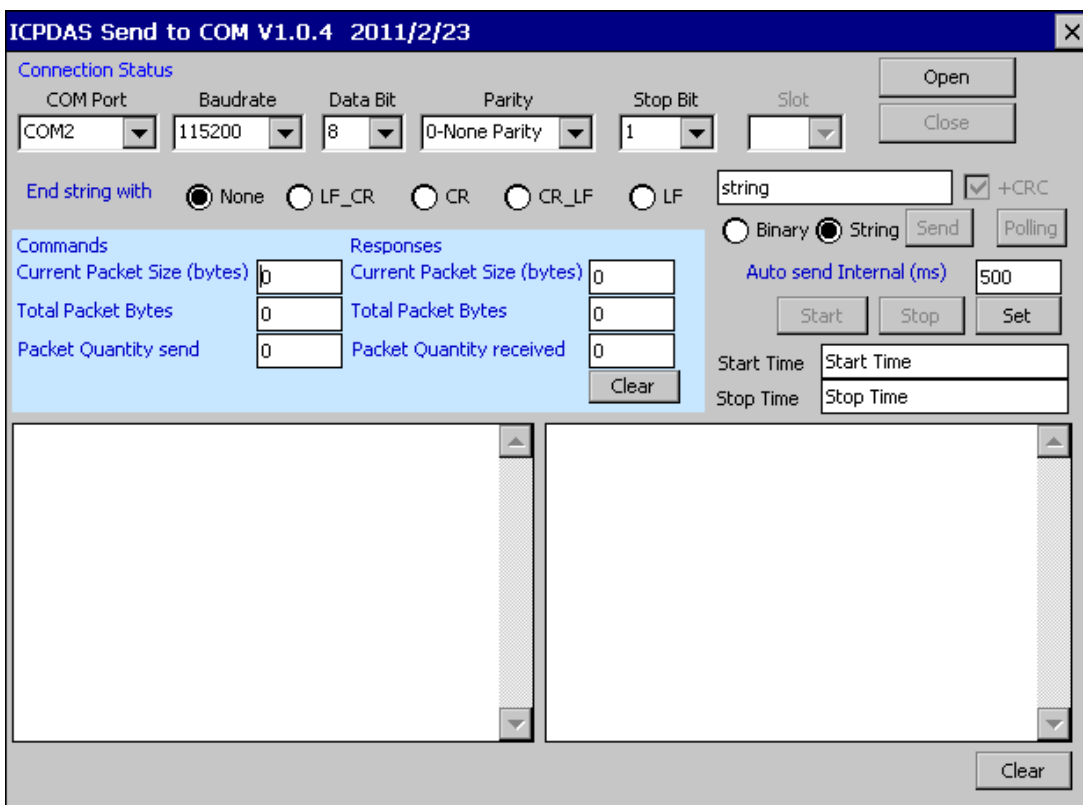

## 3.7. RegEdit

The RegEdit provides a hierarchical representation of the registry on a target computer, similar in appearance to the Windows Registry Editor. The standard registry roots are represented; you can add keys beneath a root to point to existing registry keys, or you can add your own keys. Values can be changed for existing keys, or added for new keys, and default keys can be specified. For more information, see Registry Settings Management in Deployment.

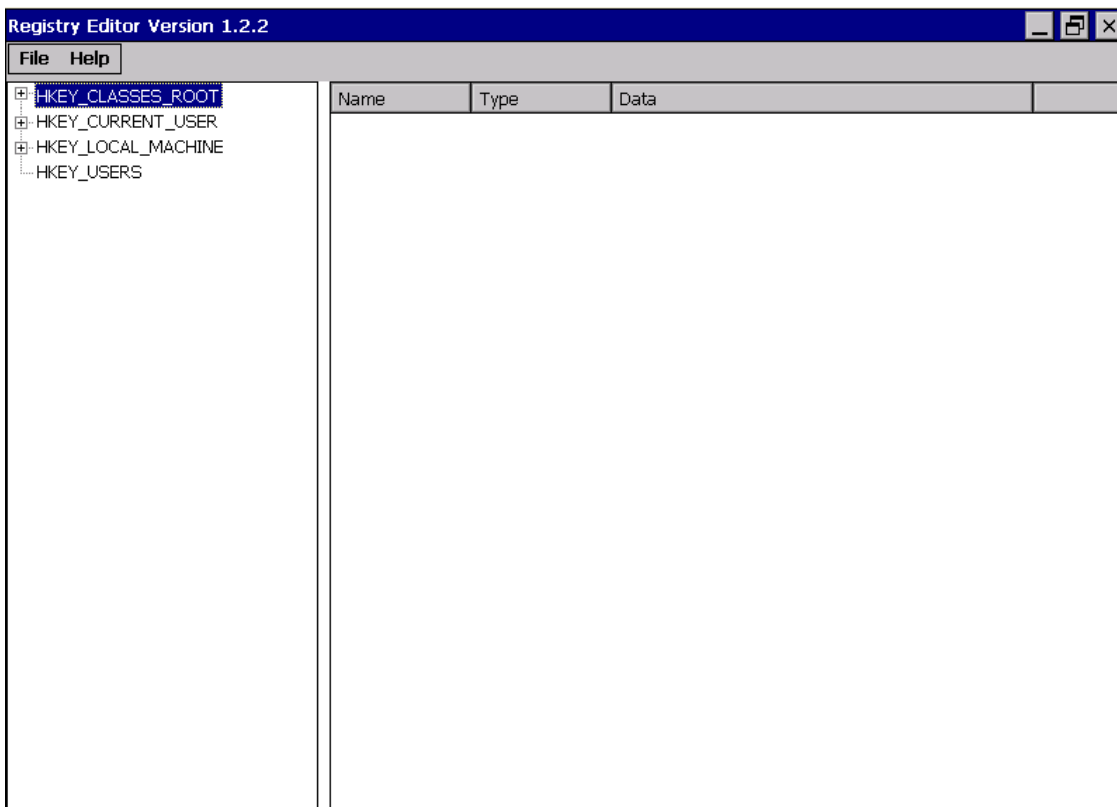

## 3.8. ISQLW35

The "ISQLW35" is a Windows Embedded Compact 7 functionality that implements SQL Server Compact 3.5 Query.

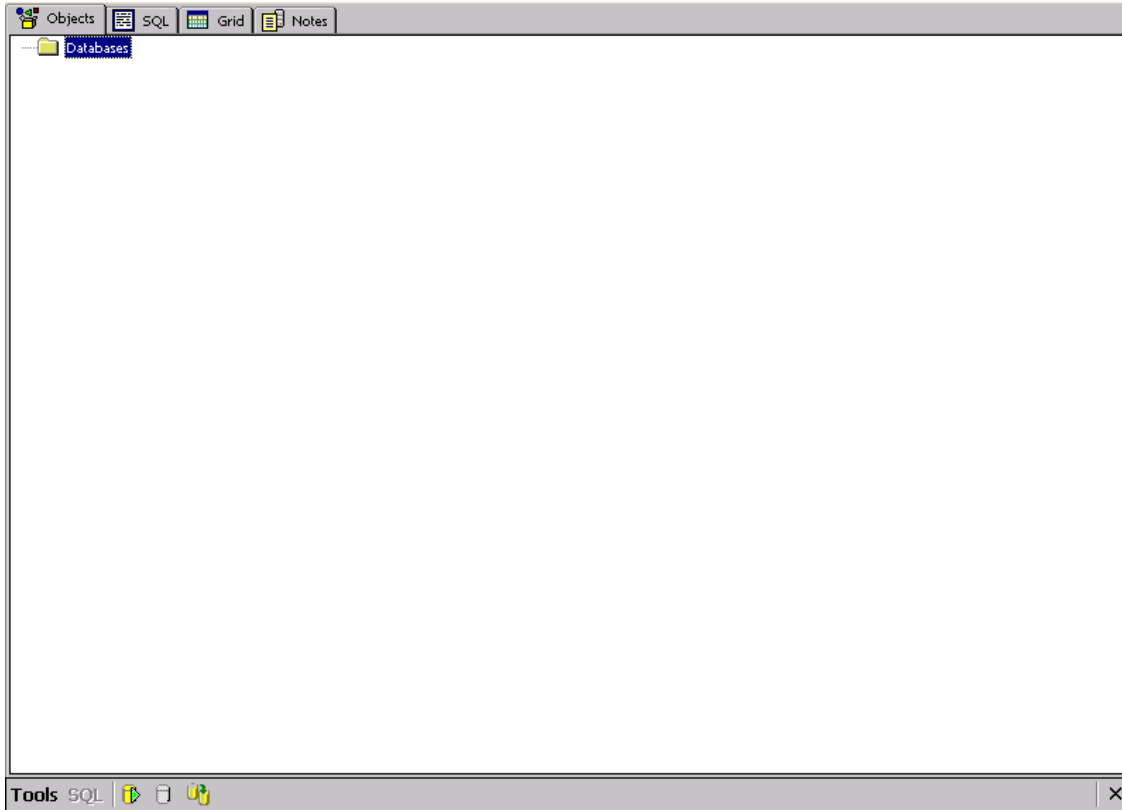

## 3.9. INotepad

The INotepad is a common text-only editor. The resulting files have no format tags or styles, making the program suitable for editing system files that are to be used in a DOS environment.

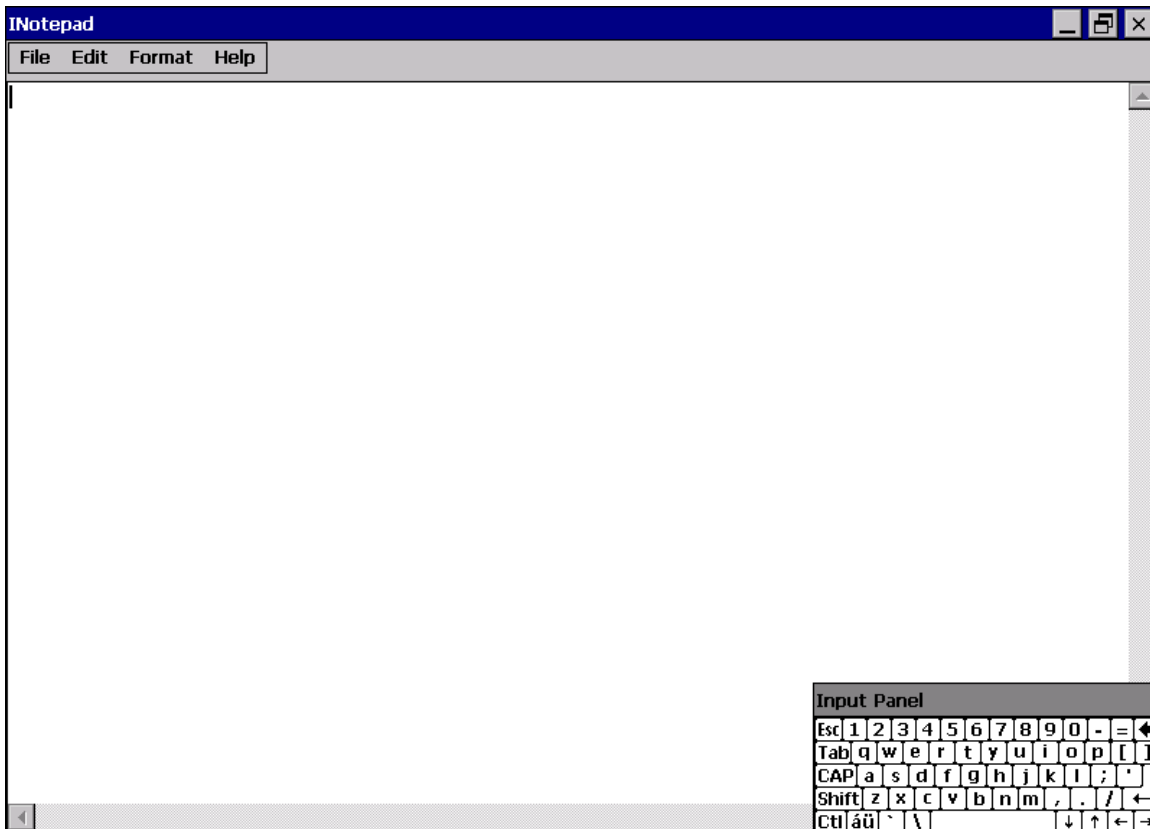

# 4. Your First WinPAC Program

This chapter provides a guided tour that describes the steps needed to set-up a development environment, download, install, configure for user programming with the WP-5231 series modules.

Before writing your first program, ensure that you have the necessary development tool and the corresponding WinPAC SDKs are installed on your system.

## Development Tools

---

WP-5231 series modules are Windows CE-based units. Windows CE is a mature embedded operating system which supports rapid development.

The table below lists the supported development tools and development languages to develop WP-5231 applications.

Development Tools		Languages	Visual Basic.Net	Visual C#	Visual C++
Visual Studio 2005 or earlier	Any versions except Professional	-	-	-	
	Professional	-	-	-	
Visual Studio 2008	Any versions except Professional	-	-	-	
	Professional	√	√	√	
Visual Studio 2012 or later	Any versions except Professional	-	-	-	
	Professional	-	-	-	

## 4.1. Preparing the Development Tools

WP-5231 is a Windows CE-based unit. Windows CE is a mature embedded operating system which supports rapid development. The standard development tool is list as follows which is highly integrated, with comprehensive support for developing applications of Windows CE-based WP-5231.

### ➤ Visual Studio 2008

---



WP-5231 has .NET Compact Framework 3.5 installed. Visual Studio 2008 takes full advantage of the .NET Compact Framework, which uses public Internet standards to enable integration with new and existing applications running on any platform. Supported languages include Visual C#, Visual C++ and Visual Basic .NET.

#### Installation Steps:

##### 1. Visual Studio 2008 Professional

Purchase from MSDN subscription

Microsoft DreamSpark:

<https://www.dreamspark.com/Product/Product.aspx?productid=1>

##### 2. Visual Studio 2008 Service Pack 1

<http://www.microsoft.com/en-us/download/details.aspx?id=10986>

##### 3. Visual Studio 2008 update for Windows Embedded Compact 7

<http://www.microsoft.com/en-us/download/confirmation.aspx?id=11935>

##### 4. Windows Embedded Compact 7 ATL Update for Visual Studio 2008 SP1

<http://support.microsoft.com/kb/2468183/en-us>

## 4.2. Installing WP-5231 SDK

The WinPAC SDK is a Software Development Kit (SDK) that contains C header files, C libraries and documents.

### Step 1: Insert the CD into your CD-ROM drive

### Step 2: Execute the “AM335x\_WINCE7\_SDK\_YYYYMMDD.msi”

The AM335x\_WinCE7\_SDK\_YYYYMMDD.msi can be obtained from:  
CD:\wp-5231\SDK\PlatformSDK\

The installation program for the latest version of the WinPAC Platform SDKs can be obtained from:

[http://ftp.icpdas.com/pub/cd/winpac\\_am335x/wp-5231/sdk/platformsdk/](http://ftp.icpdas.com/pub/cd/winpac_am335x/wp-5231/sdk/platformsdk/)

File name: am335x\_wince7\_sdk\_yyyymmdd.msi  
yyyymmdd: platform sdk released date

### Step 3: Follow the prompts until the installation is complete

### Step 4: Execute the “VisualStudioDeviceWindowsEmbeddedCompact7.msi”

The VisualStudioDeviceWindowsEmbeddedCompact7.msi can be obtained from:  
CD:\wp-5231\SDK\PlatformSDK\  
[http://ftp.icpdas.com/pub/cd/winpac\\_am335x/wp-5231/sdk/platformsdk/](http://ftp.icpdas.com/pub/cd/winpac_am335x/wp-5231/sdk/platformsdk/)



**Step 5: Execute any VS2008 C++ project include the AM335x\_WINCE7\_SDK(ARMv4I) platform and the click the “Tools”->”Options...”**

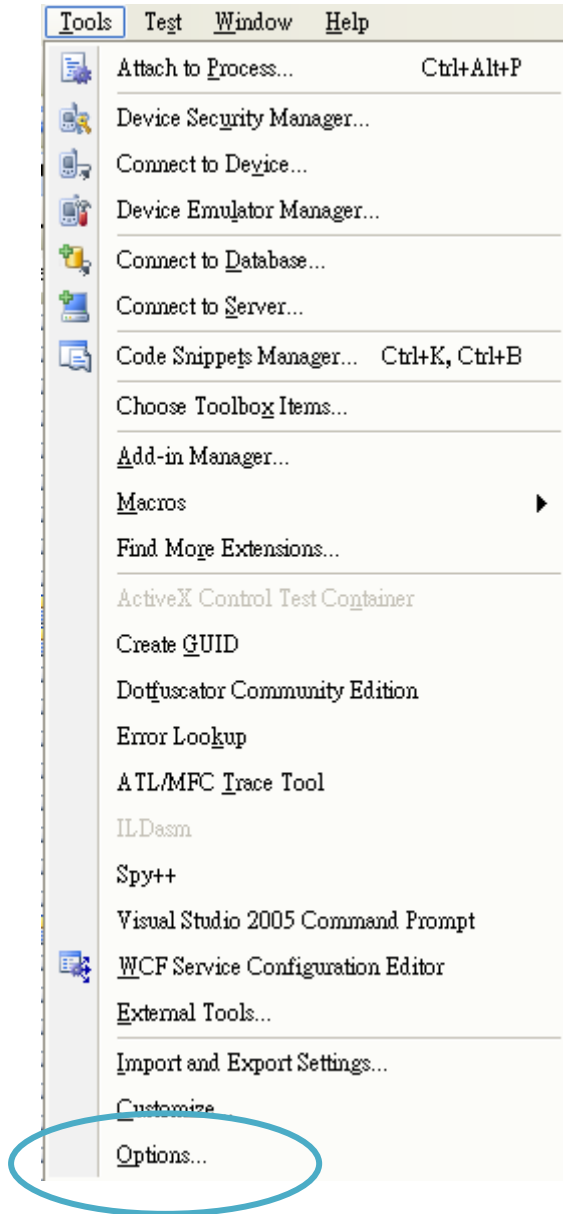

**Step 6: Click the “Projects and Solutions”->”VC++ Directories” and then select the “AM335x\_WINCE7\_SDK (ARMv4I)” 、 “Include files” at “Platform:” and “Show directories for:” item**

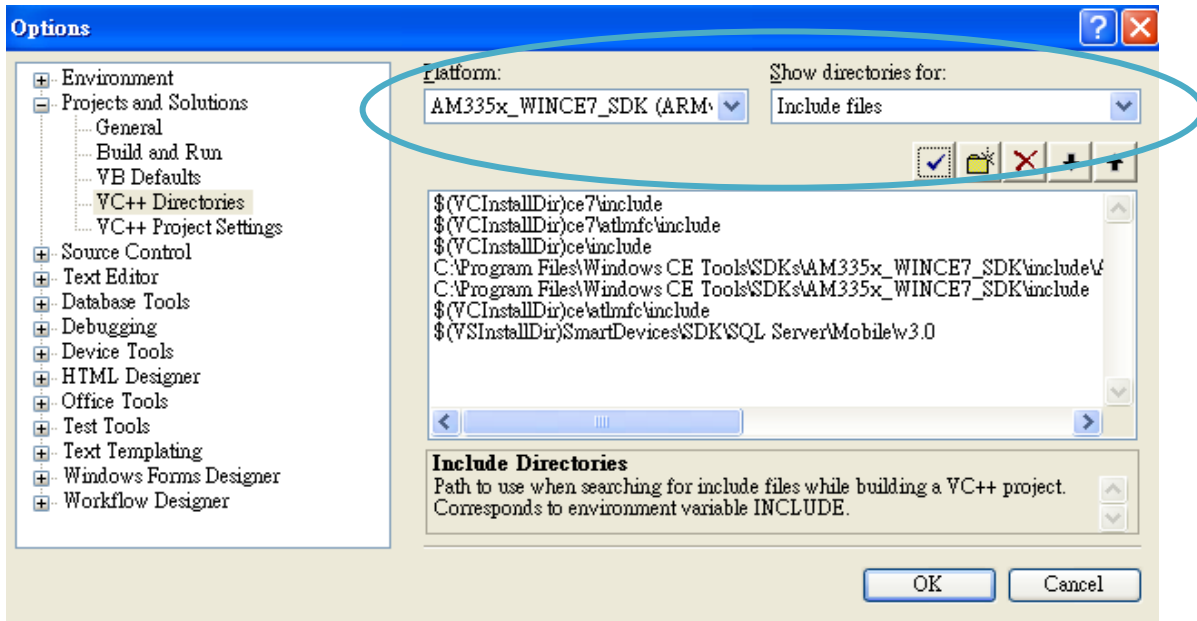

**Step 7: Add the path “\$(VCInstallDir)ce7\include” and “\$(VCInstallDir)ce7\atlmfc\include” and then click the OK button.**

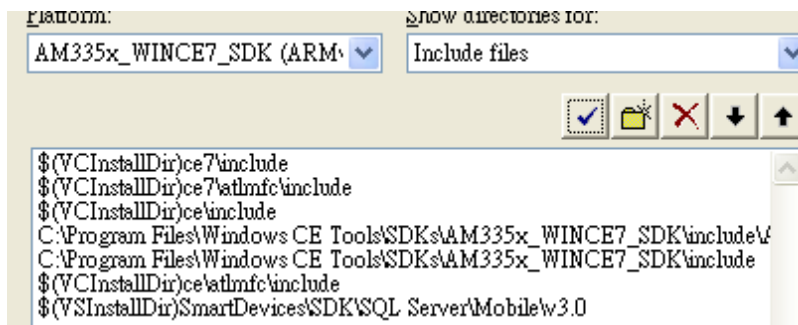

### Tips & Warnings



The path “\$(VCInstallDir)ce7\include” and “\$(VCInstallDir)ce7\atlmfc\include” must be on the top of box.

## 4.3. First WinPAC Program in VB.NET

The best way to learn programming with WinPAC is to actually create a WinPAC program.

The example below demonstrates how to create a demo program running on WinPAC with VB.NET.

To create a demo program with VB.NET that includes the following main steps:

1. Create a new project
2. Specify the path of the PAC reference
3. Add the control to the form
4. Add the event handling for the control
5. Upload the application to WP-5231
6. Execute the application on WP-5231

All main steps will be described in the following subsection.

In this tutorial, we will assume that you have installed WP-5231 SDK on PC and used the Visual Studio 2008 for application development.

## 4.3.1. Create a New Project

The Visual VB.net project template is a composite control that you use in this example creates a new project with this user control.

### Step 1: Run the Visual Studio 2008

Visual Studio 2008



### Step 2: On the File menu, point to New, and then click Project

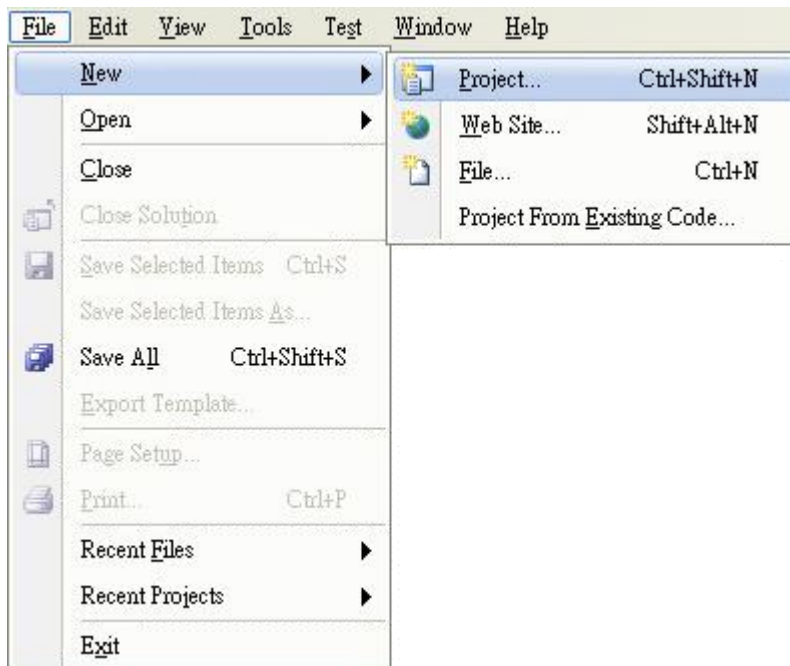

**Step 3: In the Project types pane, expand Visual Basic, and then click Smart Device**

**Step 4: In the Templates pane, click Smart Device**

**Step 5: Type a name in the Name field, and then click OK**

Here we will enter the name “SDKInformation” and a different location for the project if you wish

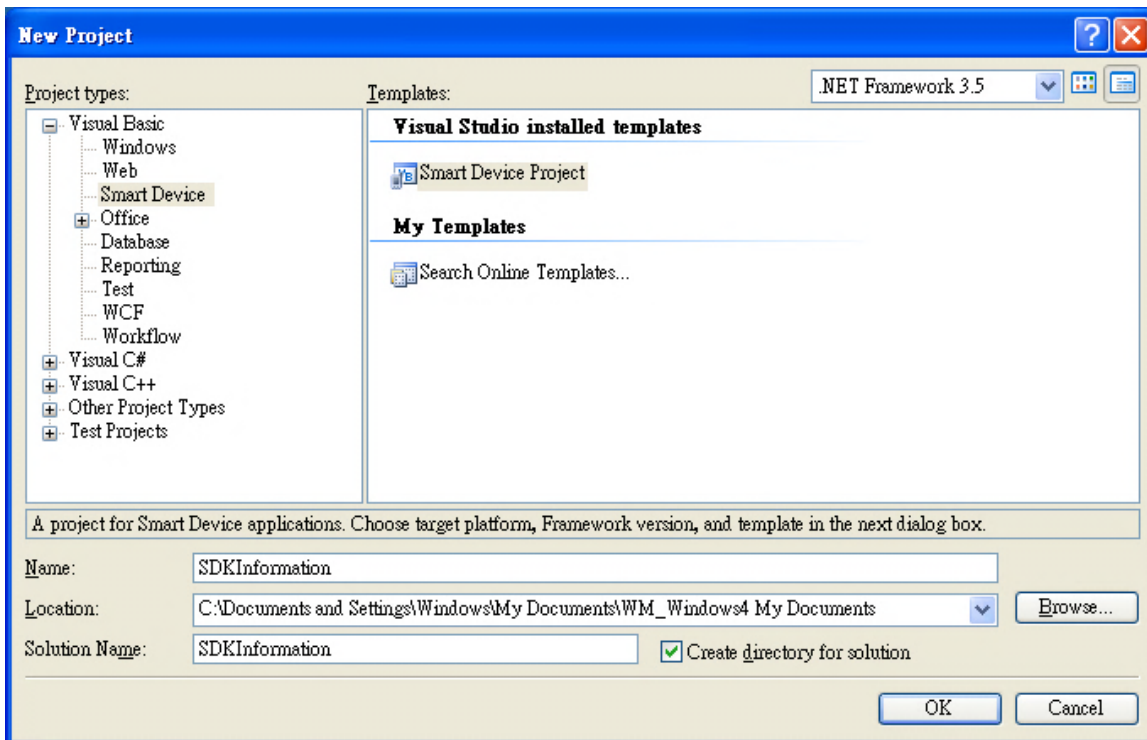

## Tips & Warnings



The WCE7 only support .NET Compact Framework Version 3.5, if your application uses .NET Compact Framework Version 2.0 there is no guarantee that the program will function correctly.

**Step 6: In the Target platform item, choose Windows CE**

**Step 7: in the .NET Compact Formwork version item, choose .NET Compact Framework Version 3.5**

**Step 8: in the Templates pane, choose Device Application, and then click Next**

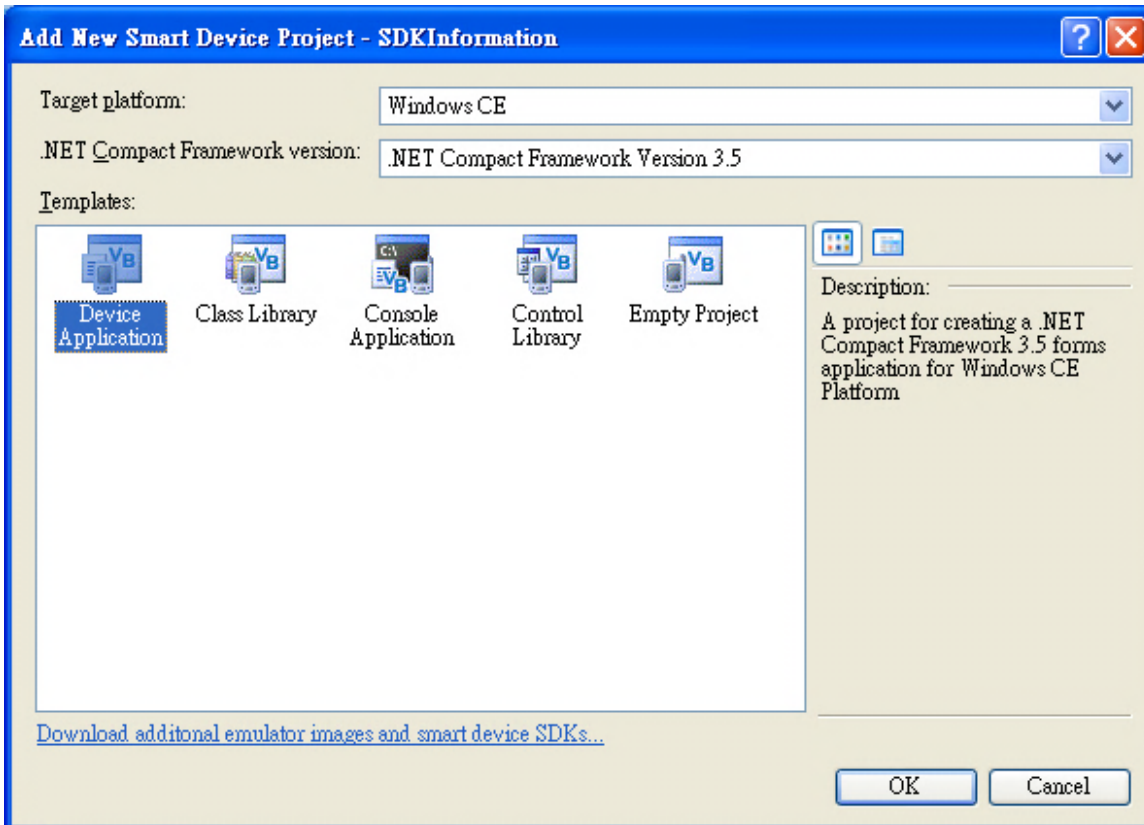

## 4.3.2. Specify the Path of PAC Reference

The PAC SDK provides a complete solution to integrate with WP-5231 and it's compatible with Visual C#, Visual Basic .net and C++. In order to use a component in your application, you must first add a reference to it.

### Step1: Get the PACNET.dll and copy it to the project folder

The PACNET.dll can be obtained from the link below that has been provided on the CD or by downloading the latest version from ICP DAS web site.

CD:\wp-5231\SDK\PACNET\

[http://ftp.icpdas.com/pub/cd/winpac\\_am335x/wp-5231/sdk/pacnet/](http://ftp.icpdas.com/pub/cd/winpac_am335x/wp-5231/sdk/pacnet/)



**Step 2: In Solution Explorer, right-click the References node, and then click Add Reference...**

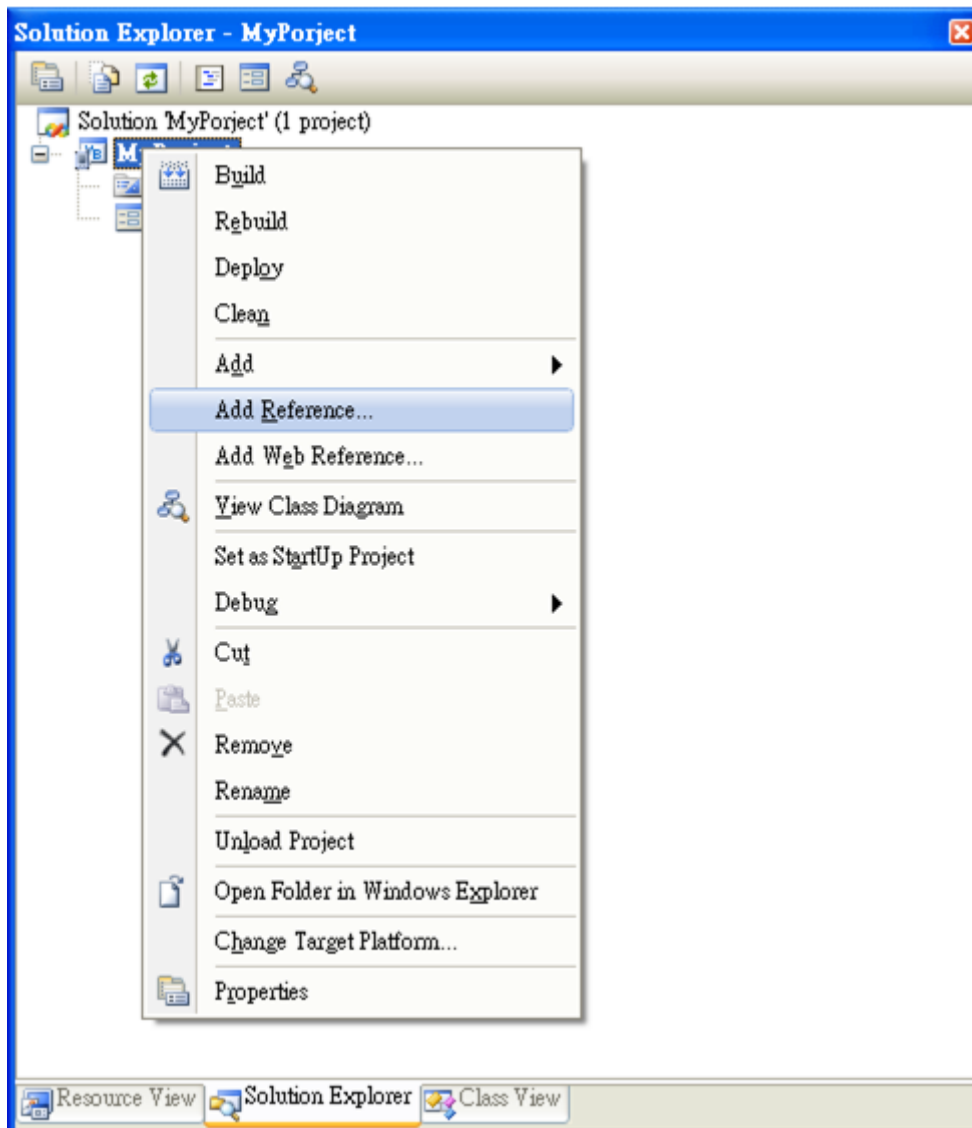



**Step 3: Select Browse tab and add the PACNET.dll**

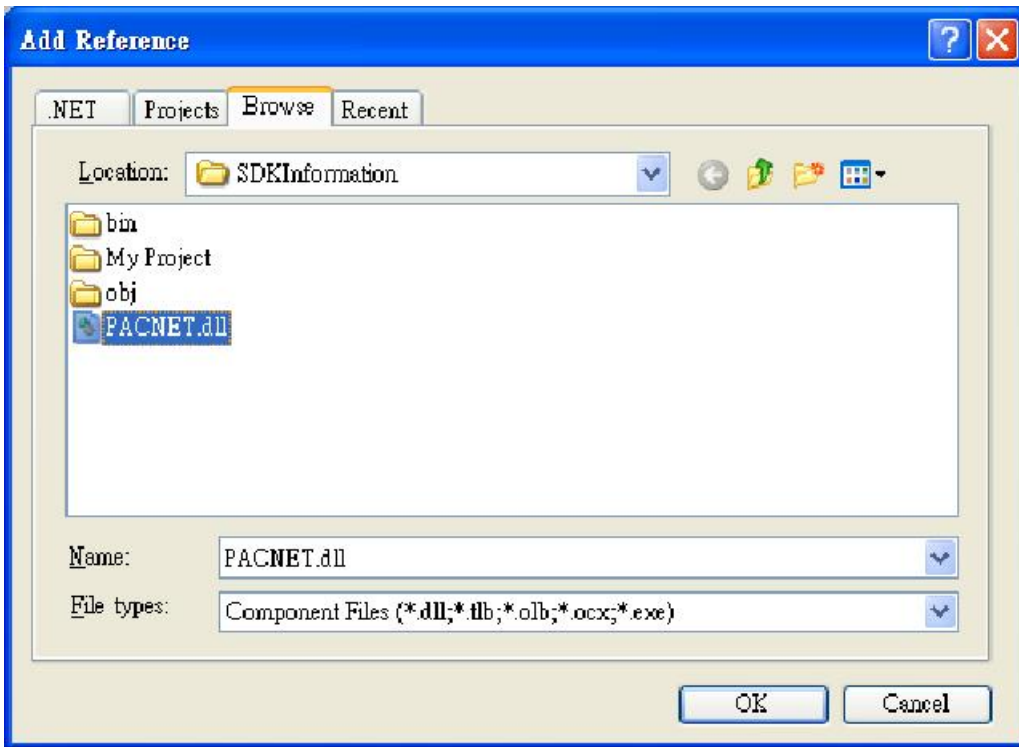

### 4.3.3. Add the Control to the Form

You can drag various controls from the Toolbox onto the form. These controls are not really "live"; they are just images that are convenient to move around on the form into a precise location.

After you add a control to your form, you can use the Properties window to set its properties, such as background color and default text. The values that you specify in the Properties window are the initial values that will be assigned to that property when the control is created at run time.

#### Step 1: From the Toolbox, drag a Button control onto the form

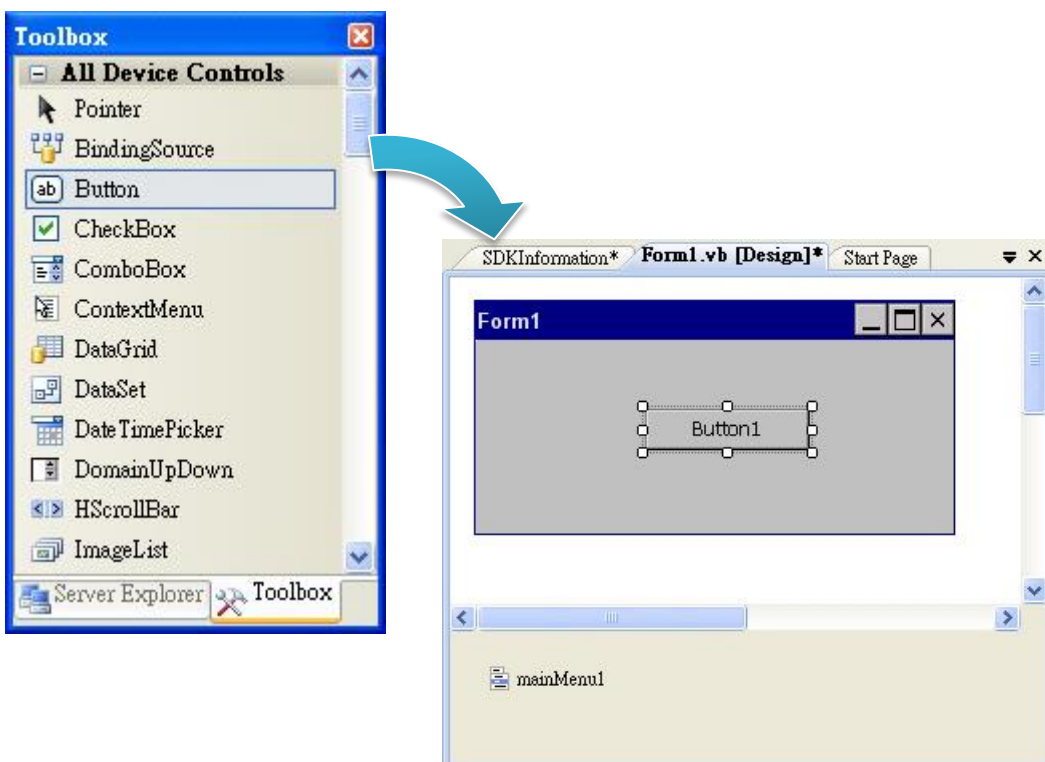

**Step 2: Right-click the Button control, and then click Properties**

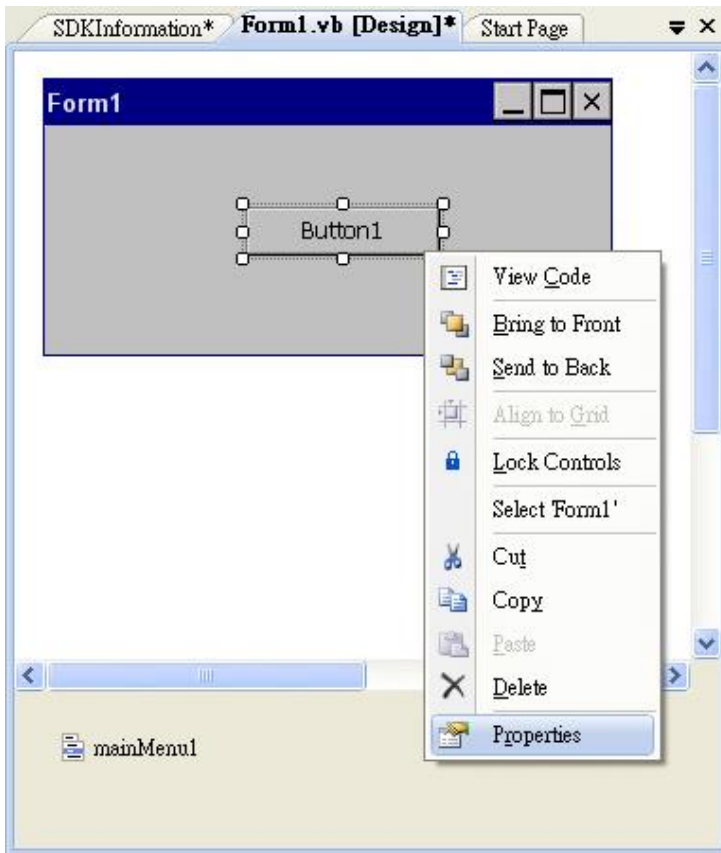

**Step 3: In the Properties window, type Check the SDK version, and press ENTER to set the Text property**

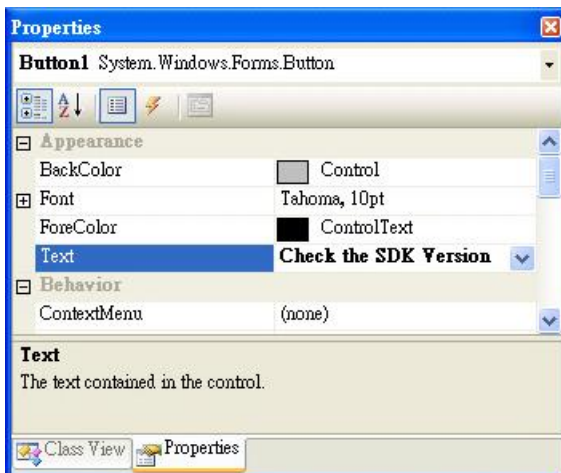

## 4.3.4. Add the Event Handling for the Control

You have finished the design stage of your application and are at the point when you can start adding some code to provide the program's functionality.

### Step 1: Double-click the button on the form

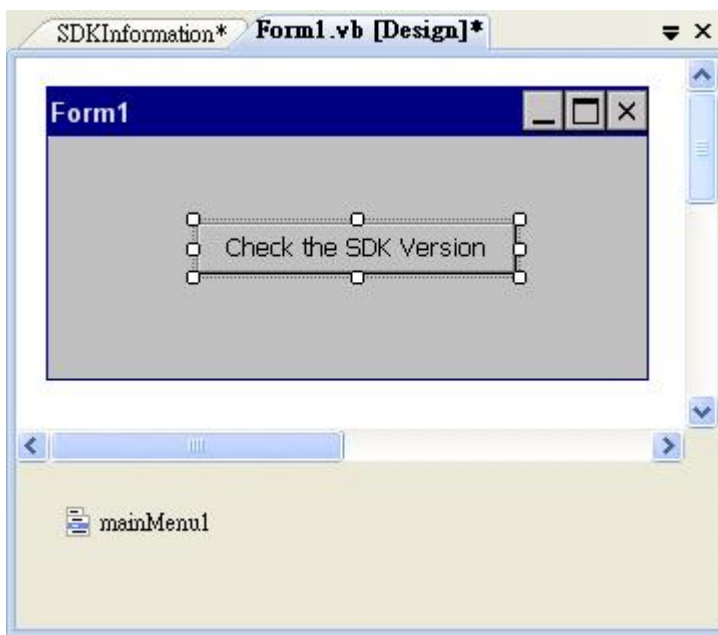

## Step 2: Inserting the following code

```
Dim data(30) As Byte
PACNET.Sys.GetSDKVersion(data)
MessageBox.Show(PACNET.MISC.WideString(data))
```

```
Public Class Form1
    Private Sub Button1_Click(ByVal sender As System.Object, ByVal e As System.EventArgs) Handles Button1.Click
        Dim data(30) As Byte
        PACNET.System.GetSDKVersion(data)
        MessageBox.Show(PACNET.MISC.WideString(data))
    End Sub
End Class
```

---

## Tips & Warnings

---



The “PACNET” of “using PACNET” is case- sensitive.

---

### 4.3.5. Upload the Application to WinPAC

WinPAC supports FTP server service. You can upload files to WinPAC or download files from a public FTP server.

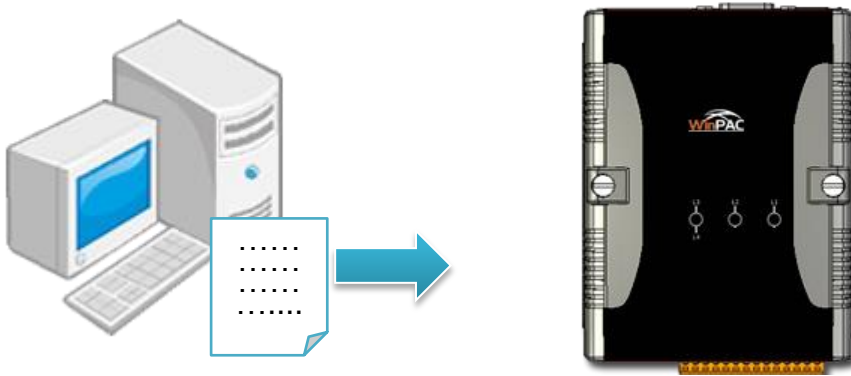

**Step 1: On the Build menu, click Build SDKInformation**

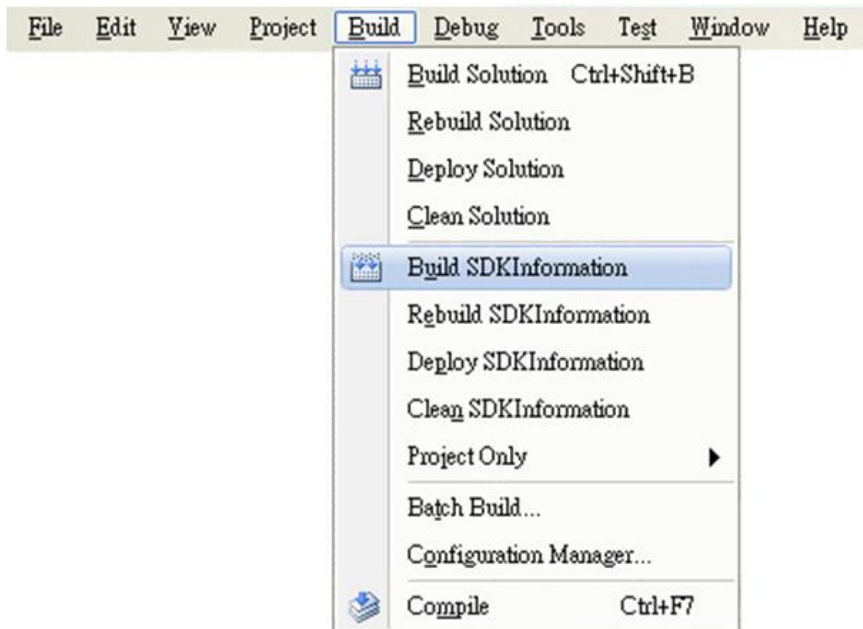

**Step 2: Open the browser and type the IP address of WinPAC**

**Step 3: Upload the SDKInformation.exe application and the corresponding PACSDK.dll and PACNET.dll files to WinPAC**

### Tips & Warnings

---



For applications programming in C# and VB.net with .net compact framework, when executing these application on WinPAC, the corresponding PACSDK.dll and PACNET.dll must be in the same directory as the .exe file.

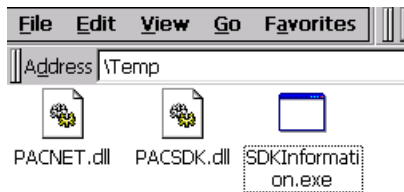

## 4.3.6. Execute the Application on WinPAC

After uploading the application to WinPAC, you can just double-click it on WinPAC to execute it.





## 4.4. First WinPAC Program in Visual C#

The best way to learn programming with WinPAC is to actually create a WinPAC program.

The example below demonstrates how to create a demo program running on WinPAC with C#.

To create a demo program with C# that includes the following main steps:

1. Create a new project
2. Specify the path of the PAC reference
3. Add the control to the form
4. Add the event handling for the control
5. Upload the application to WinPAC
6. Execute the application on WinPAC

All main steps will be described in the following subsection.

## 4.4.1. Create a New Project

The C# project template is a composite control that you use in this example creates a new project with this user control.

### Step 1: Run the Visual Studio 2008

Visual Studio 2008



### Step 2: On the File menu, point to New, and then click Project

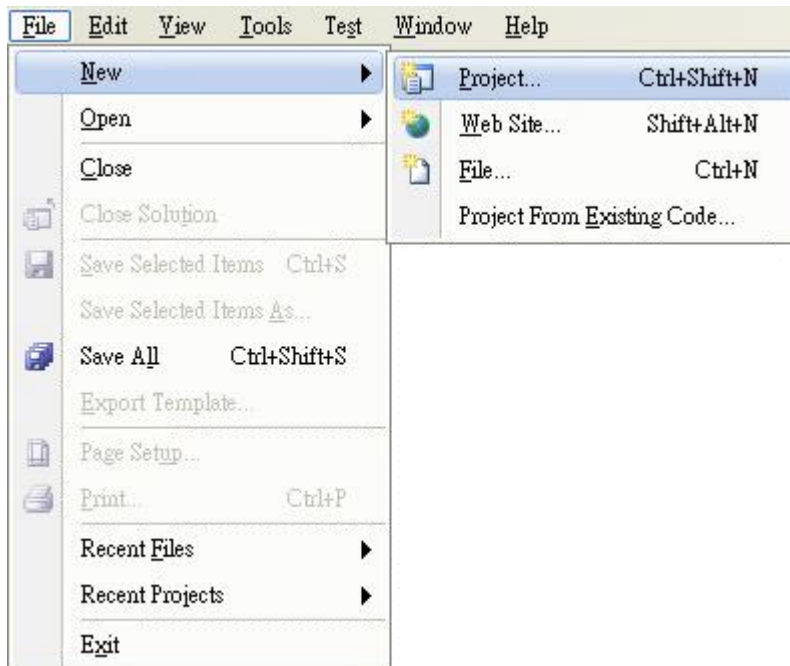

**Step 3: In the Project types pane, expand Visual C#, and then click Smart Device**

**Step 4: In the Templates pane, click Smart Device**

**Step 5: Type a name in the Name field, and then click OK**

Here we will enter the name “SDKInformation” and a different location for the project if you wish.

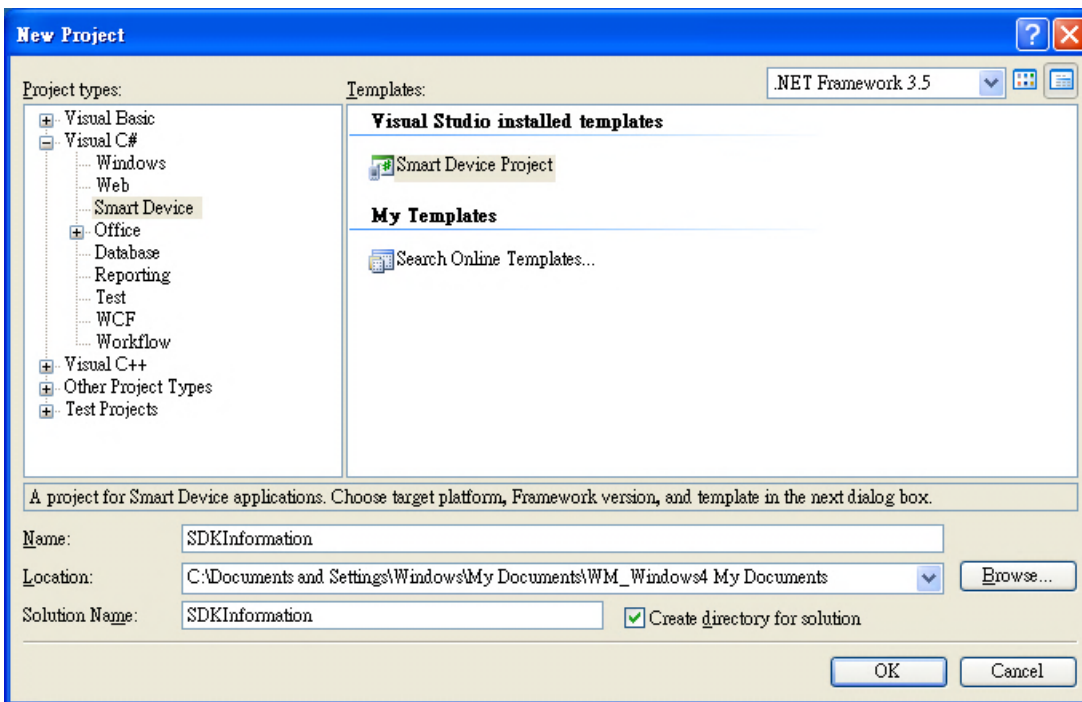

**Step 6: In the Target platform item, choose Windows CE**

**Step 7: in the .NET Compact Formwork version item, choose .NET Compact Framework Version 3.5**

**Step 8: in the Templates pane, choose Device Application, and then click Next**

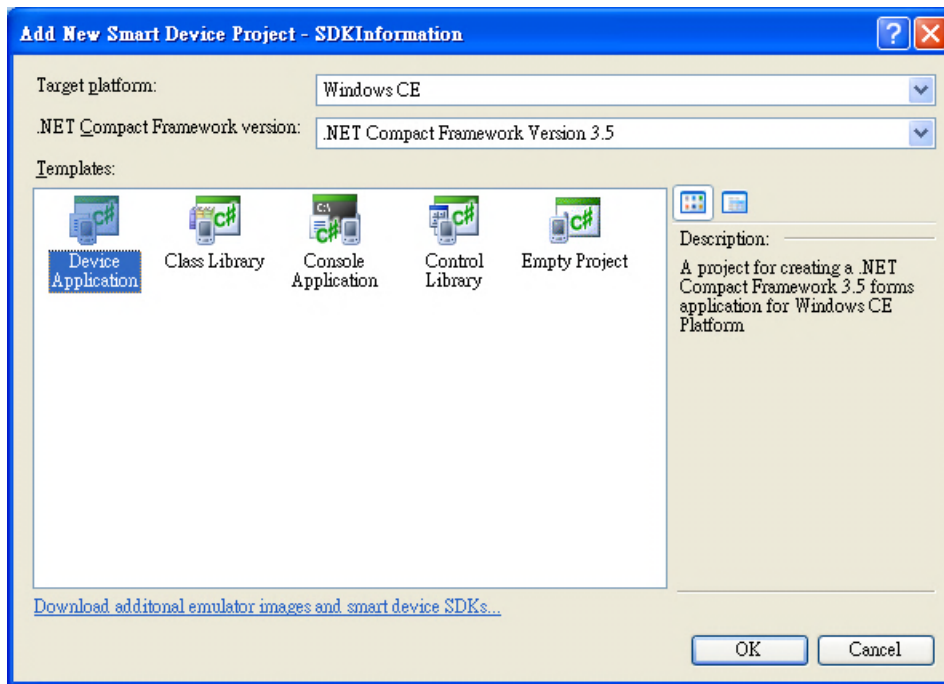

## Tips & Warnings



The WCE7 only support .NET Compact Framework Version 3.5, if your application uses .NET Compact Framework Version 2.0 there is no guarantee that the program will function correctly.

## 4.4.2. Specify the Path of PAC Reference

The PAC SDK provides a complete solution to integrate with WP-5231 and it's compatible with Visual C#, Visual Basic .net and C++. In order to use a component in your application, you must first add a reference to it.

### Step1: Get the PACNET.dll and copy it to the project folder

The PACNET.dll can be obtained from the link below that has been provided on the CD or by downloading the latest version from ICP DAS web site.

CD:\wp-5231\SDK\PACNET\

[http://ftp.icpdas.com/pub/cd/winpac\\_am335x/wp-5231/sdk/pacnet/](http://ftp.icpdas.com/pub/cd/winpac_am335x/wp-5231/sdk/pacnet/)



**Step 2: In Solution Explorer, right-click the References node, and then click Add Reference...**

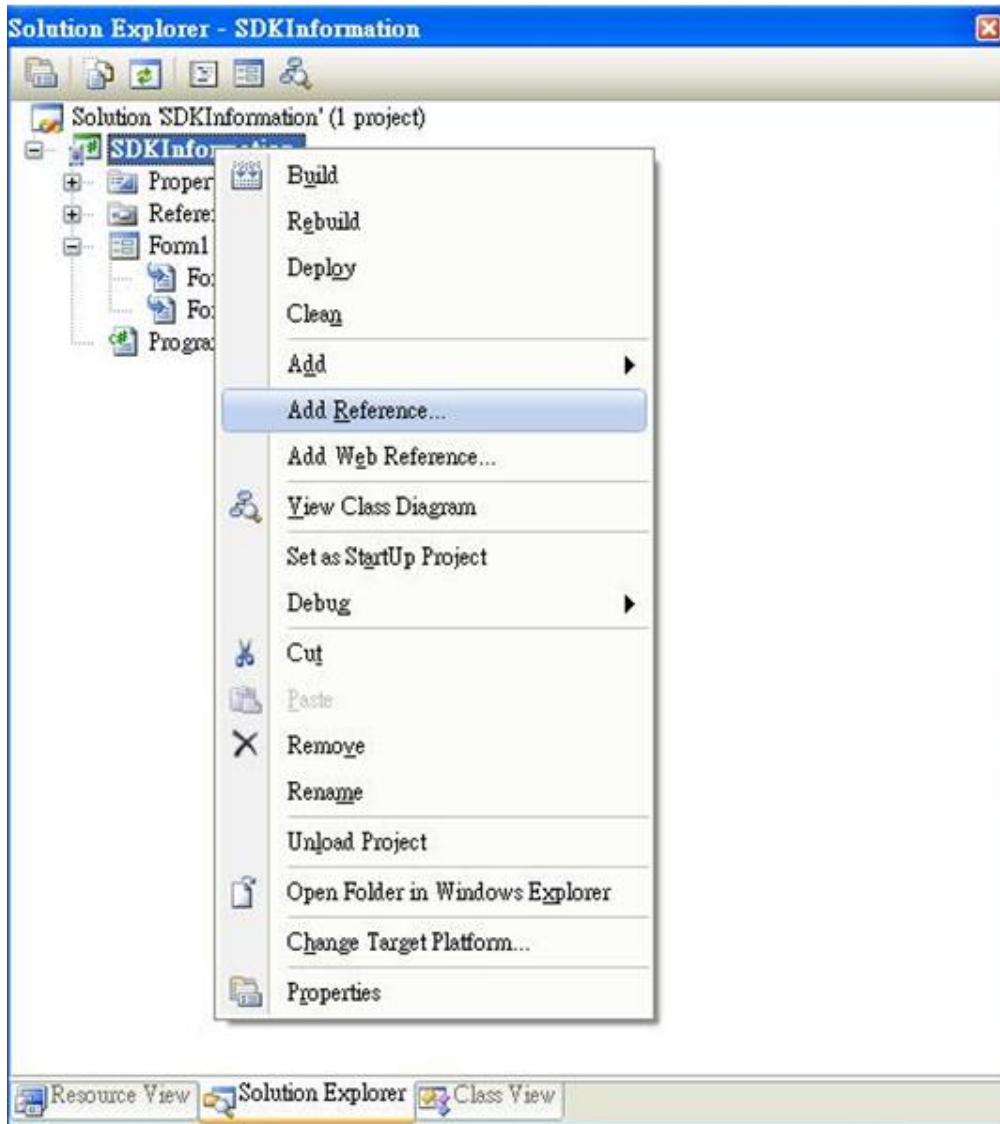

**Step 3: Select Browse tab and add the PACNET.dll**

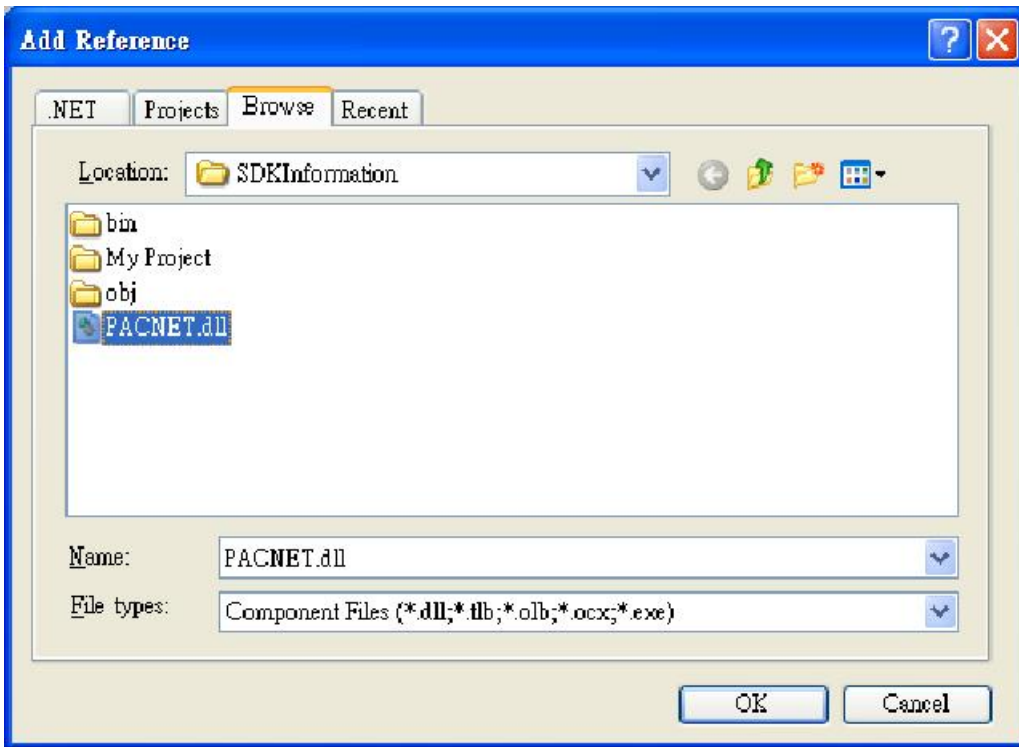

### 4.4.3. Add the Control to the Form

You can drag various controls from the Toolbox onto the form. These controls are not really "live"; they are just images that are convenient to move around on the form into a precise location.

After you add a control to your form, you can use the Properties window to set its properties, such as background color and default text. The values that you specify in the Properties window are the initial values that will be assigned to that property when the control is created at run time.

#### Step 1: From the Toolbox, drag a Button control onto the form

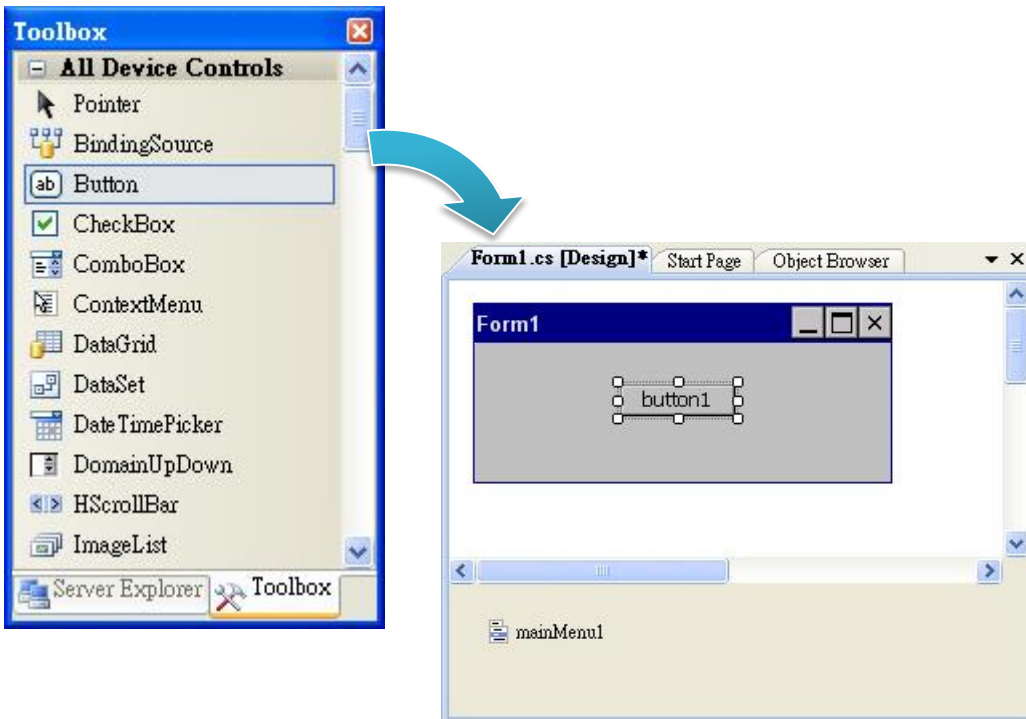



**Step 2: Right-click the Button control, and then click Properties**

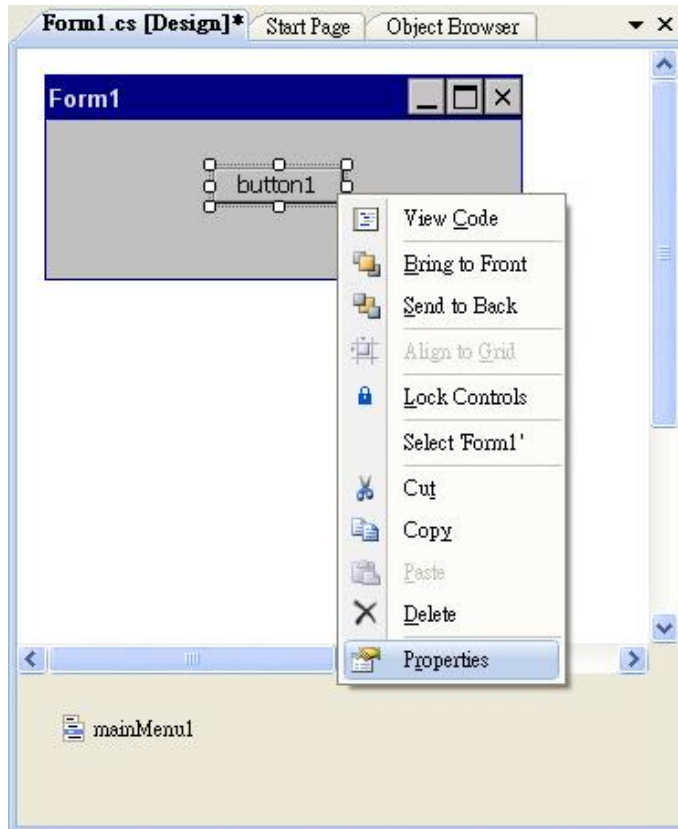

**Step 3: In the Properties window, type Check the SDK version, and press ENTER to set the Text property**

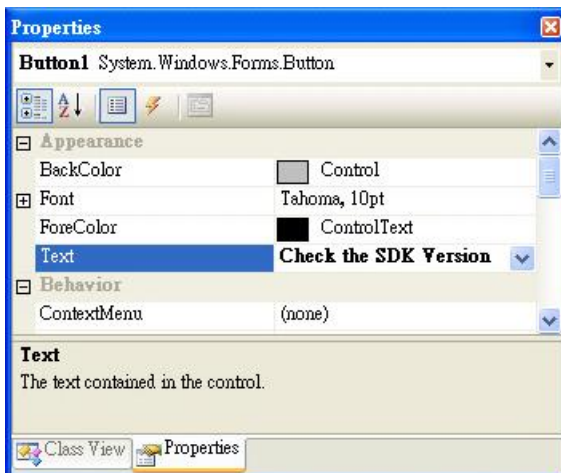

## 4.4.4. Add the Event Handling for the Control

You have finished the design stage of your application and are at the point when you can start adding some code to provide the program's functionality.

### Step 1: Double-click the button on the form

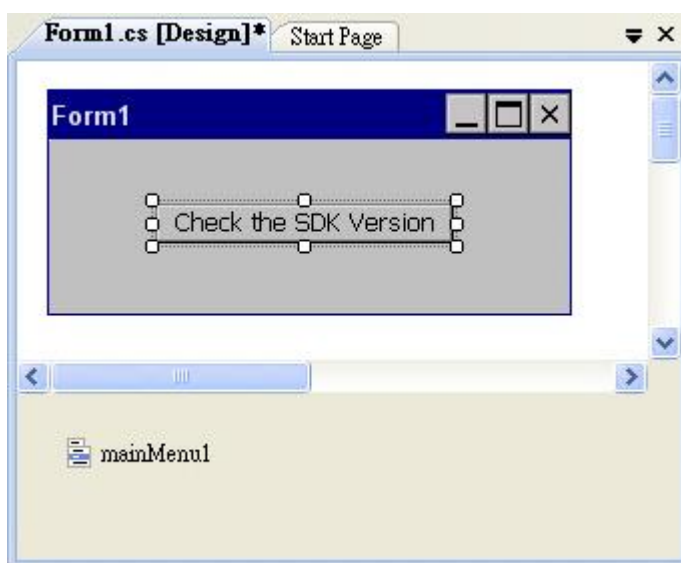

## Step 2: Inserting the following code

```
byte []data = new byte[30];
PACNET.Sys.GetSDKVersion(data);
MessageBox.Show(PACNET.MISC.WideString(data));
```

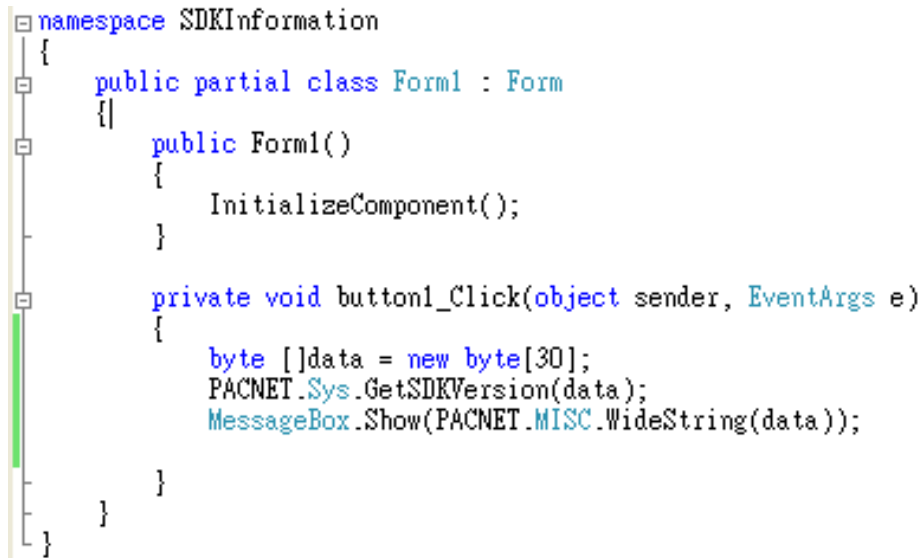

```
namespace SDKInformation
{
    public partial class Form1 : Form
    {
        public Form1()
        {
            InitializeComponent();
        }

        private void button1_Click(object sender, EventArgs e)
        {
            byte []data = new byte[30];
            PACNET.Sys.GetSDKVersion(data);
            MessageBox.Show(PACNET.MISC.WideString(data));
        }
    }
}
```

## 4.4.5. Upload the Application to WinPAC

WinPAC supports FTP server service. You can upload files to WinPAC or download files from a public FTP server.

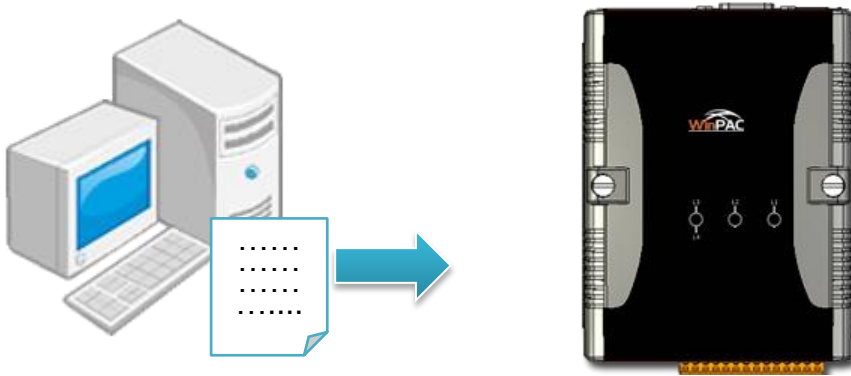

### Step 1: On the Build menu, click Build SDKInformation

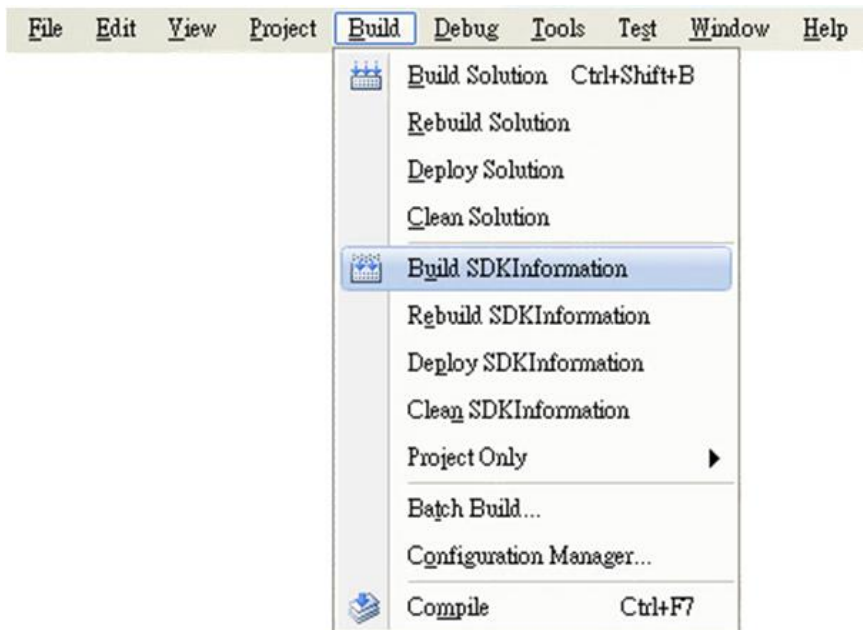

**Step 2: Open the browser and type the IP address of WinPAC**

**Step 3: Upload the SDKInformation.exe application and the corresponding PACSDK.dll and PACNET.dll files to WinPAC**

### Tips & Warnings

---



For applications programming in C# and VB.net with .net compact framework, when executing these application on WinPAC, the corresponding PACSDK.dll and PACNET.dll must be in the same directory as the .exe file.

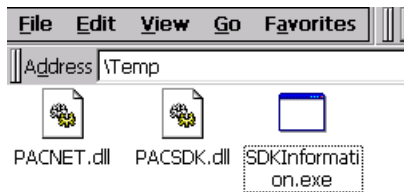

## 4.4.6. Execute the Application on WinPAC

After uploading the application to WinPAC, you can just double-click it on WinPAC to execute it.



## 4.5. First WinPAC Program in Visual C++

The best way to learn programming with WinPAC is to actually create a WinPAC program.

The example below demonstrates how to create a demo program running on WinPAC with Visual C++

To create a demo program with Visual C++ that includes the following main steps:

1. Create a new project
2. Configure the platform
3. Specify the path of the PAC reference
4. Add the control to the form
5. Add the event handling for the control
6. Upload the application to WinPAC
7. Execute the application on WinPAC

All main steps will be described in the following subsection.

### Tips & Warnings

---



Before beginning a new project, the “Embedded Compact 7 ATL Update” must be installed. If this update is not installed, the error message “atlconv.h error C2039: IstrlenW” will be displayed after the program is compiled.

The update can be found on the CD that was provided with the package or by downloading the latest version from Microsoft.

CD:\wp-5231\SDK\VisualStudioDeviceWindowsEmbeddedCompact7.msi

<http://download.microsoft.com/download/9/D/D/9DDBD3EC-A43C-4BCE-A7A9-AEE9B1007BCE/VisualStudioDeviceWindowsEmbeddedCompact7.msi>

---

## 4.5.1. Create a New Project

The Visual C++ project template is a composite control that you use in this example creates a new project with this user control.

### Step 1: Run the Visual Studio 2008

Visual Studio 2008



### Step 2: On the File menu, point to New, and then click Project

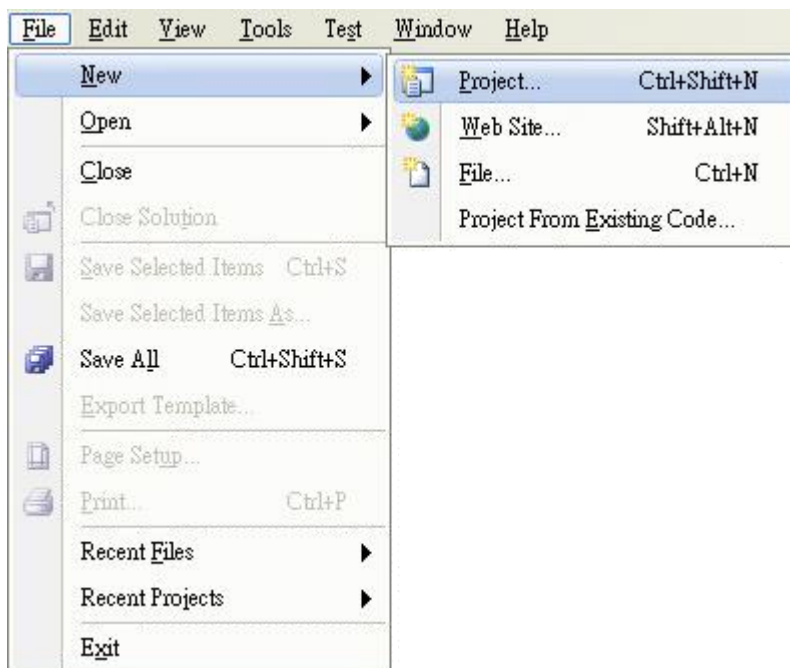



**Step 3: In the Project types pane, expand Visual C++, and then click Smart Device**

**Step 4: In the Templates pane, click MFC Smart Device Application**

**Step 5: Type a name in the Name field, and then click OK**

Here we will enter the name “SDKInformation” and a different location for the project if you wish

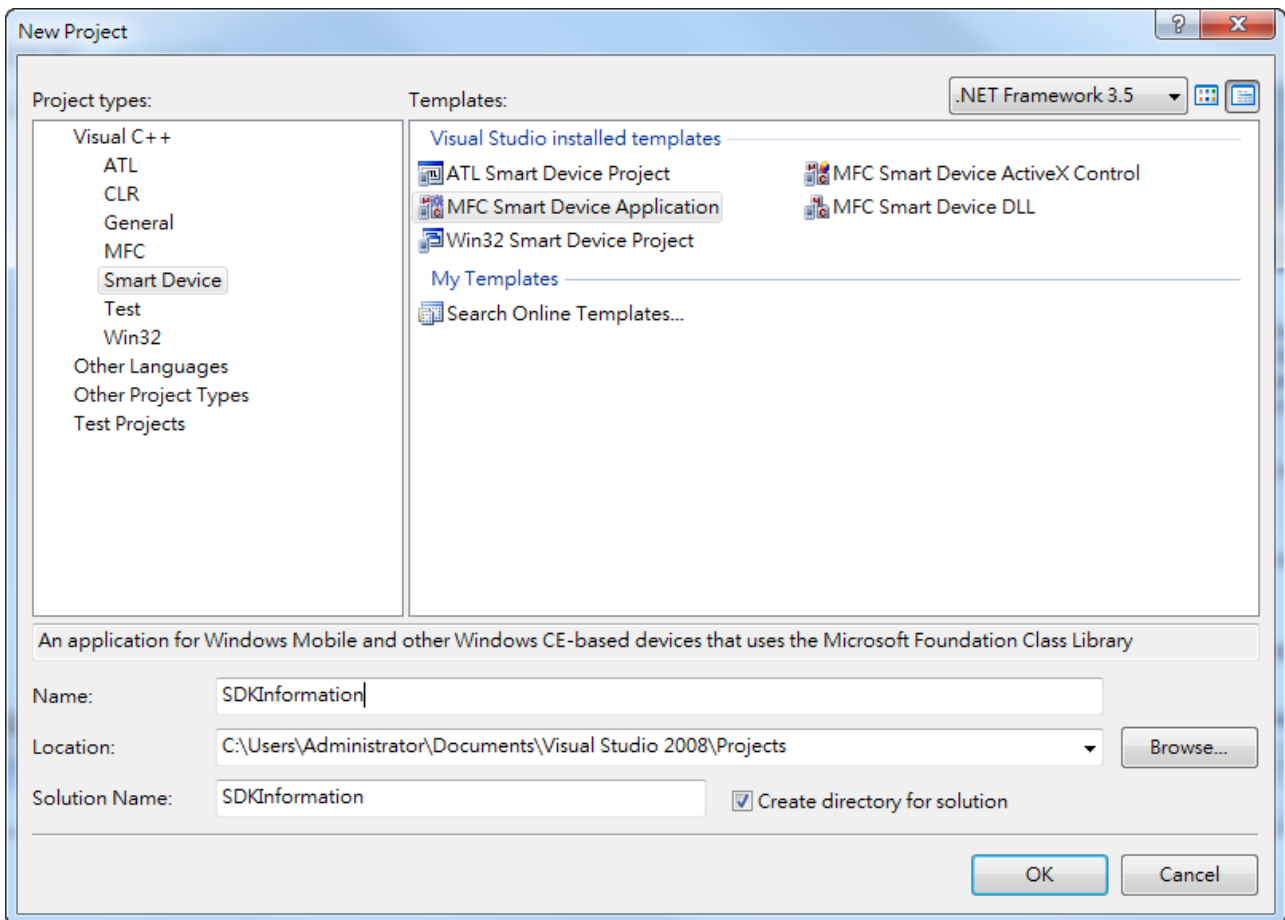

**Step 6: On the first page of the wizard, click Next**

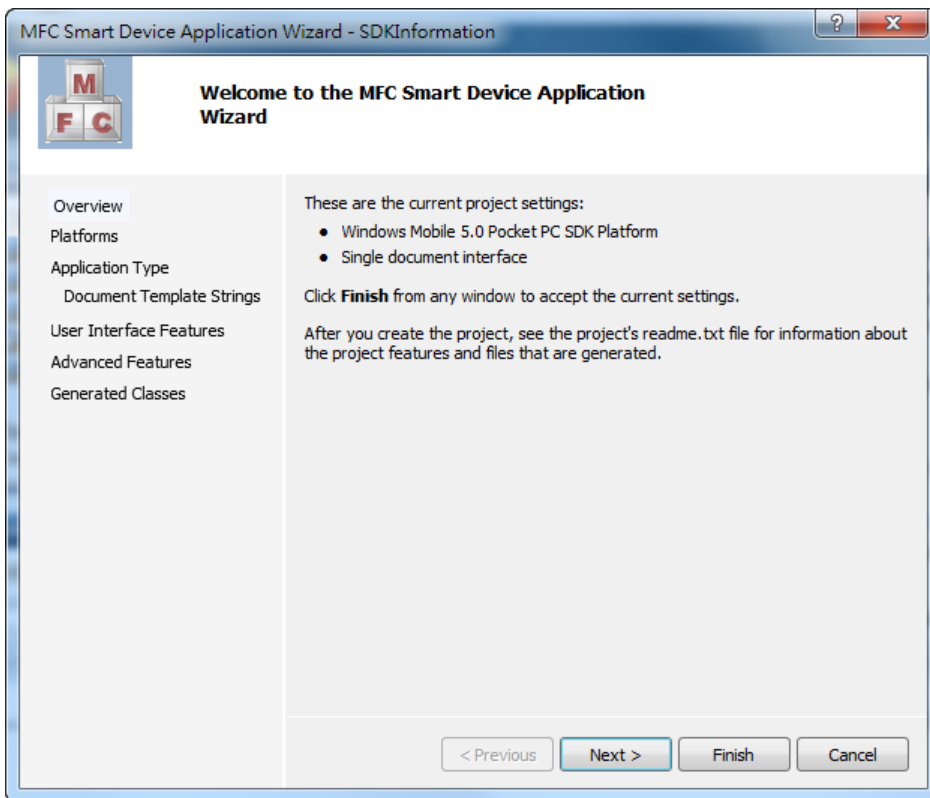

**Step 7: On the next page of the wizard, select AM335x\_WINCE7\_SDK to be added to the project, and then click Next**

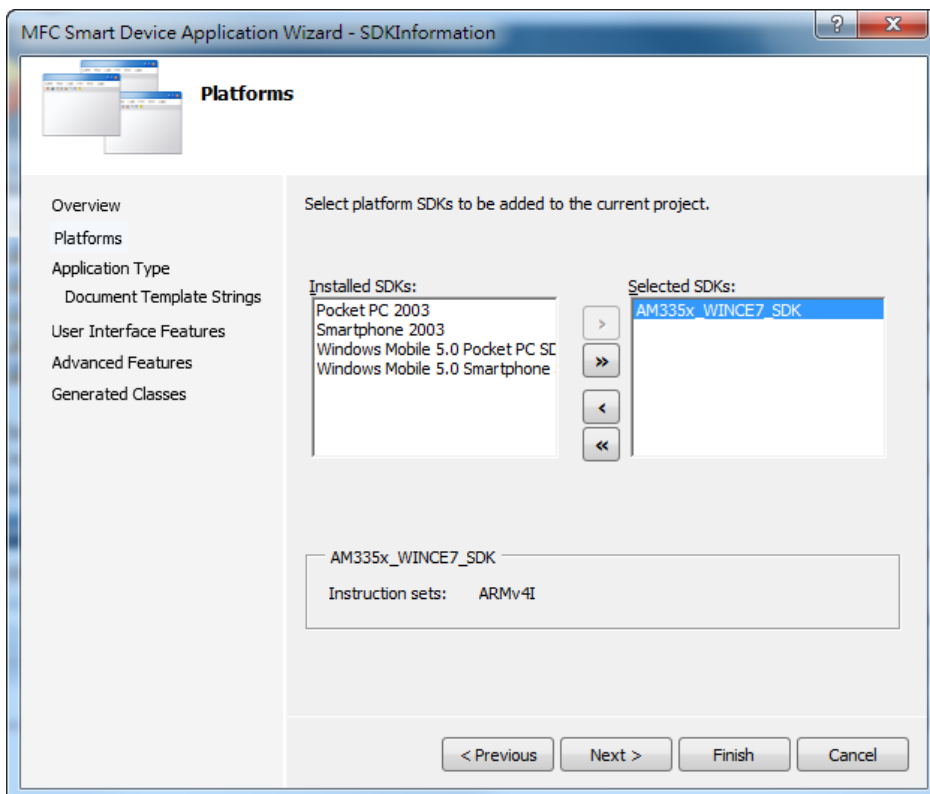

**Step 8: On the next page of the wizard, select Dialog based, and then click next**

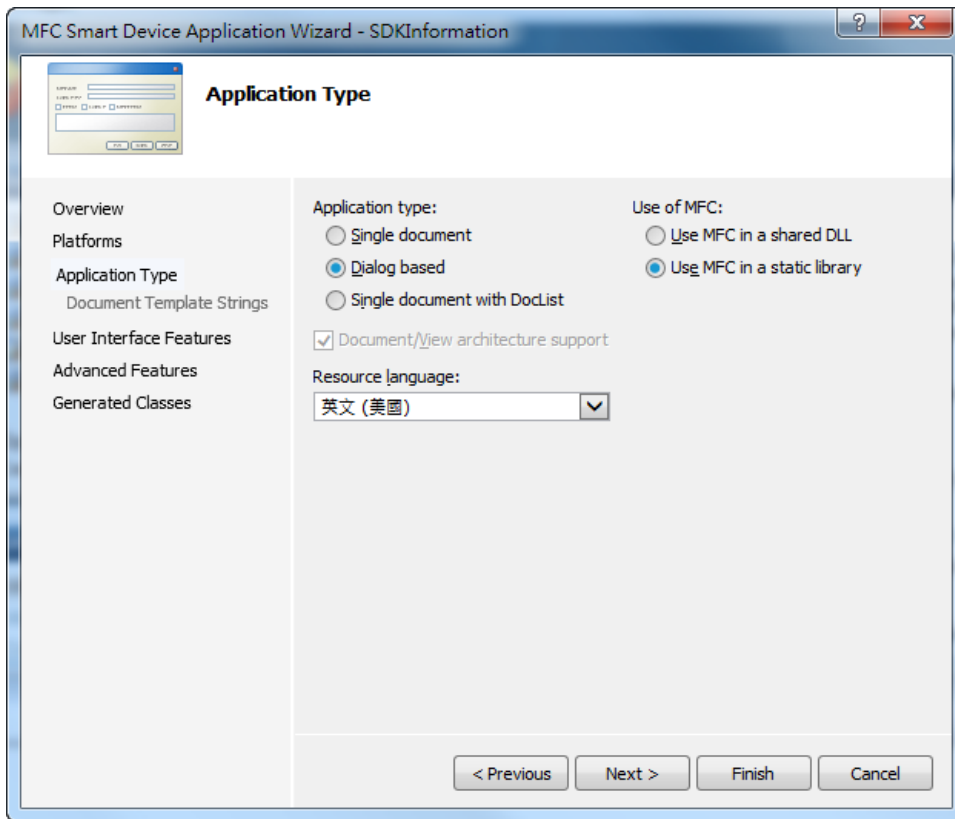

**Step 9: On the next page of the wizard, click next**

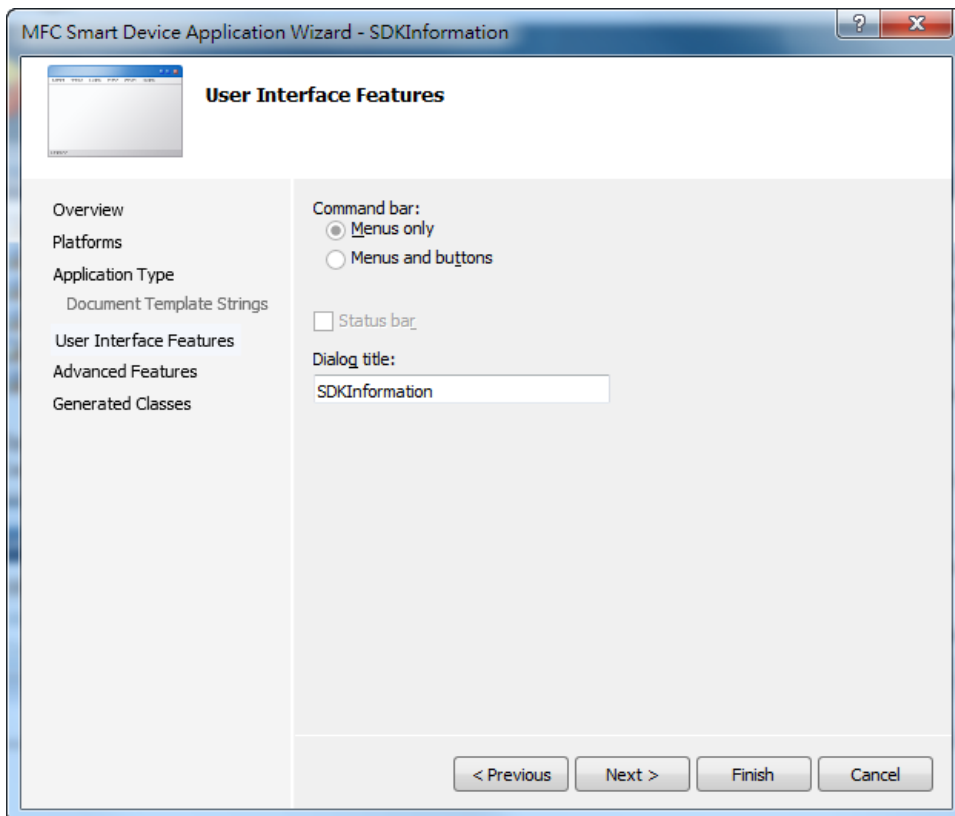

**Step 10: On the next page of the wizard, click next**

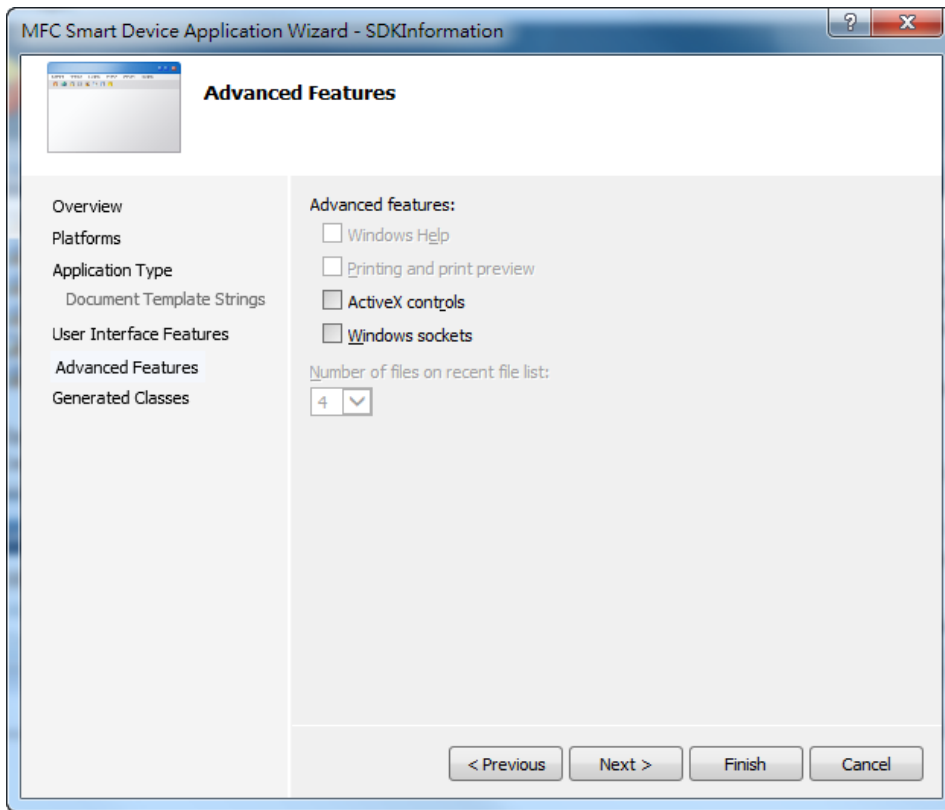

**Step 11: On the next page of the wizard, click Finish**

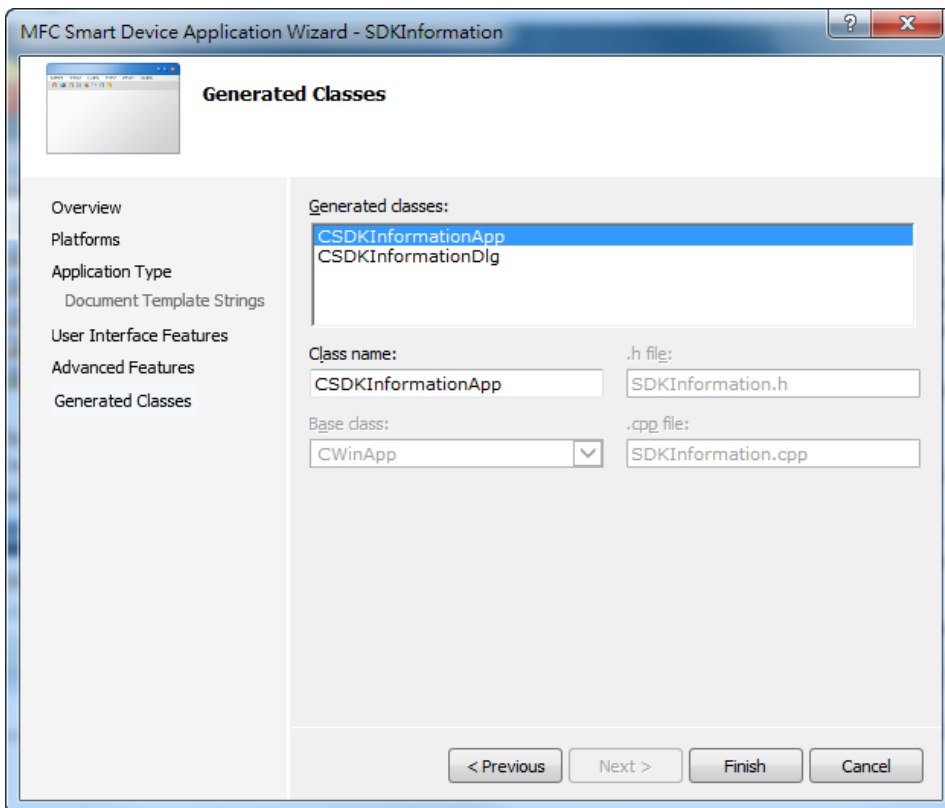

## 4.5.2. Configure the Platform

When developing applications by using Visual C++, you must configure the Platform to indicate what platform and device you intend to download the application to. Before you deploy your project, check the platform.

On the Debug configuration toolbar, select Release, and then on the AM335x\_WINCE7\_SDK (ARMV4) configuration toolbar, select AM335x\_WINCE7\_SDK (ARMV4), as shown in the following illustration.

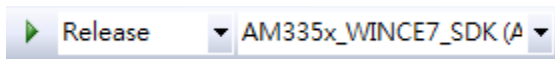

### 4.5.3. Specify the Path of the PAC Reference

The PAC SDK provides a complete solution to integrate with WP-5231 and it's compatible with Visual C#, Visual Basic .net and C++. In order to use a component in your application, you must first add a reference to it.

**Step 1: Right-click the project name, and then click Properties**

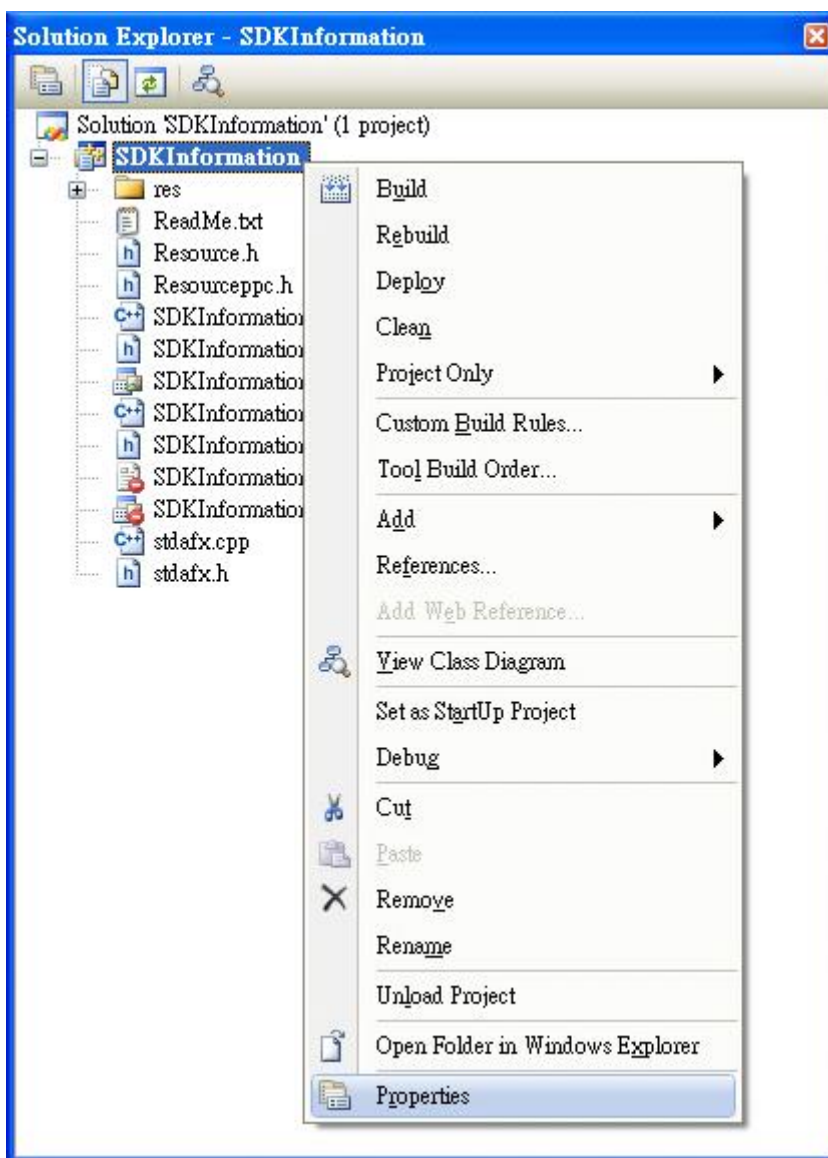

**Step 2: In left pane, expand Configuration Properties, and then click Link**

**Step 3: In the right pane, choose the PACSDK\_CE.lib in the Additional Dependencies item**

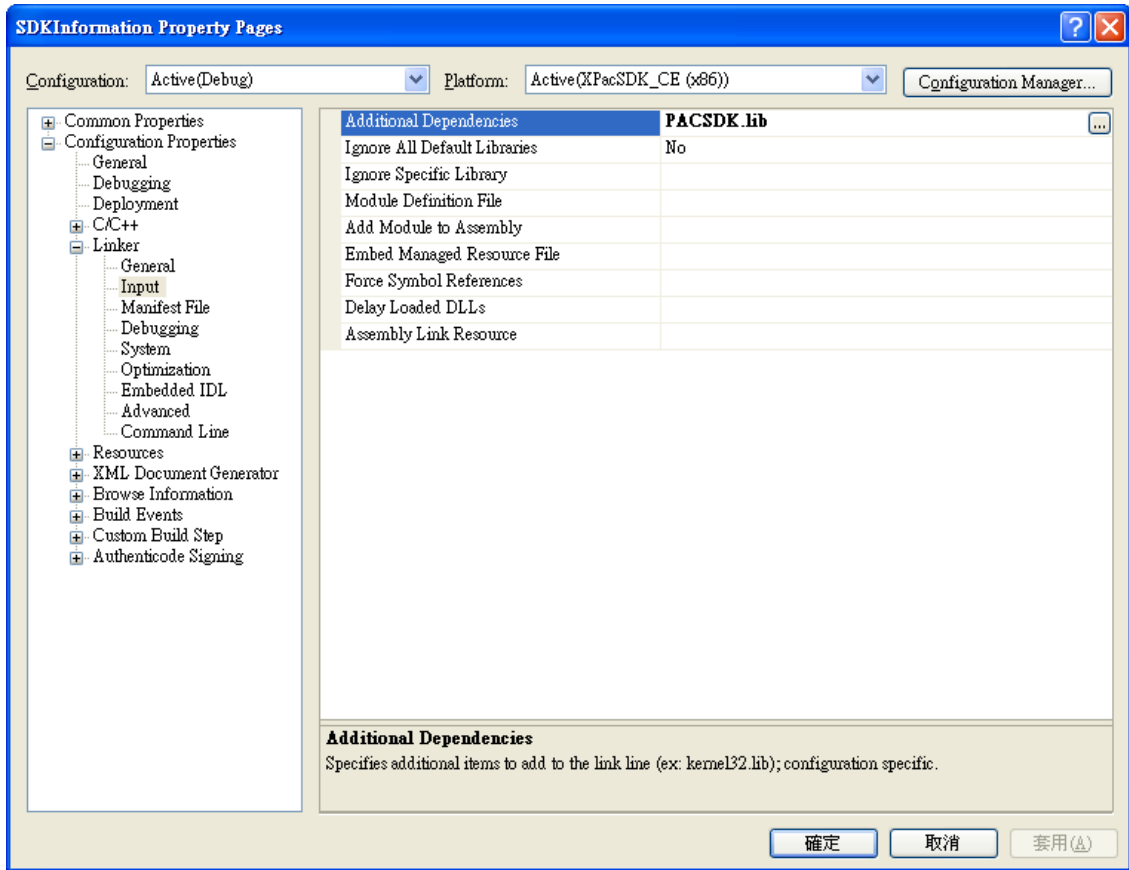

**Step 4: In the right pane, choose the following path in the “Additional Include Directories” item**

C:\Program Files\Windows CE

Tools\SDKs\AM335x\_WINCE7\_SDK\Include\Armv4i

C:\Program Files\Microsoft Visual Studio 9.0\VC\ce7\atlmfc\include

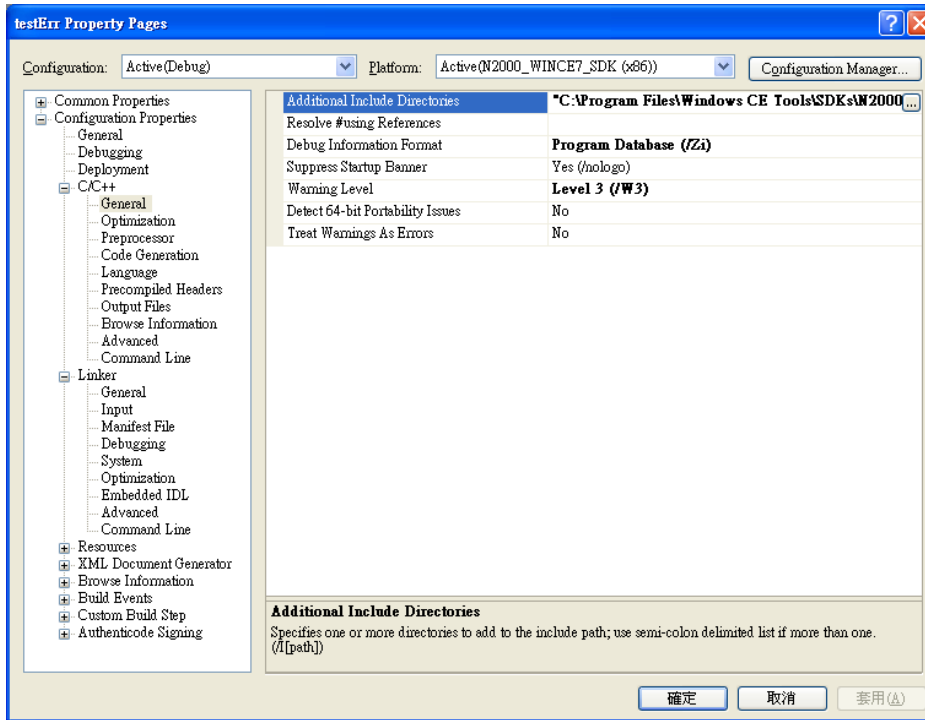



## 4.5.4. Add the Control to the Form

You can drag various controls from the Toolbox onto the form. These controls are not really "live"; they are just images that are convenient to move around on the form into a precise location.

After you add a control to your form, you can use the Properties window to set its properties, such as background color and default text. The values that you specify in the Properties window are the initial values that will be assigned to that property when the control is created at run time.

**Step 1: In Resource View, expand the resources tree by opening the top level folder**

**Step 2: Open the Dialog folder and then double-click the dialog resource name  
IDD\_SDKINFORMATION\_DIALOG**

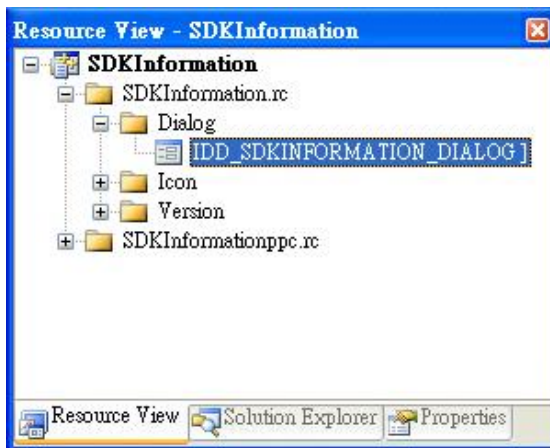

The resource editor appears in the right pane.

**Step 3: From the Toolbox, drag a Button control onto the form**

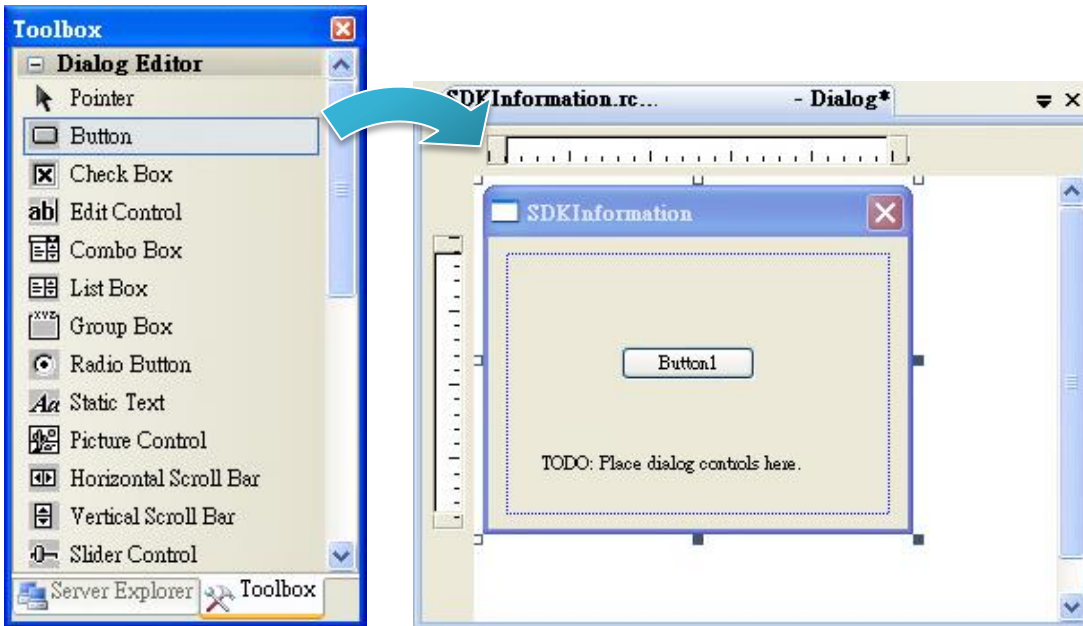

**Step 4: Right-click the Button control, and then click Properties**

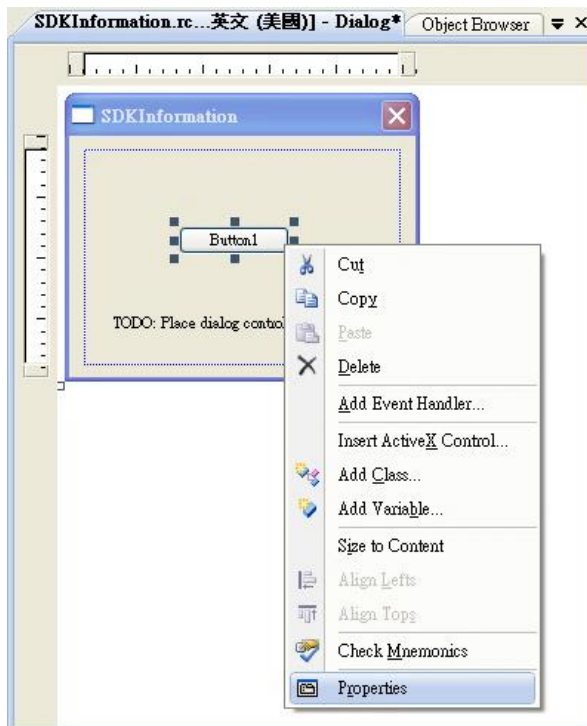

**Step 5: In the Properties window, type Check the SDK version, and press ENTER to set the Text property**

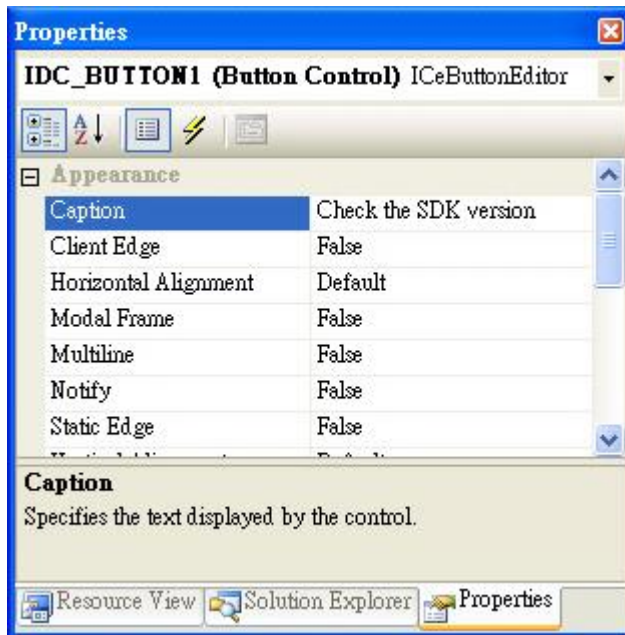

## 4.5.5. Add the Event Handling for the Control

You have finished the design stage of your application and are at the point when you can start adding some code to provide the program's functionality.

### Step 1: Double-click the button on the form

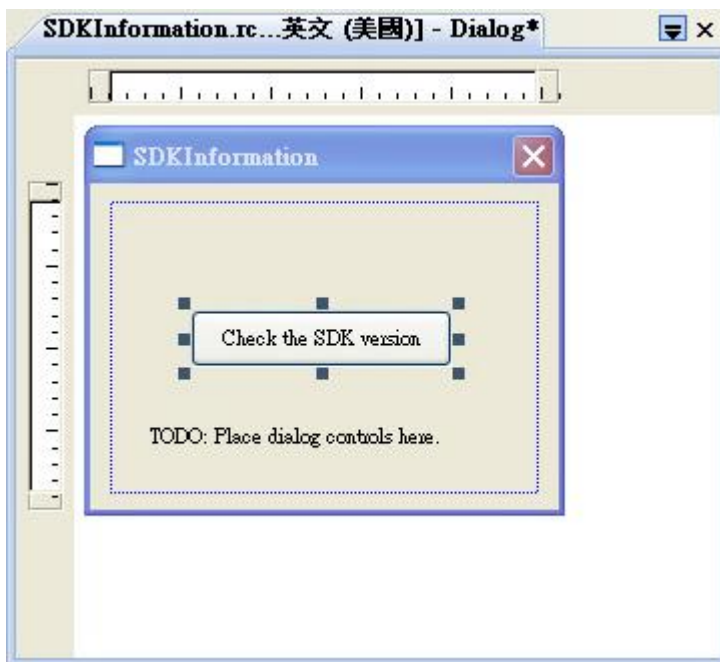

## Step 2: Inserting the following code

```
char sdk_version[32];
TCHAR buf[32];
pac_GetSDKVersion(sdk_version);
pac_AnsiToWideString(sdk_version, buf);
MessageBox(buf,0,MB_OK);
```

```
void CSDKInformationDlg::OnBnClickedButton1()
{
    // TODO: Add your control notification handler code here
    char sdk_version[32];
    TCHAR buf[32];
    pac_GetSDKVersion(sdk_version);
    pac_AnsiToWideString(sdk_version, buf);
    MessageBox(buf,0,MB_OK);
}
```

## Step 3: Inserting the following code into the header area

```
#include "PACSDK.h"
```

```
#include "stdafx.h"
#include "SDKInformation.h"
#include "SDKInformationDlg.h"
#include "PACSDK.H"
```

### 4.5.5.1. Upload the Application to WinPAC

WinPAC supports FTP server service. You can upload files to WinPAC or download files from a public FTP server.

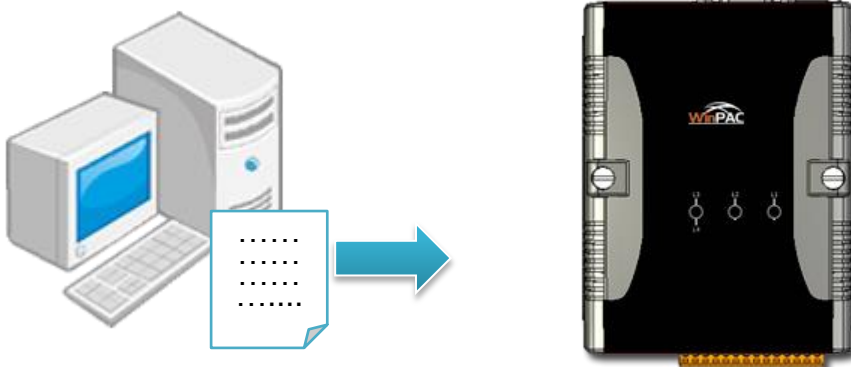

**Step 1: On the Build menu, click Build SDKInformation**

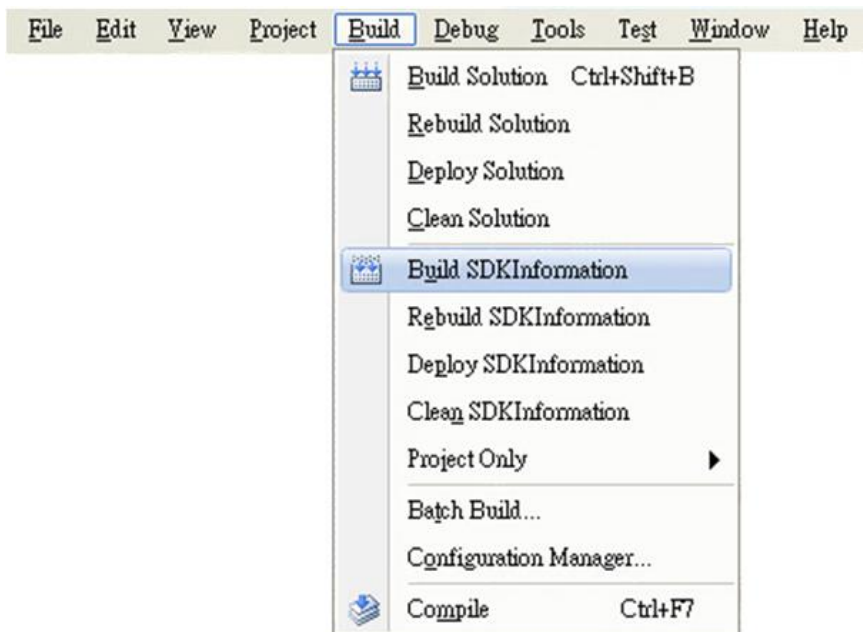

**Step 2: Open the browser and type the IP address of WinPAC**

**Step 3: Upload the SDKInformation.exe application to WinPAC**



### 4.5.5.2. Execute the Application on WinPAC

After uploading the application to WinPAC, you can just double-click it on WinPAC to execute it.





# 5. APIs and Samples

This chapter provides a brief overview of PAC APIs and samples that have been designed for ViewPAC.

ICP DAS provides a set of samples in different programming languages. You can examine the sample codes, which includes numerous comments, to familiarize yourself with the PAC APIs. This will allow developing your own applications quickly by modifying these demo programs.

For full usage information regarding the description, prototype and the arguments of the functions, please refer to the “PAC Standard API Manual”

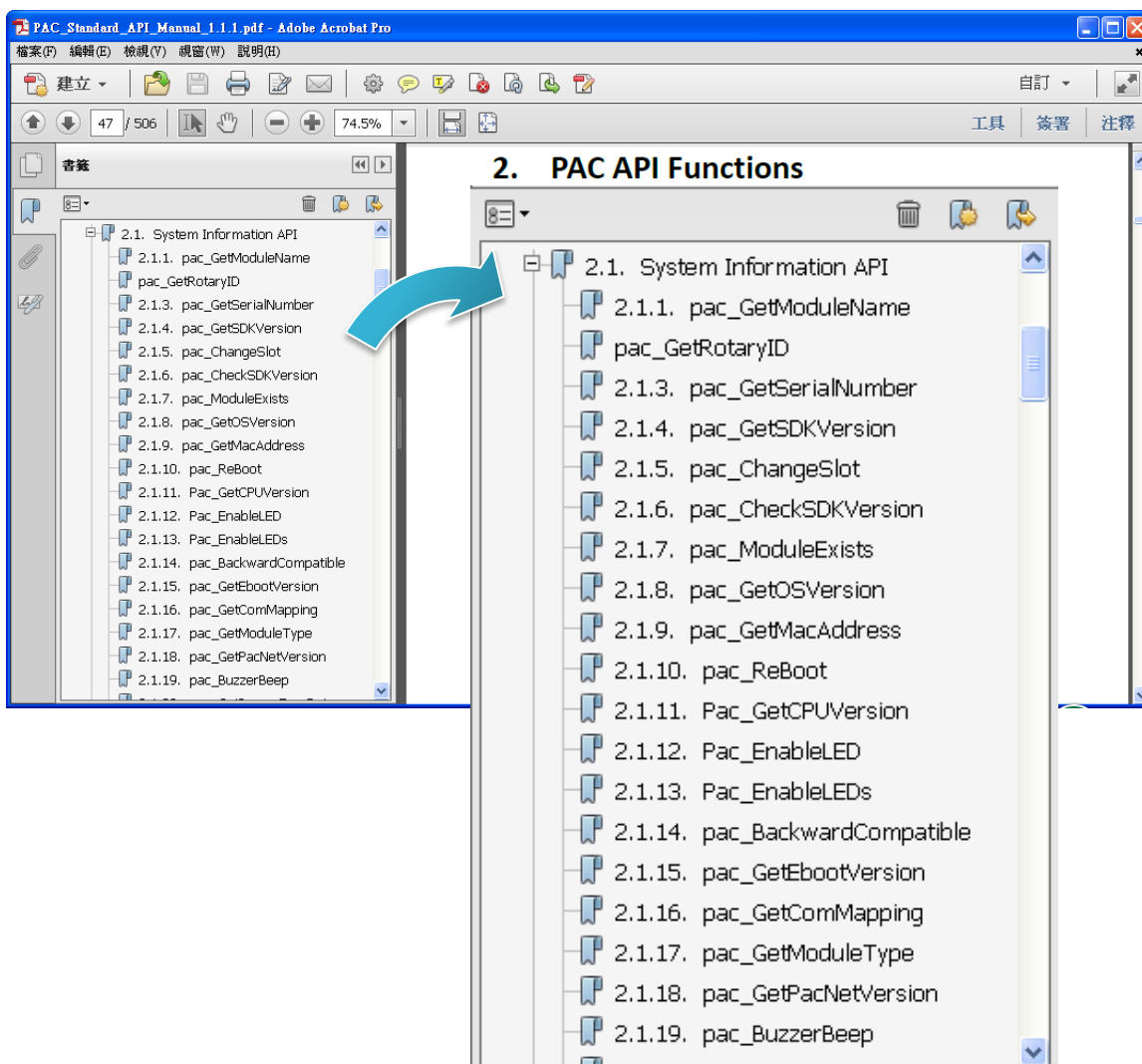

## 5.1. PAC Standard APIs

The diagram below shows the set of each system operation API provided in the PACSDK.

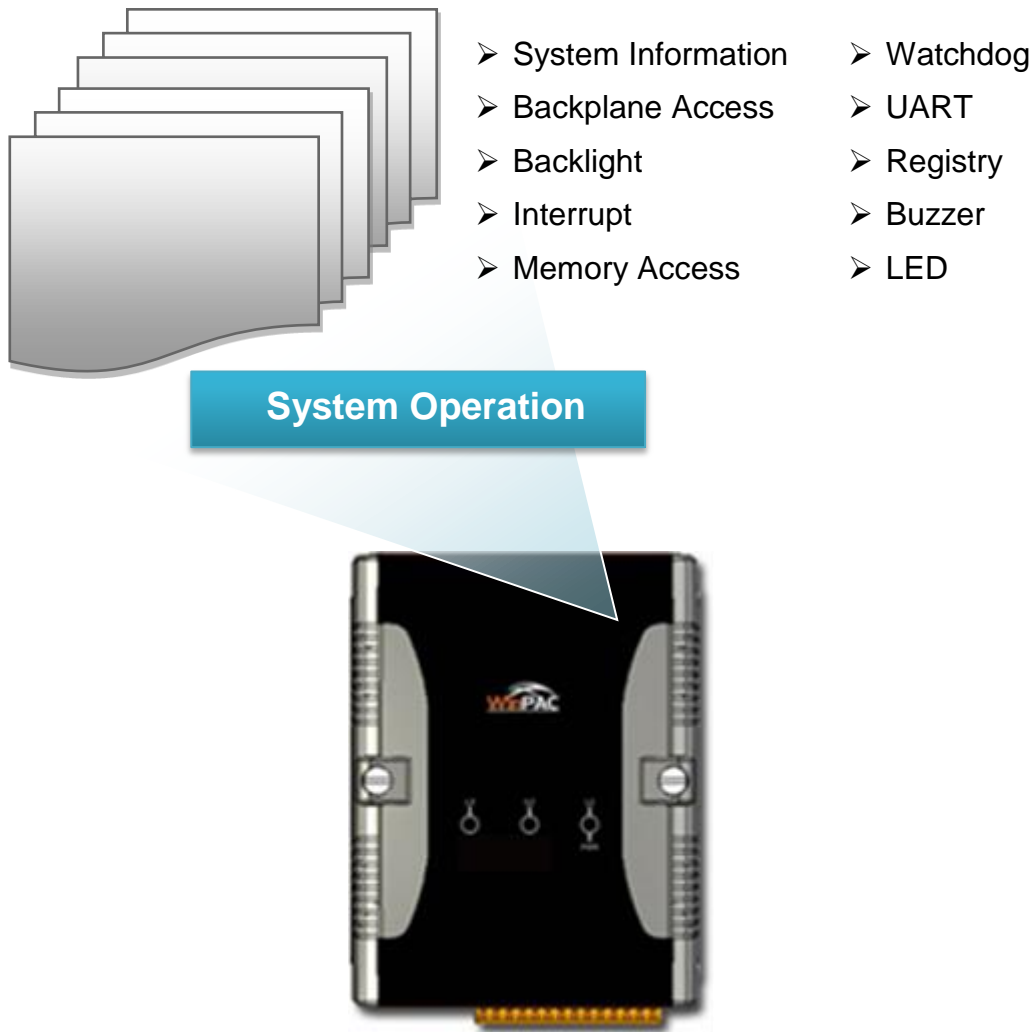

## 5.1.1. VB.NET Samples for PAC Standard APIs

The PAC SDK includes the following samples that demonstrate the use of the PAC Standard APIs in a VB.NET language environment. The following samples can be found on the CD that was provided with the package or by downloading the latest version from ICP DAS web site.

For VB.NET applications, these demo programs can be obtained from:

CD:\wp-5231\Demo\PAC\Vb.net\Standard\

[http://ftp.icpdas.com/pub/cd/winpac\\_am335x/wp-5231/demo/pac/vb.net/standard/](http://ftp.icpdas.com/pub/cd/winpac_am335x/wp-5231/demo/pac/vb.net/standard/)

Folder	Demo	Explanation
buzzer	buzzer	Shows how to make a simple buzzer beep.
DeviceInformation	DeviceInformation	Retrieves information about the OS version, CPU version, SDK version, etc.
GetRotaryID	GetRotaryID	Retrieves information about the status of the rotary switch
Memory	Memory	Shows how to read/write data values from/to the EEPROM or the backplane of the SRAM
MicroSD	MicroSD_Management	Shows how to manage the microSD
RealTimeTest	VB_UI_Call_VC_Realtime	Writes the managed code for the rich graphical user interface that does not require true real-time performance
	VBOonly	Shows how to use the function of JIT compiler and garbage collector
Registry	Registry	Shows how to read/write data values from/to the registry
UART	UART	Shows how to read the name of a local I/O modules via a UART
WatchDog	WatchDog	Displays information about how to operate the watchdog

## 5.1.2. C# Samples for PAC Standard APIs

The PAC SDK includes the following samples that demonstrate the use of the PAC Standard APIs in a C# language environment. The following samples can be found on the CD that was provided with the package or by downloading the latest version from ICP DAS web site.

For C# applications, these demo programs can be obtained from:

CD:\wp-5231\Demo\PAC\C#\Standard\

[http://ftp.icpdas.com/pub/cd/winpac\\_am335x/wp-5231/demo/pac/c%23/standard/](http://ftp.icpdas.com/pub/cd/winpac_am335x/wp-5231/demo/pac/c%23/standard/)

Folder	Demo	Explanation
buzzer	buzzer	Shows how to make a simple buzzer beep.
DeviceInformation	DeviceInformation	Retrieves information about the OS version, CPU version, SDK version, etc.
GetRotaryID	GetRotaryID	Retrieves information about the status of the rotary switch
Memory	Memory	Shows how to read/write data values from/to the EEPROM or the backplane of the SRAM
MicroSD	MicroSD_Management	Shows how to manage the microSD
RealTimeTest	CSharp_UI_call_VC_Realtime	Writes the managed code for the rich graphical user interface that does not require true real-time performance
	CSharpOnly	Shows how to use the function of JIT compiler and garbage collector
Registry	Registry	Shows how to read/write data values from/to the registry
UART	UART	Shows how to read the name of a local I/O module via a UART
WatchDog	WatchDog	Displays information about how to operate the watchdog

### 5.1.3. Visual C++ Samples for PAC Standard APIs

The PAC SDK includes the following samples that demonstrate the use of the PAC Standard APIs in a Visual C++ language environment. The following samples can be found on the CD that was provided with the package or by downloading the latest version from ICP DAS web site.

For Visual C++ applications, these demo programs can be obtained from:

CD:\wp-5231\Demo\PAC\Vc2008\Standard\

[http://ftp.icpdas.com/pub/cd/winpac\\_am335x/wp-5231/demo/pac/vc2008/standard/](http://ftp.icpdas.com/pub/cd/winpac_am335x/wp-5231/demo/pac/vc2008/standard/)

Folder	Demo	Explanation
buzzer	buzzer	Shows how to make a simple buzzer beep.
DeviceInformation	DeviceInformation	Retrieves information about the OS version, CPU version, SDK version, etc.
GetRotaryID	GetRotaryID	Retrieves information about the status of the rotary switch
Memory	Memory	Shows how to read/write data values from/to the EEPROM or the backplane of the SRAM
MultiRT	MultiRT	Shows how to manage the microSD
RealTimeTest	RealTimeTest	Writes the managed cod for the rich graphical user interface that does not require true real-time performance
Registry	Registry	Shows how to read/write data values from/to the registry
UART	UART	Shows how to read the name of a local I/O modules via a UART
WatchDog	WatchDog	Displays information about how to operate the watchdog

## 5.2. PAC IO APIs

The diagram below shows the types of the PAC IO APIs provided in the PACSDK or the specified SDK.

For more information about the APIs and samples provided by the expansion I/O modules, please refer to chapter 6. I/O Modules and SDK Selection.

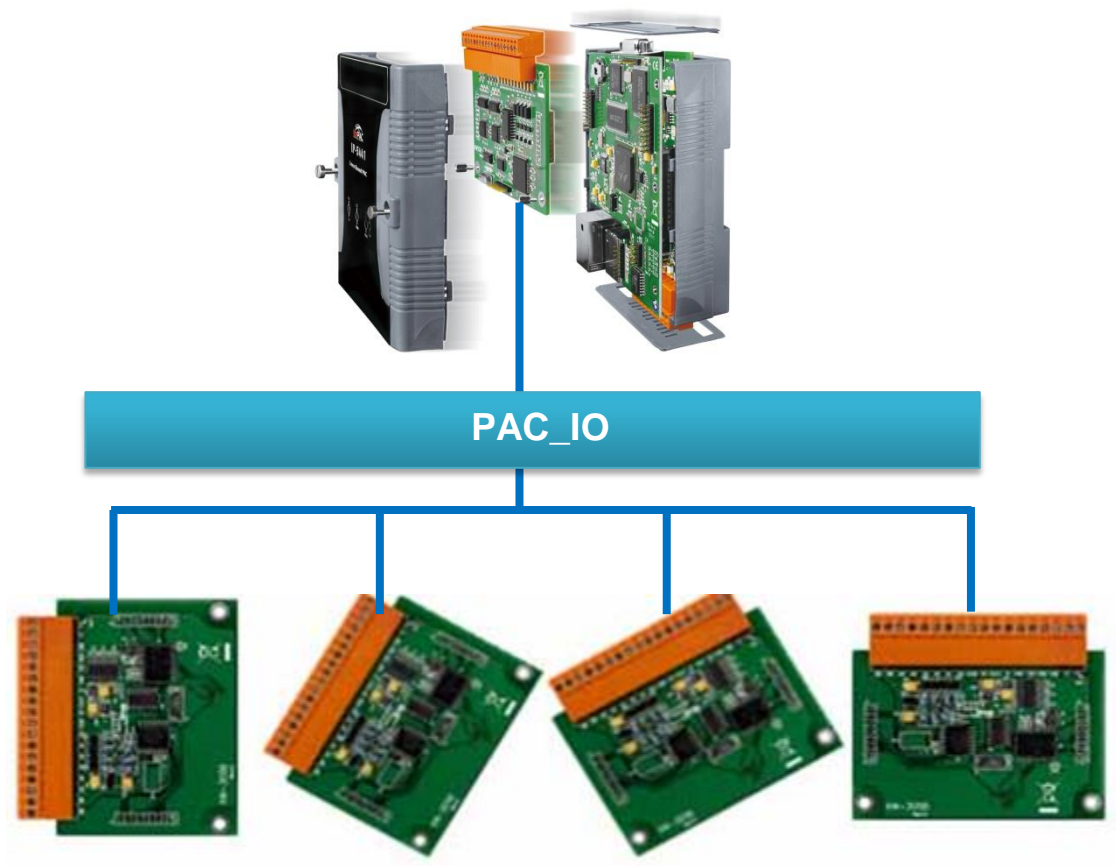

## 5.2.1. VB.NET Samples for PAC Standard APIs

The PAC SDK includes the following samples that demonstrate the use of the PAC IO APIs in a VB.NET language environment. The following samples can be found on the CD that was provided with the package or by downloading the latest version from ICP DAS web site.

For VB.NET applications, these demo programs can be obtained from:

CD:\wp-5231\Demo\PAC\Vb.net\IO\

[http://ftp.icpdas.com/pub/cd/winpac\\_am335x/wp-5231/demo/pac/vb.net/io/](http://ftp.icpdas.com/pub/cd/winpac_am335x/wp-5231/demo/pac/vb.net/io/)

Folder	Demo	Explanation
XVBoard/XV107	XV107_Modbus_RTU_Master_VB_demo	Shows how to use the XV107 module of the XV-board
Remote (I-7000 or I-87K modules in RU-87Pn I/O unit)		For full details regarding the remote I/O modules and its demos, please refer to: <a href="http://ftp.icpdas.com/pub/cd/winpac_am335x/wp-5231/demo/pac/applicable_demo_for_7k_module.pdf">http://ftp.icpdas.com/pub/cd/winpac_am335x/wp-5231/demo/pac/applicable_demo_for_7k_module.pdf</a>

## 5.2.2. C# Samples for PAC Standard APIs

The PAC SDK includes the following samples that demonstrate the use of the PAC IO APIs in a C# language environment. The following samples can be found on the CD that was provided with the package or by downloading the latest version from ICP DAS web site.

For C# applications, these demo programs can be obtained from:

CD:\wp-5231\Demo\PAC\C#\IO\

[http://ftp.icpdas.com/pub/cd/winpac\\_am335x/wp-5231/demo/pac/c%23/io/](http://ftp.icpdas.com/pub/cd/winpac_am335x/wp-5231/demo/pac/c%23/io/)

Folder	Demo	Explanation
XVBoard/XV107	ModbusRTU_Master_Console	Shows how to use the XV107 module of the XV-board in console mode
	XV107_Modbus_RTU_Master_demo	Shows how to use the XV107 module of the XV-board
Remote (I-7000 or I-87K modules in RU-87Pn I/O unit)	For full details regarding the remote I/O modules and its demos, please refer to: <a href="http://ftp.icpdas.com/pub/cd/winpac_am335x/wp-5231/demo/pac/applicable_demo_for_7k_module.pdf">http://ftp.icpdas.com/pub/cd/winpac_am335x/wp-5231/demo/pac/applicable_demo_for_7k_module.pdf</a>	



### 5.2.3. Visual C++ Samples for PAC Standard APIs

The PAC SDK includes the following samples that demonstrate the use of the PAC Standard APIs in a Visual C++ language environment. The following samples can be found on the CD that was provided with the package or by downloading the latest version from ICP DAS web site.

For Visual C++ applications, these demo programs can be obtained from:

CD:\wp-5231\Demo\PAC\Vc2008\IO\

[http://ftp.icpdas.com/pub/cd/winpac\\_am335x/wp-5231/demo/pac/vc2008/io/](http://ftp.icpdas.com/pub/cd/winpac_am335x/wp-5231/demo/pac/vc2008/io/)

Folder	Demo	Explanation
Remote (I-7000 or I-87K modules in RU-87Pn I/O unit)		For full details regarding the remote I/O modules and its demos, please refer to: <a href="http://ftp.icpdas.com/pub/cd/winpac_am335x/wp-5231/demo/pac/applicable_demo_for_7k_module.pdf">http://ftp.icpdas.com/pub/cd/winpac_am335x/wp-5231/demo/pac/applicable_demo_for_7k_module.pdf</a>

# 6. I/O Modules and SDK Selection

This chapter describes how to select a suitable I/O expansion module and the corresponding SDK library to be used for developing programs on WinPAC series devices.

## Selecting an SDK Library for I/O Expansion

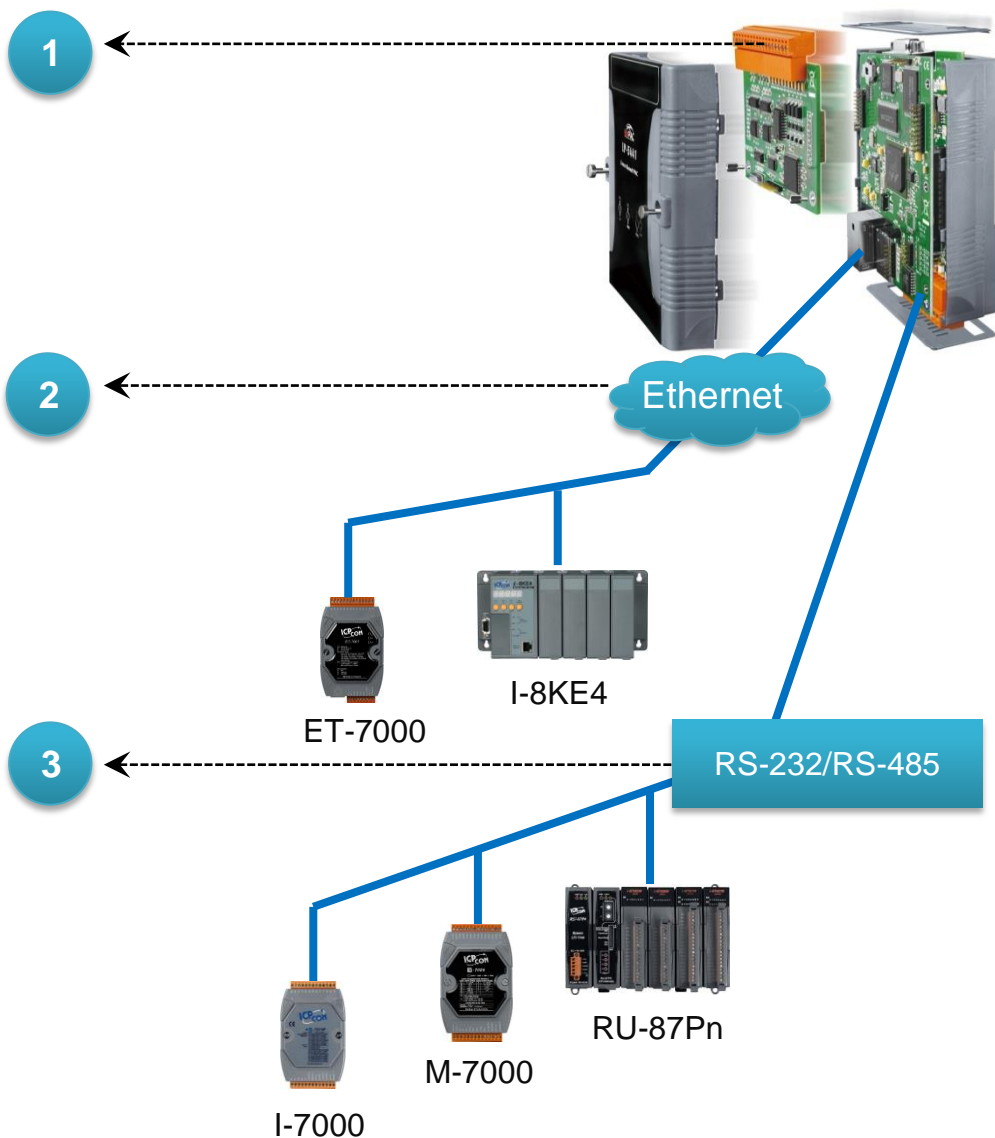

## 1 Local I/O Module (XV-Board)

There are more than 8 XV-Board available for expanding the function of the WP-5231. The following table shows the appropriate SDK library to be used for I/O modules.

Module	Native SDK	.NET CF SDK
XV-Board	Modbus Demo	Modbus Demo

For more detailed information about these support modules, please refer to

[http://www.icpdas.com/root/product/solutions/hmi\\_touch\\_monitor/touchpad/xv-board\\_selection.html](http://www.icpdas.com/root/product/solutions/hmi_touch_monitor/touchpad/xv-board_selection.html)

## 2 RS-485 (I-7000 series and M-7000 series)

I-7000, M-7000, RU-87Pn and high profile I-87K series modules connect to WP-5231 series devices via a twisted-pair, multi-drop, 2-wire RS-485 network.

### ➤ I-7000 series I/O modules

Module	Native SDK	.NET CF SDK
I-7000 series	PACSDK.dll	PACNET.dll
I-7000 series with I-7088 (D)	PACSDK_PWM.dll	PACNET.dll

For full details regarding I-7000 series I/O modules and its demos, please refer to:

[http://ftp.icpdas.com/pub/cd/winpac\\_am335x/wp-5231/demo/pac/applicable\\_demo\\_for\\_7k\\_module.pdf](http://ftp.icpdas.com/pub/cd/winpac_am335x/wp-5231/demo/pac/applicable_demo_for_7k_module.pdf)

➤ **M-7000 series I/O modules**

Module	Native SDK	.NET CF SDK
M-7000 series	Modbus Demo	Modbus Demo

For more detailed information about M-7000 series modules using Modbus protocol and its demos, please refer to:

[http://ftp.icpdas.com/pub/cd/winpac\\_am335x/wp-5231/demo/nmodbus/](http://ftp.icpdas.com/pub/cd/winpac_am335x/wp-5231/demo/nmodbus/)

➤ **RU-87Pn + I-87K series I/O modules**

Module	Native SDK	.NET CF SDK
RU-87Pn + I-87K	PACSDK.dll	PACNET.dll

➤ **Other specified I/O**

Module	Native SDK	.NET CF SDK
I-7088W	PACSDK_PWM.dll	PACNET.dll

**③ Ethernet (ET-7000 series and I-8KE4/8-MTCP)**

The Ethernet I/O devices available include ET-7000 and I-8KE4/8-MTCP, and support the Modbus/TCP communication protocol.

Module	Native SDK	.NET CF SDK
ET-7000	Modbus Demo	Modbus Demo
I-8KE4/8-MTCP	Modbus Demo	Modbus Demo

For more detailed information about ET-7000 and I-8KE4/8-MTCP series modules using Modbus protocol and its demos, please refer to:

[http://ftp.icpdas.com/pub/cd/winpac\\_am335x/wp-5231/demo/nmodbus/](http://ftp.icpdas.com/pub/cd/winpac_am335x/wp-5231/demo/nmodbus/)

# 7. WP-5231 Updates

This chapter provides information of the ViewPAC OS and SDKs, and a guided tour that demonstrates the steps needed to update the ViewPAC OS and SDKs.

ICP DAS will continue to add additional features to WinPAC-5231 SDK and OS in the future, so we advise you to periodically check the ICP DAS web site for the latest updates.

Both the files of OS updates and SDK updates can be found on the CD that was provided with the package or by downloading the latest version from ICP DAS web site.

CD:\wp-5231\  
http://ftp.icpdas.com/pub/cd/winpac\_am335x/wp-5231/

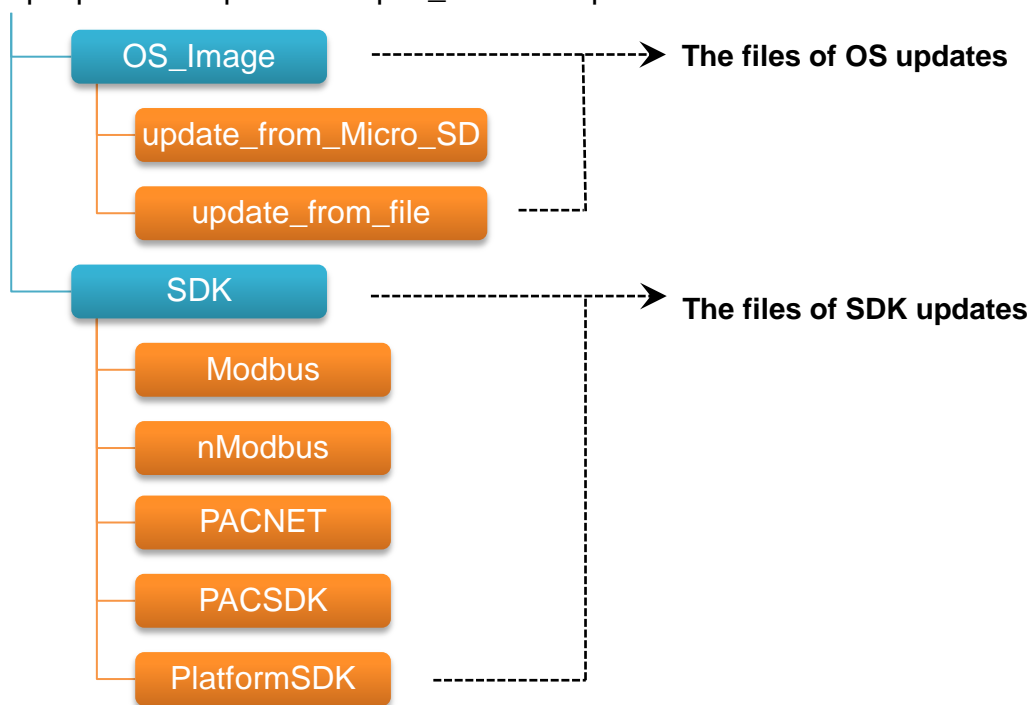

## 7.1. OS Updates

OS updates are part of the WP-5231 updates services to provide additional and more efficient features and functionality for WP-5231 operating system.

The updates files of OS image can be found separately on the CD that was provided with the package or by downloading the latest version from ICP DAS web site.

CD:\wp-5231\OS\_Image\  
http://ftp.icpdas.com/pub/cd/winpac\_am335x/wp-5231/os\_image/

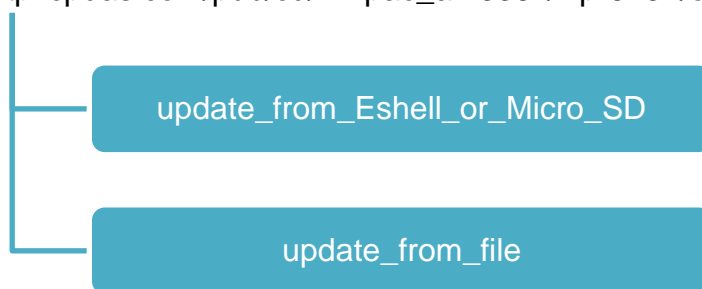

There are two ways to update the OS:

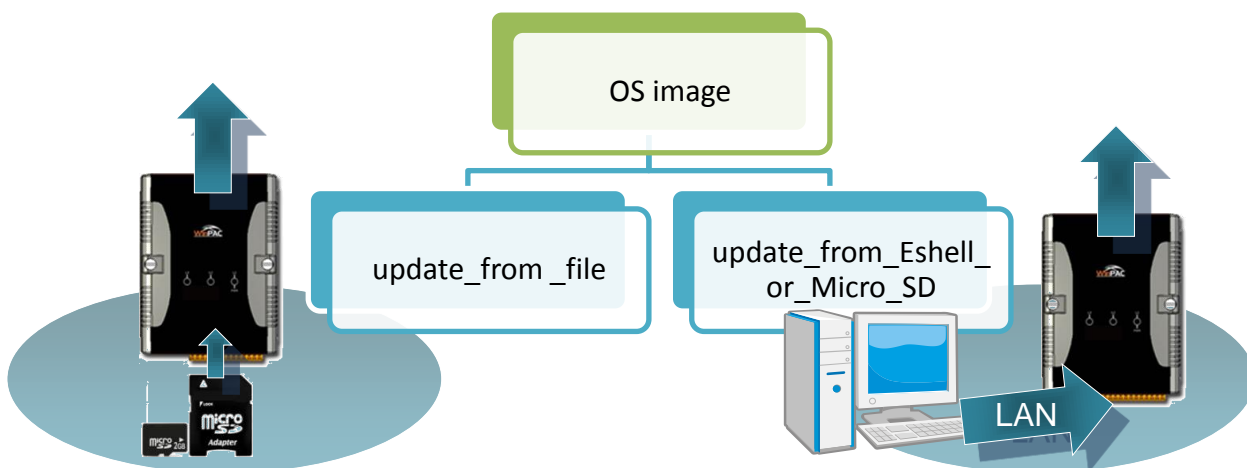

1. Update from eshell (Please refer to section 7.1.1)

(We recommend that you use this one for more quicker and easier to update)

2. Update from micro\_SD (Please refer to section 7.1.2)

## 7.1.1. OS Updates using Eshell

By default, the OS updates via LAN. Therefore, to update the OS image, make sure LAN is connected to the PC.



### Step 1: Get the latest version of the installation package file and then unzip it

The latest version of the installation package file can be found from ICP DAS web site.

[http://ftp.icpdas.com/pub/cd/winpac\\_am335x/wp-5231/os\\_image/update\\_from\\_eshell\\_or\\_micro\\_sd/](http://ftp.icpdas.com/pub/cd/winpac_am335x/wp-5231/os_image/update_from_eshell_or_micro_sd/)

### Step 2: Run the registry clear.exe

The registry.exe can be found on the CD that was provided with the package or by downloading the latest version from ICP DAS web site.

CD:\wp-5231\PC\_Tools\Eshell

[http://ftp.icpdas.com/pub/cd/winpac\\_am335x/wp-5231/pc\\_tools/eshell/](http://ftp.icpdas.com/pub/cd/winpac_am335x/wp-5231/pc_tools/eshell/)



### Step 3: Place the rotary switch in position 3, OS update mode

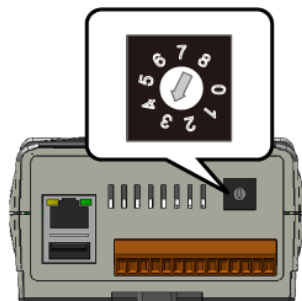

#### Step 4: Run the ESHELL.exe, and then restart the WP-5231

The ESHELL.exe can be found on the CD that was provided with the package or by downloading the latest version from ICP DAS web site.



CD:\wp-5231\PC\_Tools\Eshell

[http://ftp.icpdas.com/pub/cd/winpac\\_am335x/wp-5231/pc\\_tool/s/eshell](http://ftp.icpdas.com/pub/cd/winpac_am335x/wp-5231/pc_tool/s/eshell)

#### Step 5: Select the device which you want to update the OS image, and then click OK

Select the device name which you want to update the OS image from the list.

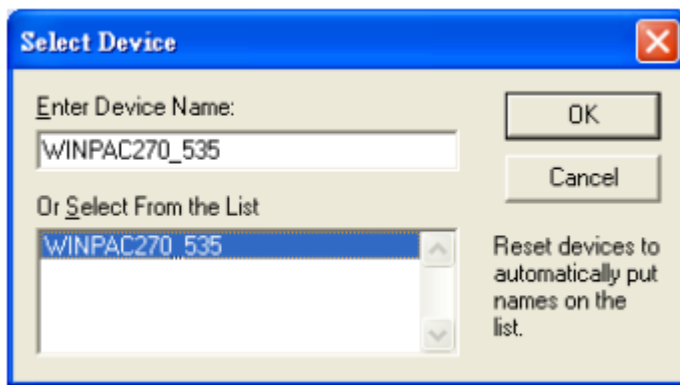

#### Step 6: Select the latest version of the OS image file

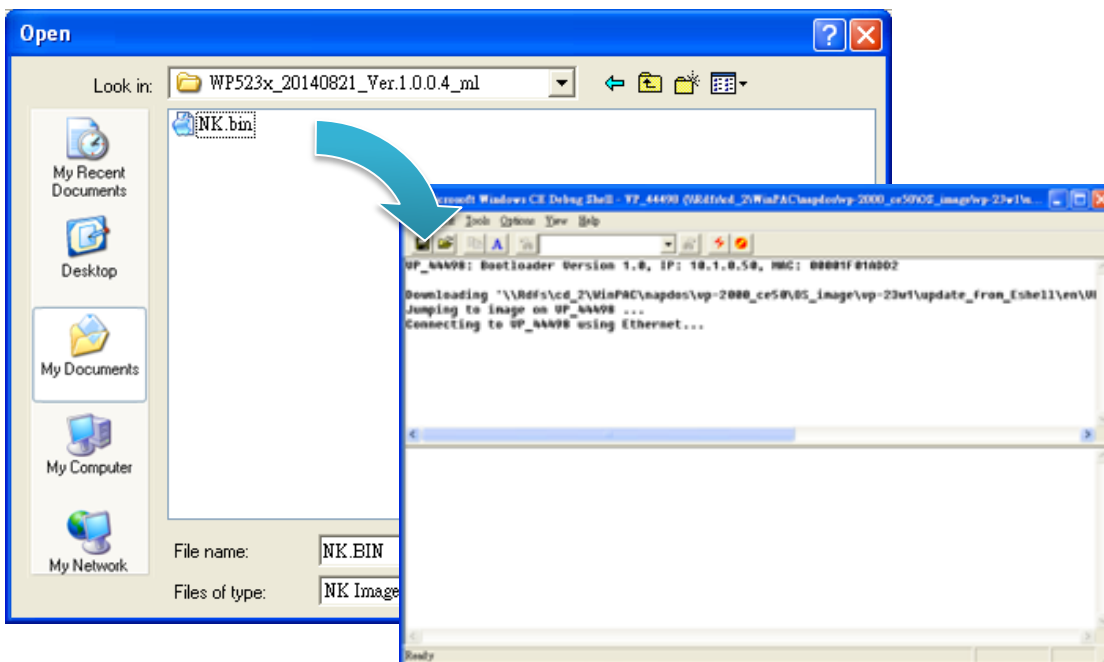



**Step 7: Once the procedure is completed, the “Warning !” dialog box will appear as below shown, then turn the rotary switch in position 0, normal mode**

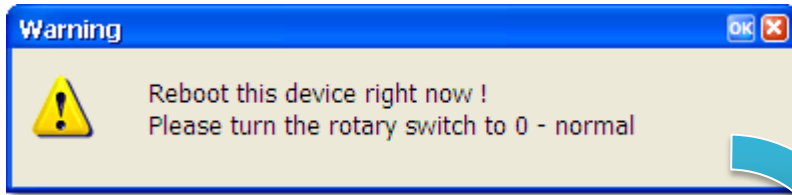

**Step 8: Click the OK button**

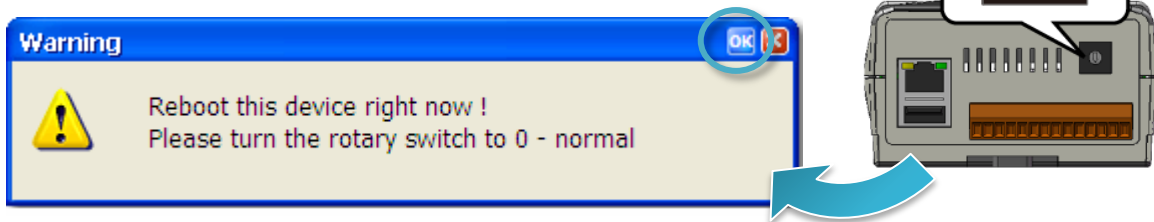

**Step 9: Check the OS version**

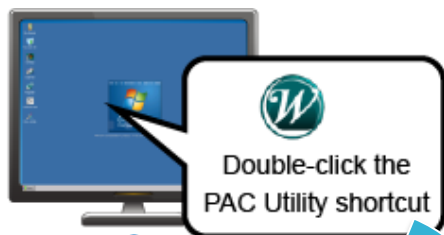

Start the PAC Utility, and then select the “Device Information” tab to check the current OS version.

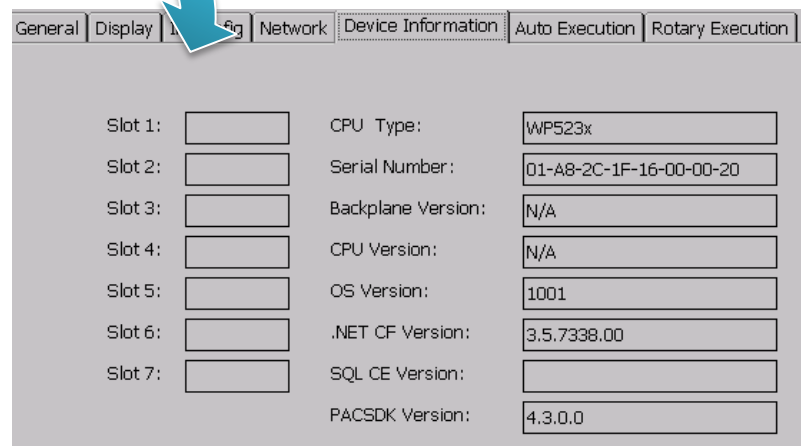

## 7.1.2. OS Updates using micro\_SD

The microSD card can be used to reinstall the WP-5231 OS image to factory default settings in the event of the WP-5231 failure.

### Step 1: Get the latest version of the installation package file, then unzip the file, and then copy them to microSD card

The latest version of the installation package file can be found from ICP DAS web site.

[http://ftp.icpdas.com/pub/cd/winpac\\_am335x/wp-5231/os\\_image/update\\_from\\_es\\_hell\\_or\\_micro\\_sd](http://ftp.icpdas.com/pub/cd/winpac_am335x/wp-5231/os_image/update_from_es_hell_or_micro_sd)

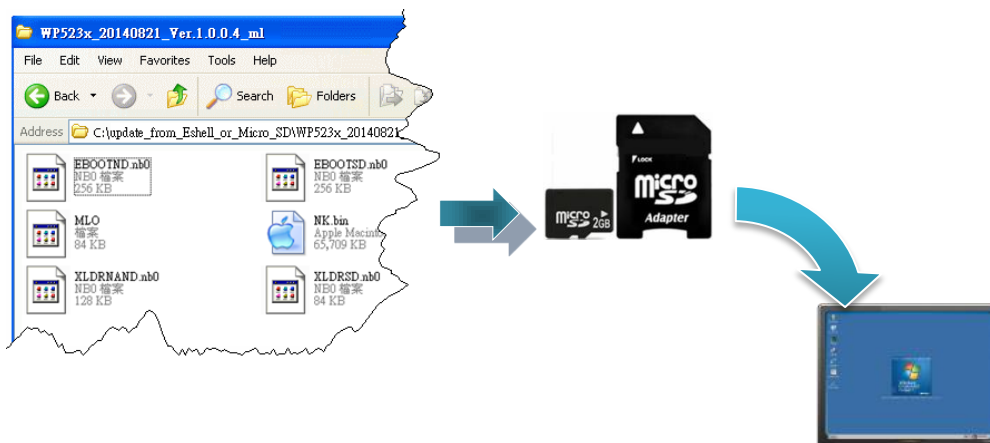

### Step 2: Plug the microSD card into microSD slot

### Step 3: Turn the rotary switch in position 5, OS update mode

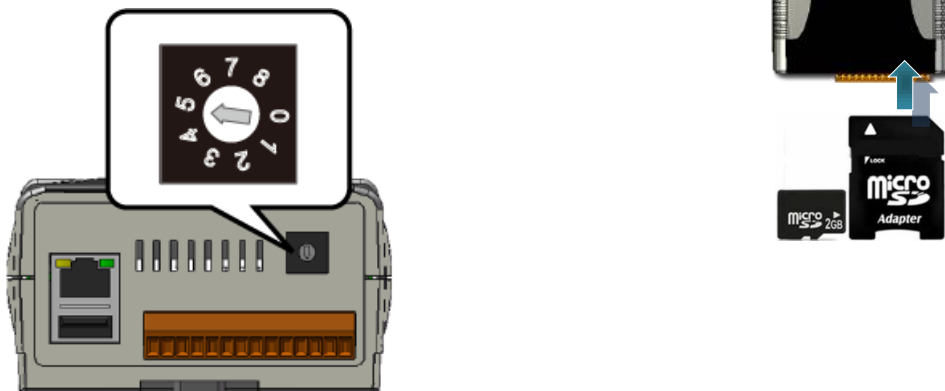

**Step 4: Reboot the WP-5231**

**Step 5: Wait a few minutes for the following desktop to be displayed**



**Step 6: Turn the rotary switch in position 0, normal mode**

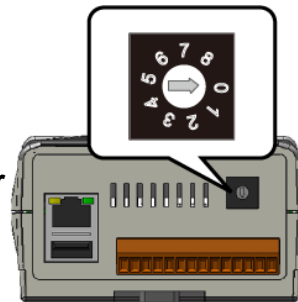

**Step 7: Reboot the WP-5231**

**Step 8: Check the OS version**

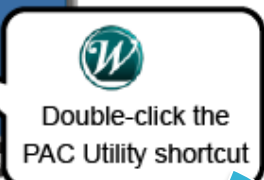
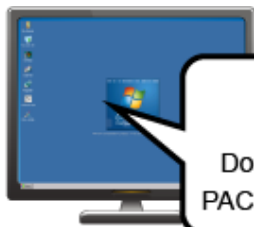

Start the PAC Utility, and then select the "Device Information" tab to check the current OS version.

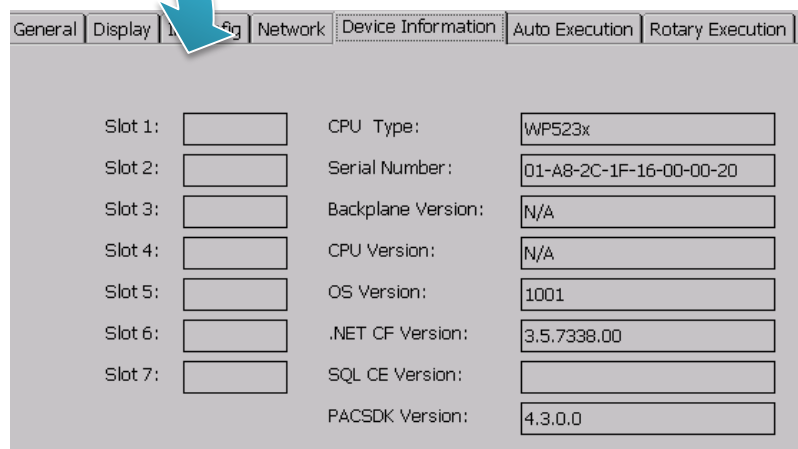

## 7.2. SDK Updates

SDK updates are part of the WP-5231 updates services to provide additional and more efficient features and functionality for WP-5231 operating system.

The updates files of SDK files can be found separately on the CD that was provided with the package or by downloading the latest version from ICP DAS web site.

CD:\wp-5231\SDK\

[http://ftp.icpdas.com/pub/cd/winpac\\_am335x/wp-5231/sdk/](http://ftp.icpdas.com/pub/cd/winpac_am335x/wp-5231/sdk/)

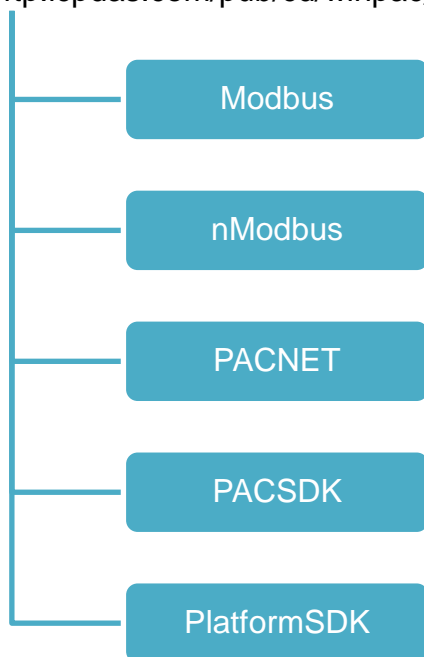

## 7.2.1. SDK Updates for VB.NET or C#

You can just change the old one with a new one.

### **Step 1: Get the latest version of the ViewPAC SDK components**

The latest version of the ViewPAC SDK can be obtained from ICP DAS web site.

[http://ftp.icpdas.com/pub/cd/winpac\\_am335x/wp-5231/sdk/pacnet/](http://ftp.icpdas.com/pub/cd/winpac_am335x/wp-5231/sdk/pacnet/)

### **Step 2: Copy the latest version of DLL to PC and ViewPAC**

The DLL files on PC are located at anywhere only the solution can reference it.

The DLL files on ViewPAC are located at the same directory as the .exe file.

## 7.2.2. SDK Updates for Visual C++

You can just change the old one with a new one.

### Step 1: Get the latest version of the VC++ components

The latest version of the VC++ components can be obtained from:  
[http://ftp.icpdas.com/pub/cd/winpac\\_am335x/wp-5231/sdk/pacsdk/](http://ftp.icpdas.com/pub/cd/winpac_am335x/wp-5231/sdk/pacsdk/)

### Step 2: Copy the latest version of header files and libraries to Host PC

The header files are located at:

C:\Program Files\Windows CE

Tools\SDKs\AM335x\_WINCE7\_SDK\Include\Armv4i

The libraries are located at:

C:\Program Files\Windows CE Tools\SDKs\AM335x\_WINCE7\_SDK\Lib\ARMv4I

### Step 3: Copy the latest version of DLL files to WinPAC

The DLL files are located at:

\System\_Disk\ICPDAS\System

# A. Tips – How to

This chapter provides tips and a guided tour on using and maintaining the WinPAC.

## A.1. How to use the Printer

WinPAC have ability to access the printer, you can connect to the printer via Ethernet network or USB.

### Tips & Warnings

---



WinPAC only supports HP Laser Jet Printers which support PCL6 driver. The following printer support is released by HP

- HP LaserJet 4000 series/HP LaserJet 4100 series
- HP LaserJet 2100 series/HP LaserJet 2200 series
- HP LaserJet 1200
- HP LaserJet 3200/HP LaserJet 3300
- HP LaserJet 4200 series/HP LaserJet 4300 series
- HP LaserJet 5000 series/HP LaserJet 5100 series
- HP LaserJet 8000 series
- HP LaserJet 9000 series printers

If you need the latest support of HP PCL6 printer, you can refer to following link  
<http://h20000.www2.hp.com/bizsupport/TechSupport/Document.jsp?objectID=bpl04568>

---

## A.1.1. How to use the network printer

Here are step by step instructions on how to use a shared printer.

**Step 1: On PC side, check the name of the PC and the shared printer**

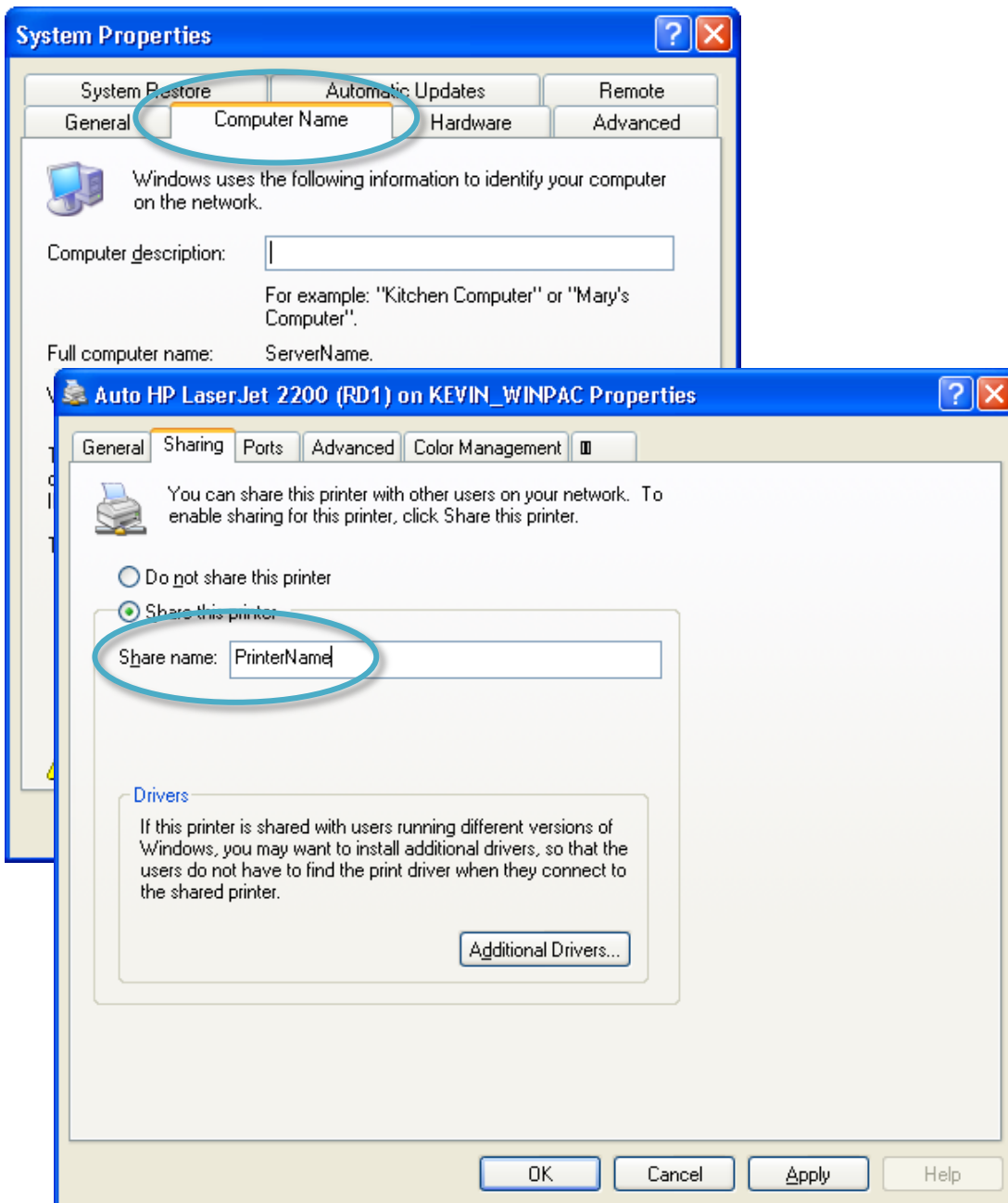



**Step 2: On WinPAC – Run the Notepad, and then open a WordPad format file**

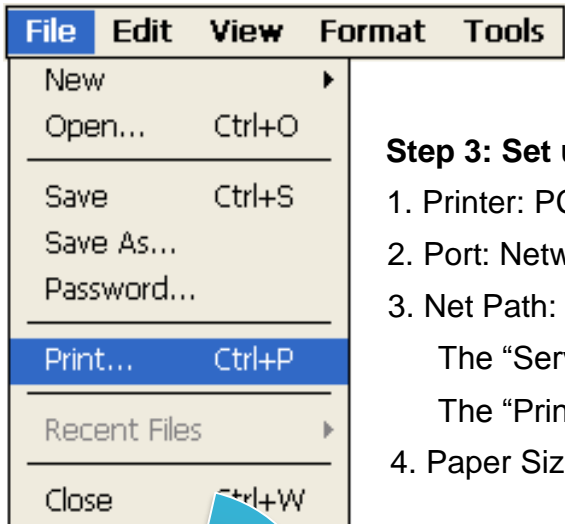

**Step 3: Set up the printer**

1. Printer: PCL Laser
2. Port: Network
3. Net Path: \\ServerName\PrinterName

The "ServerName" is the name or IP of the PC.

The "PrinterName" is the name of share printer of the PC.

4. Paper Size: Select the paper size



**Test !!!**

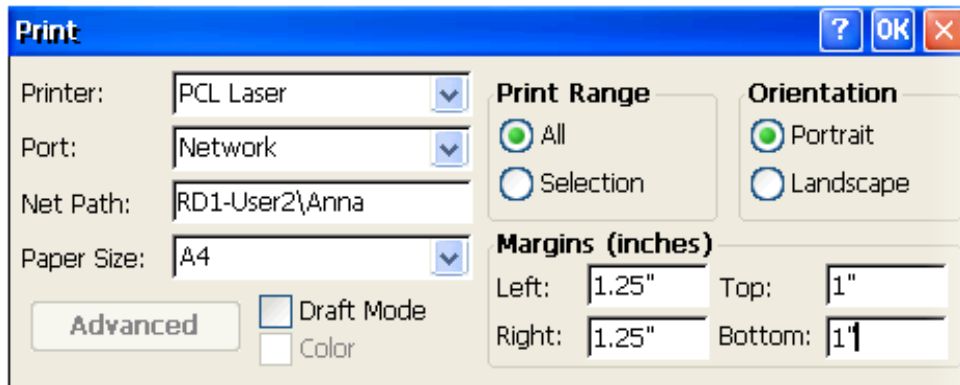

## A.1.2. How to use the USB printer

Here are step by step instructions on how to use a shared printer.

### Step 1: Run the Notepad, and then open a WordPad format file

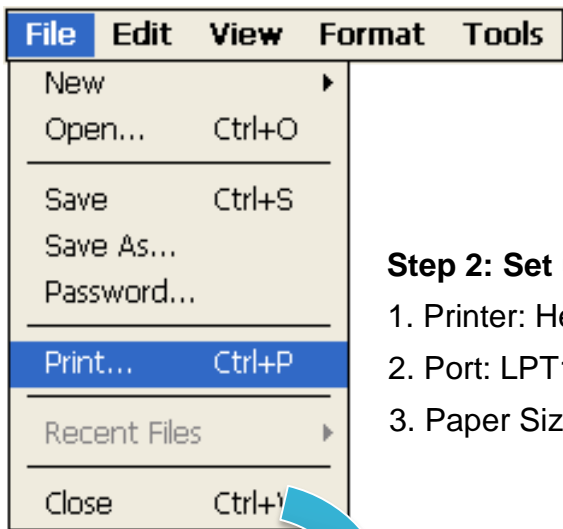

### Step 2: Set up the printer

1. Printer: Hewlett-Packard LaserJet
2. Port: LPT1
3. Paper Size: Select the paper size



**Test !!!**

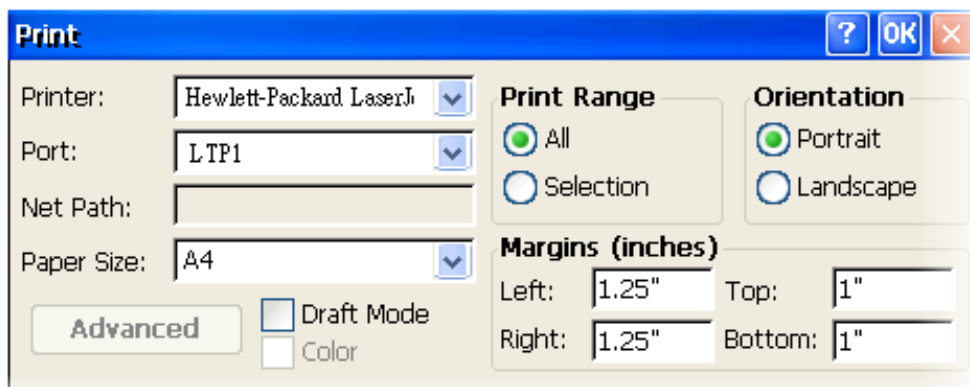

## A.2. How to Automatically Synchronize WinPAC Clock with an Internet Time Server

You can synchronize your WinPAC clock with an Internet time server.

If synchronization is enabled, the WinPAC clock is synchronized with an Internet time server.

### Step 1: Double-click the PAC Utility on the desktop

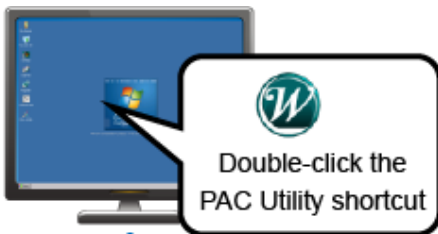

### Step 2: On the General tab, press Configure button

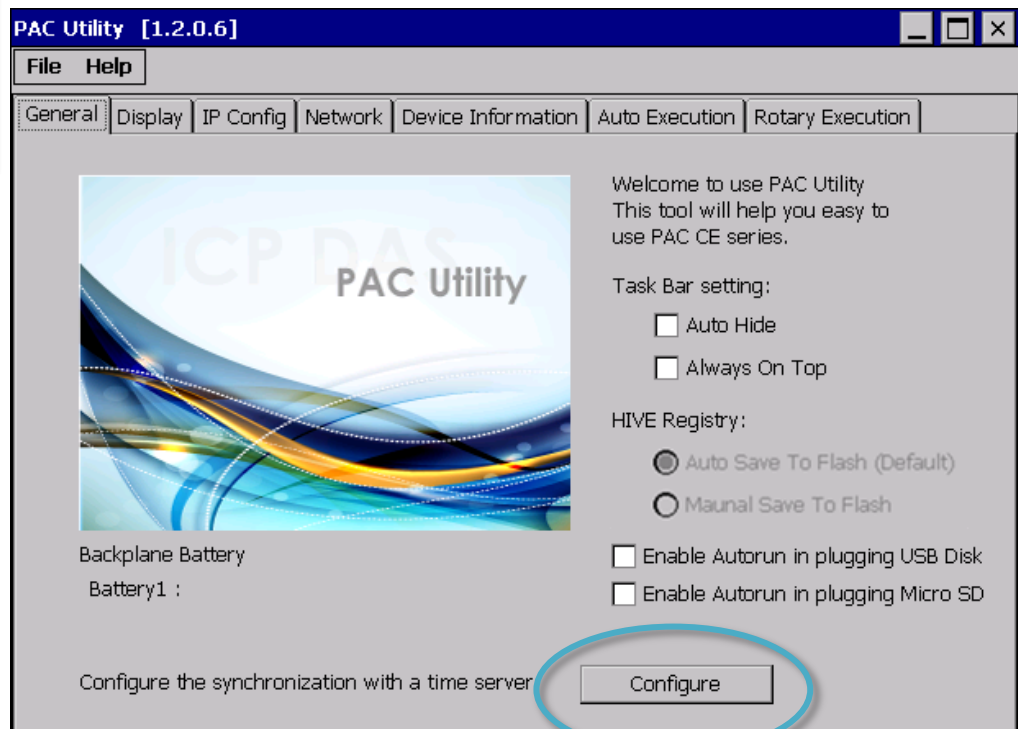

**Step 3: Select the domain name from the Server drop-down list, and then enter a value in the Autoupdate Frequency field**

**Step 4: Check the Automatically synchronize with an internet time server box**

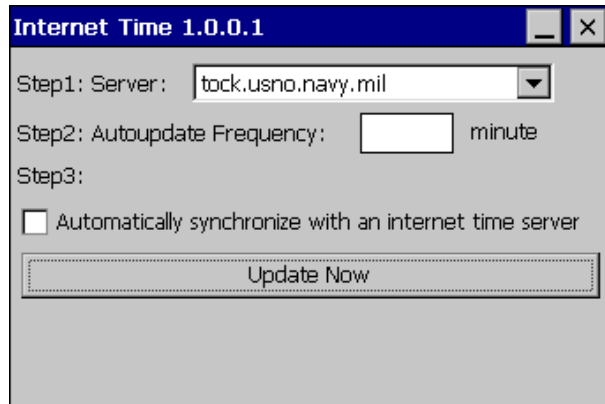

**check**

**Step 5: On the File menu, click Reboot**

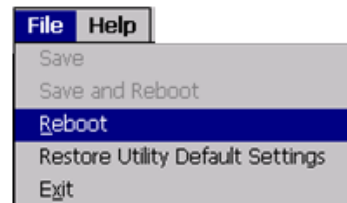

**Step 6: The WinPAC will automatically synchronize with an internet time server regularly**

**Step 7: Click the Update Now button to synchronize WinPAC clock immediately**

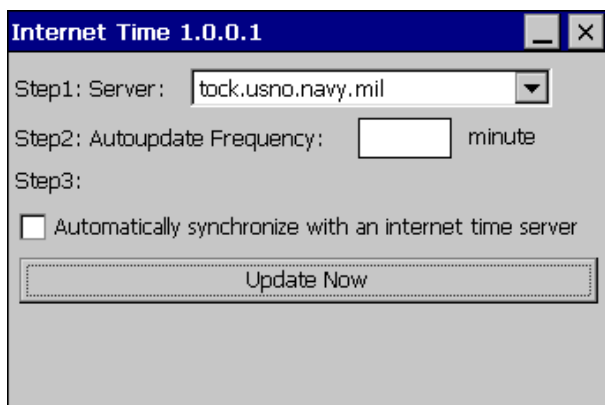

## A.3. How to use User Account Control in WinPAC

### A.3.1. How to Create an User Account

Here are step by step instructions on how to add a user account.

**Step 1: Double-click the PAC Utility on the desktop**

**Step 2: On the Login tab of the Network tab, click Login tab, type the User Name and Password, and then click Add button**

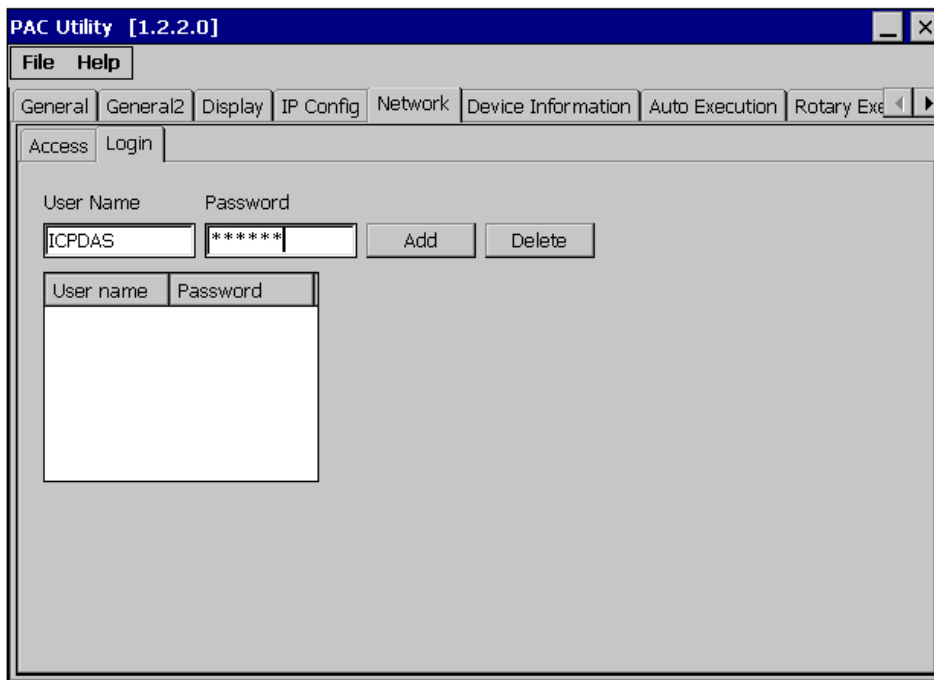

**Step 3: The user has been added to the allowed under the remote login and included in the following list**

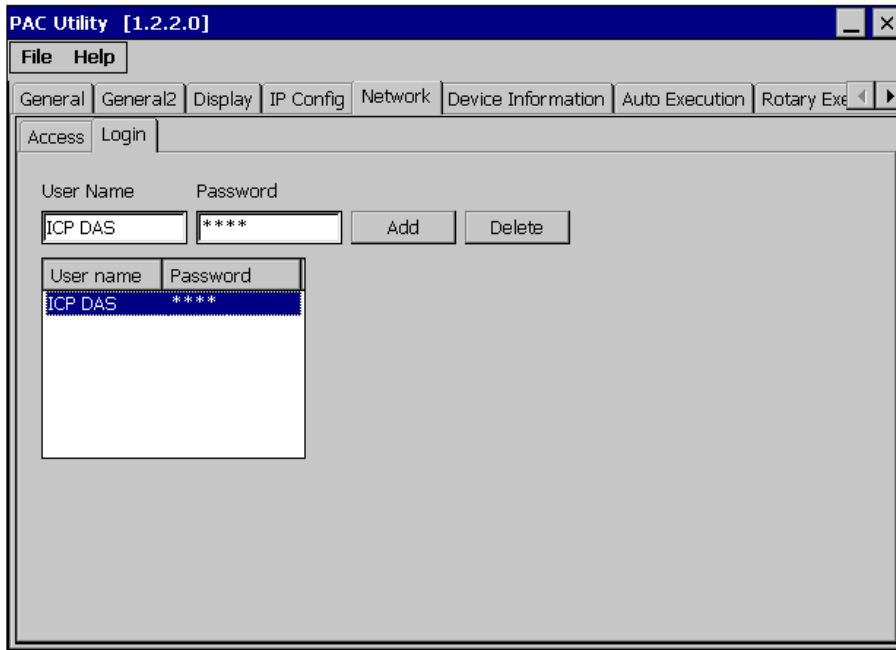

**Step 4: On the File menu, click Reboot for changes to take effect**

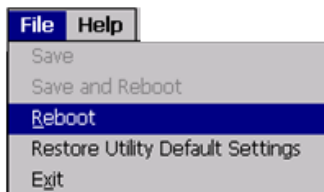

### A.3.2. How to Use Telnet to remote login the WinPAC from PC

Here are step by step instructions on how to use telnet to remote login the WinPAC from PC.

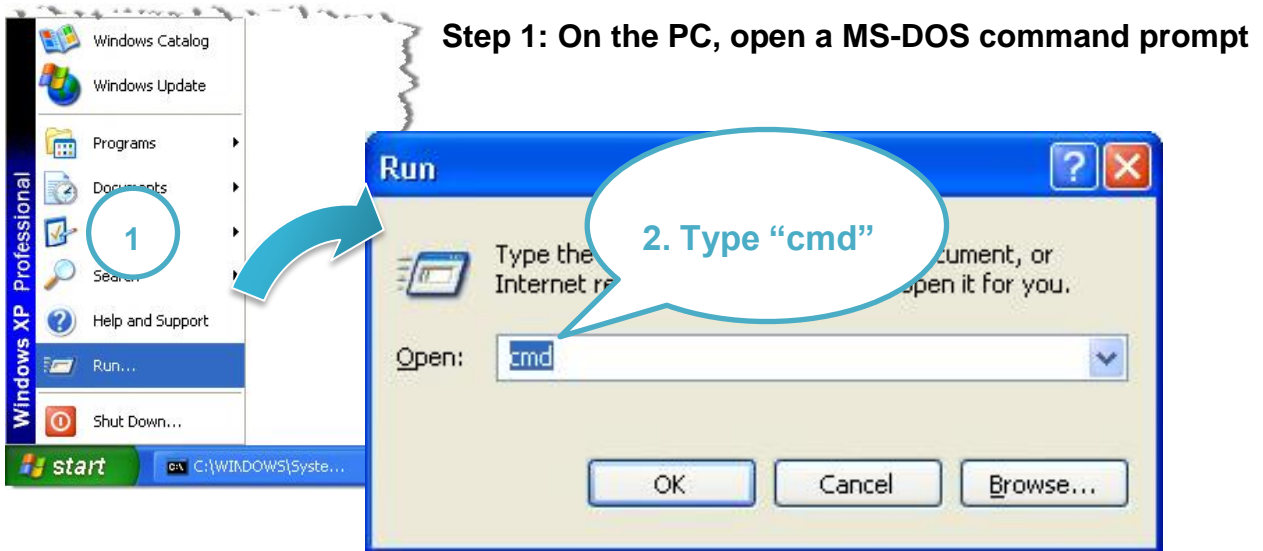

**Step 2: At the command prompt, type "telnet (IP address)"**

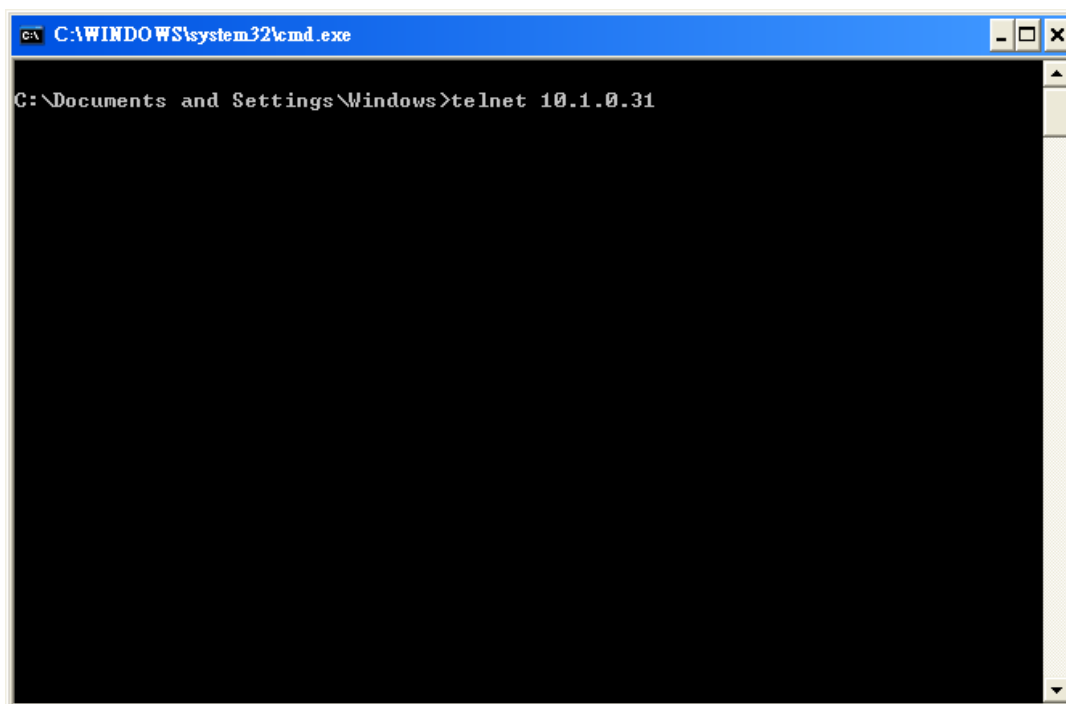

**Step 3: The connection has been set up, and then type the name and password**

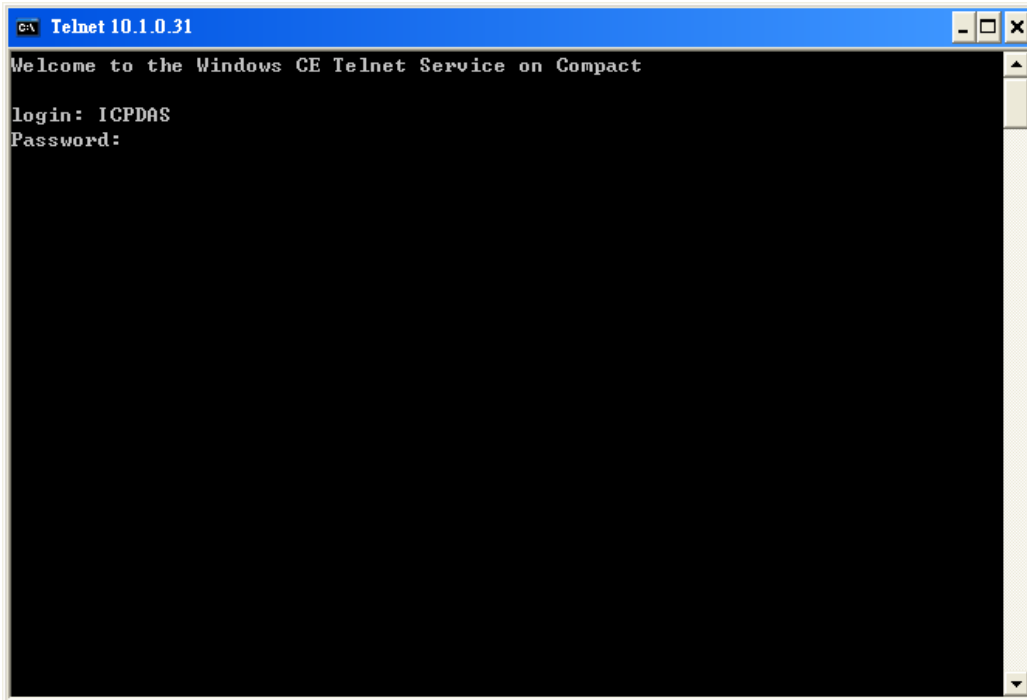

**Step 4: The remote login has been completed**

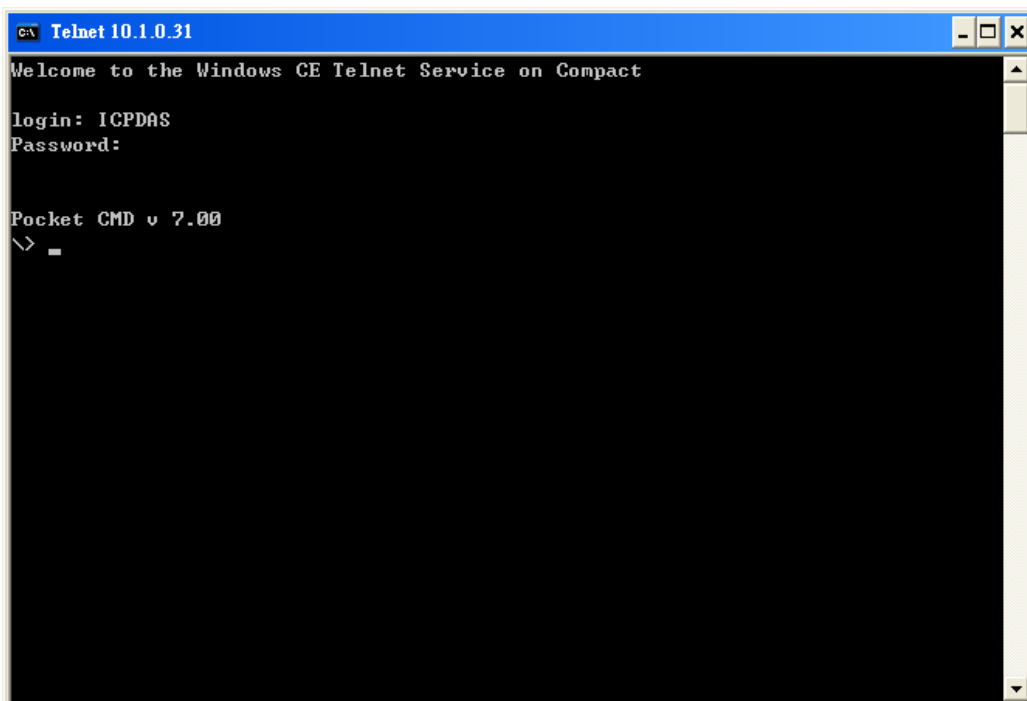



### A.3.3. How to Remove a User Account from the Login List

Here are step by step instructions on how to remote the user from the login list.

**Step 1: Click a user from the list which you want to remove, and the user will display in the field, and then press Delete to delete the user from the login list**

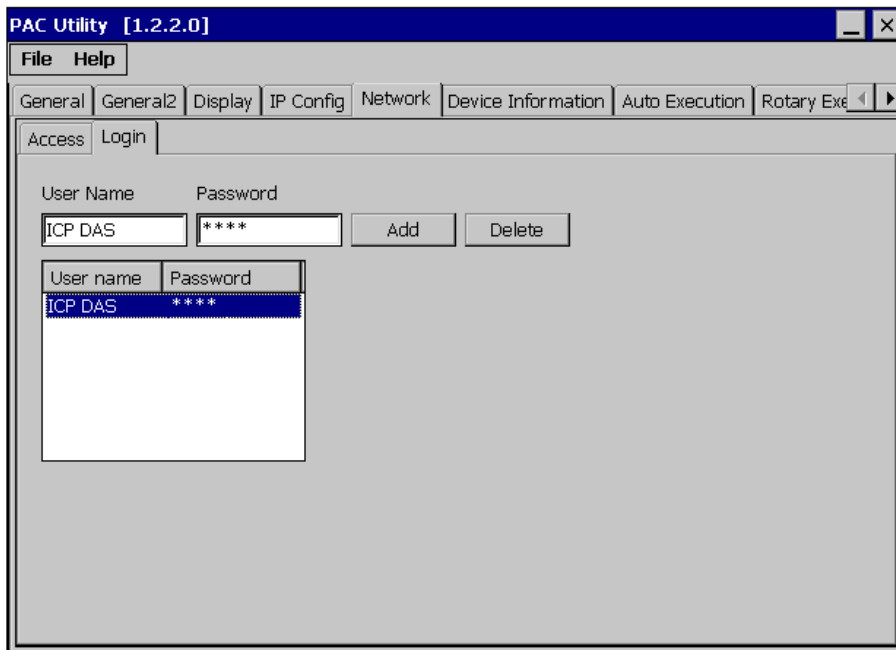

**Step 2: On the File menu, click for changes to take effect**

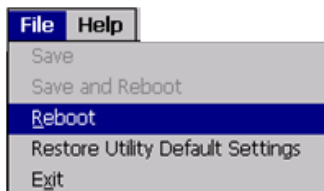

## B. XV-Board Modules

The XV-board series are for LP-5000, WP-5231. One PAC can only plug only one XV-board. The XV-board series have following common specification:



- DI channel is dry contact, sink type.
- DO channel is open collector, sink type.

### DIO Expansion

Model	DI			DO	
	Channel	Type	Sink/Source	Channel	Sink/Source
XV107	8	Wet	Source	8	Sink
XV107A			Sink		Source
XV110	16	Dry/Wet	Sink/Source	-	-
XV111	-			16	Sink
XV111A					Source

### Relay Output Expansion

Model	DI			Relay Output	
	Channel	Type	Sink/Source	Channel	Type
XV116	5	Wet	Sink/Source	2	Signal Relay
				4	Power Relay

### Multi-Function Expansion

Model	AI	AO	DI			DO	
	Channel			Type	Sink/Source	Channel	Sink/Source
XV308	8	-	DI+DO=8	Dry/Wet	Source	DI+DO=8	Sink
XV310	4	5	4		Sink		Source

For more detailed information about these support modules, please refer to [http://www.icpdas.com/root/product/solutions/hmi\\_touch\\_monitor/touchpad/xv-board\\_selection.html](http://www.icpdas.com/root/product/solutions/hmi_touch_monitor/touchpad/xv-board_selection.html)

## C. Revision History

This chapter provides revision history information to this document.

The table below shows the revision history.

Revision	Date	Description
1.0.0	January 2015	Initial issue