



XP-9000-IoT Series

User Manual

V1.1.2 May 2021



XP-9181-IoT/XP-9381-IoT/XP-9781-IoT

Written by Mac Cho
Edited by Jeffery Hong

Warranty

All products manufactured by ICP DAS are under warranty regarding defective materials for a period of one year, beginning from the date of delivery to the original purchaser.

Warning

ICP DAS assumes no liability for any damage resulting from the use of this product. ICP DAS reserves the right to change this manual at any time without notice. The information furnished by ICP DAS is believed to be accurate and reliable. However, no responsibility is assumed by ICP DAS for its use, not for any infringements of patents or other rights of third parties resulting from its use.

Copyright

Copyright © 2016 by ICP DAS Co., Ltd. All rights are reserved.

Trademark

The names used for identification only may be registered trademarks of their respective companies.

Contact US

If you have any problem, please feel free to contact us.

You can count on us for quick response.

Email: service@icpdas.com

Contents

1. Introduction	5
1.1. Features	6
1.2. Specifications	9
1.3. Overview	14
1.4. Dimensions	22
1.5. Rescue CF Card.....	24
2. Getting Started	25
2.1. Mounting the XP-9000-IoT	26
2.2. Installing the RJ-45 waterproof connector assembly	30
2.3. Deploying a Basic XP-9000-IoT System.....	34
2.4. Inserting the I/O Modules	36
2.5. Unable UWF to Allow Settings to Be Saved.....	38
2.6. Using DCON Utility Pro to Configure I/O Modules	40
3. Security and Risk.....	41
3.1. Creating and Managing User Accounts	42
3.2. Turning Firewall On or Off	50
3.3. Configuring the FTP Server	53
3.4. Configuring the UWF Manager	58
4. Tools and Tasks	64
4.1. PAC Utility	65
4.1.1. System Information	65
4.1.2. Auto Execution.....	66
4.1.3. UWF Operation	67
4.1.4. Multi-serial Port Module	68
4.2. DCON Utility Pro	69
5. Your First XP-9000-IoT Program	70
5.1. Your First XP-9000-IoT Program in VB.NET.....	71
5.1.1. Create a New Project	72
5.1.2. Specify the Path of PAC Reference	74
5.1.3. Add the Control to the Form	76
5.1.4. Add the Event Handling for the Control	78
5.1.5. Upload the Application to XP-9000-IoT	80
5.1.6. Execute the Application on XP-9000-IoT	80

5.2. Your First XP-9000-IoT Program in C#	83
5.2.1. Create a New Project	84
5.2.2. Specify the Path of PAC Reference	86
5.2.3. Add the Control to the Form	88
5.2.4. Add the Event Handling for the Control	90
5.2.5. Upload the Application to XP-9000-IoT	92
5.2.6. Execute the Application on XP-9000-IoT	94
5.3. Your First XP-9000-IoT Program in Visual C++	95
5.3.1. Create a New Project	96
5.3.2. Specify the Path of the PAC Reference	99
5.3.3. Add the Control to the Form	104
5.3.4. Add the Event Handling for the Control	106
5.3.5. Upload the Application to XP-9000-IoT	108
5.3.6. Execute the Application on XP-9000-IoT	109
6. I/O Modules and SDK Selection	110
7. APIs and Demo Programs	113
7.1. PAC Standard APIs	114
7.1.1. VB.NET Demo Programs for PAC Standard APIs	115
7.1.2. C# Demo Programs for PAC Standard APIs	116
7.1.3. Visual C++ Demo Programs for PAC Standard APIs	117
7.2. PAC IO APIs	118
7.2.1. VB.NET Demo Programs for PAC IO APIs	119
7.2.2. C# Demo Programs for PAC IO APIs	120
7.2.3. Visual C++ Demo Programs for PAC IO APIs	121
8. Restore and Recovery	122
8.1. Recovering the XP-9000-IoT	123
8.2. Restoring the Rescue CF Card	127
9. XP-9000-IoT Updates	131
9.1. Updating the XP-9000-IoT OS	132
9.2. Updating the XP-9000-IoT SDK	133
9.3. Updating the XP-9000-IoT Tools	135
10. XP-9000-IoT Download Center	138
Appendix	139
A. I-9K Modules and I-97K Modules	139
B. Revision History	141

1. Introduction

This chapter provides an overview of the XP-9000-IoT and its components, and introduces the fundamental concepts for user familiar with the XP-9000-IoT.



The XP-9000-IoT are Windows IoT based PACs that combine computing, I/O, and operator interface into a single unit, and provide the perfect solution for integrating HMI, data acquisition and control in an individual PAC. It is equipped with an Intel E3845/E3950/i5-8365UE CPU, I/O expansion slots and a variety of connectives including dual Gigabit Ethernet, HDMI, VGA , USB port, RS-232 and RS-485 interface. Local I/O slots are available to use our I-9K and I-97K series I/O modules and remote I/O expansions are available to use our Ethernet I/O modules and RS-485 I/O modules.

Since Windows IoT has the same Win32 API as Windows 10, most popular applications on desktop can run on Windows IoT based controllers.

1.1. Features

The XP-9000-IoT offers the most comprehensive configuration and remote system upgrade solutions to meet specific application requirements. The following list shows the software and hardware features designed to simplify installation, configuration and application.

Software Features

- Windows IoT (Windows 10 IoT Enterprise 2019 LTSC)



Windows 10 IoT is a member of the Windows 10 family that brings enterprise-class power, security, and manageability to the Internet of Things. It leverages Windows' embedded experience, ecosystem, and cloud connectivity, allowing organizations to create their Internet of Things with secure devices that can be quickly provisioned, easily managed, and seamlessly connected to an overall cloud strategy.

- Traditional Windows Shell with Advanced Lockdown Features
 - Full Windows UI support (e.g. UWP, WinForms, etc)
1. Rich Software Solutions
 2. Visual Studio .Net 2008 and VC solution: SDK as well as demo programs for C#, VB.Net, and VC are provided.
 3. eLogger HMI: A free charge and easy-to-use software to implement HMI and data logger, supporting Modbus TCP/RTU/ASCII master and MQTT protocols. (See more...)

Hardware Features

- Powerful CPU Module
 - E3845 (1.91 GHz, 64-bit quad core) for XP-9181-IoT/ XP-9381-IoT/ XP-9781-IoT

- Memory Size:
 - SDRAM (2 GB DDR3) for XP-9181-IoT/ XP-9371-IoT/ XP-9771-IoT
 - SDRAM (4 GB DDR3) for XP-9181-IoT/ XP-9381-IoT/ XP-9781-IoT
 - Flash (64 GB SSD) for XP-9181-IoT/ XP-9371-IoT/ XP-9771-IoT/ XP-9181-IoT/ XP-9381-IoT/ XP-9781-IoT
 - CF Card (support up to 32 GB) for XP-9000-IoT
- 64-bit Hardware Serial Number
 - The 64-bit hardware serial number is unique and individual. Every serial number of AXP-9000-IoT PAC is different. Users can add a checking mechanism to their AP to prevent software from pirating.
- Rich I/O Expansion Ability
 - I/O Slots
 - RS-232/RS-485
 - FRnet
 - USB

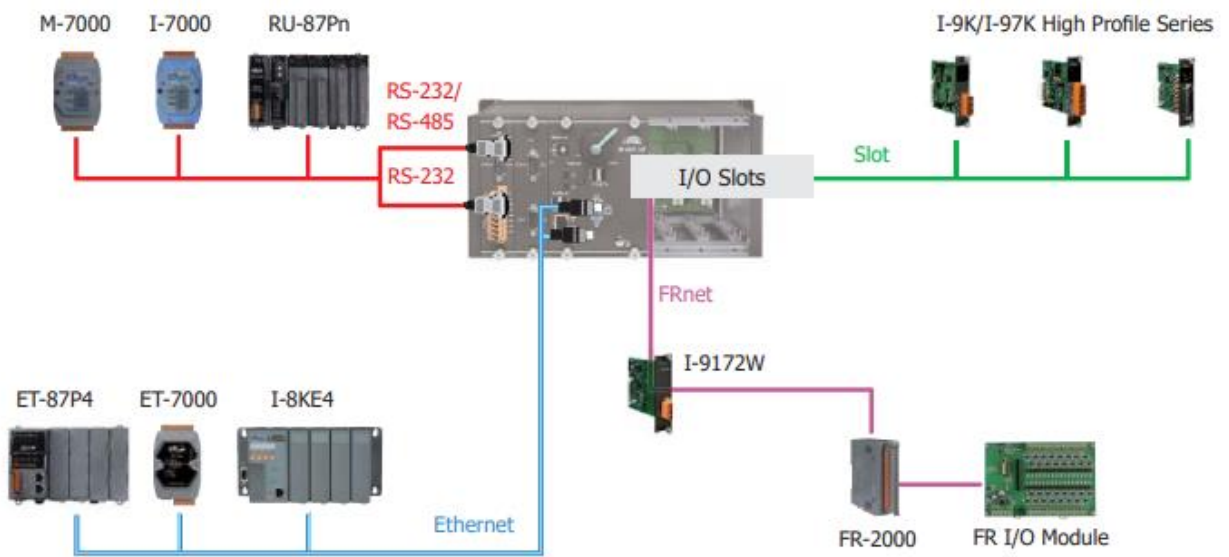

- Dual Ethernet Ports
 - XP-9000-IoT provides two Gigabit Ethernet ports. The two Ethernet ports can be used to implement redundant Ethernet communication and separate Ethernet communication (one for a global Internet, one for private Ethernet).

- Dual Watchdog Timer
 - A system could be hanged up when the OS or the AP fails. There are two watchdogs (CPU watchdog and Backplane watchdog) designed to automatically reset the CPU/Backplane when the situations happen. The design will increase the reliability of the system.
- Redundant Power Input
 - To prevent the XP-9000-IoT from failing by the power loss, the power module is designed with two inputs. The AXP-9000-IoT can keep working even one power input fails, and meanwhile, there is a relay output for informing the power failure.
 -
- Operating Temperature :
 - -25 °C to +60 °C for XP-9181-IoT/ XP-9381-IoT/ XP-9781-IoT
 - -25 °C to +75 °C for XP-9171-IoT/ XP-9371-IoT/ XP-9771-IoT

1.2. Specifications

The table below summarizes the specifications of XP-9x81-IoT.

Models	XP-9181-IoT	XP-9381-IoT	XP-9781-IoT
System Software			
OS	Windows 10 IoT Enterprise (64-bit)		
Framework Support	.Net Framework 3.5 ~ 4.8		
Embedded Service	IE11, FTP Server, IIS 7.0, ASP (Java Script, VB Script)		
SDK Provided	DII for VC, DII for Visual Studio.Net		
Multilanguage Support	English, German, French, Spanish, Portuguese, Russian, Italian, Korean, Japanese, Simplified Chinese, Traditional Chinese		
CPU Module			
CPU	E3845 (1.91 GHz, 64-bit quad core)		
SDRAM	4 GB DDR3		
MRAM	128 KB		
Flash(SSD)	mSATA slot with one 64 GB SSD		
EEPROM	16 KB		
Memory Expansion	CF socket with one 32GB CF card (support up to 32 GB)		
RTC (Real Time Clock)	Provide second, minute, hour, date, day of week, month, year		
64-bit Hardware Serial Number	Yes, for software copy protection		
Dual Watchdog Timers	Yes (0.8 second)		
Programmable LED Indicator	2 (L1, L2)		
Rotary Switch	Yes (0 ~ 9)		
VGA & Communication Ports			
VGA Resolution	1280 x 1024 to 1920 x 1080 (16 : 9) /640 x 480 to 1024 x 768 (4 : 3)		
Ethernet Port	RJ-45, 10/100/1000M Base-TX (Auto-negotiating, Auto MDI/MDI-X, LED indicators)		
USB 2.0	4		
COM1	Internal communication with the I-97K series modules in slots		
COM2	RS-232/485 (Rx/D, Tx/D and GND for RS-232; Data+, Data- for		

	RS-485); 3000 V _{DC} isolated		
COM3	RS-485 (Data+, Data-); 3000 V _{DC} isolated		
COM4	RS-232/485 (Rx, Tx, CTS, RTS and GND for RS-232; Data+, Data- for RS-485); 3000 V _{DC} isolated		
COM5	RS-232 (Rx, Tx, CTS, RTS, DSR, DTR, CD, RI and GND); 3000 V _{DC} isolated		
Audio	Mic-in and Earphone-out		
I/O Expansion Slot	1	3	7
Mechanical			
Dimensions (W x H x D, unit: mm)	239 x 164 x 133	300 x 164 x 133	422 x 164 x 133
Installation	Wall mounting / DIN-rail mounting		
Environmental			
Operating Temperature	-25 °C to +60 °C		
Storage Temperature	-30 °C to +80 °C		
Ambient Relative Humidity	10 % to 90 % RH (non-condensing)		
Power			
Input Range	+10 V _{DC} to +30 V _{DC}		
Isolation	1 kV		
Redundant Power Inputs	Yes, with one power relay (1 A @ 24 V _{DC}) for alarm		
Capacity	4.1 A, 5 V supply to CPU and backplane, 2.5 A, 5 V supply to I/O expansion slots, 33 W in total	4.2 A, 5 V supply to CPU and backplane, 2.4 A, 5 V supply to I/O expansion slots, 33 W in total	4.4 A, 5 V supply to CPU and backplane, 2.2 A, 5 V supply to I/O expansion slots, 33 W in total
Consumption	18.5 W (0.77 A @ 24 V _{DC})	18.7 W (0.78 A @ 24 V _{DC})	20.4 W (0.85 A @ 24 V _{DC})

The table below summarizes the specifications of XP-9x71-IoT.

Models	XP-9171-IoT	XP-9371-IoT	XP-9771-IoT
System Software			
OS	Windows 10 IoT Enterprise (64-bit)		
Framework Support	.Net Framework 3.5 SP1, 4.0, 4.5		
Embedded Service	IE11, FTP Server, IIS 7.0, ASP (Java Script, VB Script)		
SDK Provided	DII for VC, DII for Visual Studio.Net		
Multilanguage Support	English, German, French, Spanish, Portuguese, Russian, Italian, Korean, Japanese, Simplified Chinese, Traditional Chinese		
CPU Module			
CPU	E3827 (1.75 GHz, 64-bit dual core)		
SDRAM	2 GB DDR3		
MRAM	128 KB		
Flash(SSD)	mSATA slot with one 64 GB SSD		
EEPROM	16 KB		
Memory Expansion	CF socket with one 32GB CF card (support up to 32 GB)		
RTC (Real Time Clock)	Provide second, minute, hour, date, day of week, month, year		
64-bit Hardware Serial Number	Yes, for software copy protection		
Dual Watchdog Timers	Yes (0.8 second)		
Programmable LED Indicator	2 (L1, L2)		
Rotary Switch	Yes (0 ~ 9)		
VGA & Communication Ports			
VGA Resolution	1280 x 1024 to 1920 x 1080 (16 : 9) /640 x 480 to 1024 x 768 (4 : 3)		
Ethernet Port	RJ-45, 10/100/1000M Base-TX (Auto-negotiating, Auto MDI/MDI-X, LED indicators)		
USB 2.0	4		
COM1	Internal communication with the I-97K series modules in slots		
COM2	RS-232/485 (RxD, TxD and GND for RS-232; Data+, Data- for RS-485); 3000 V _{DC} isolated		
COM3	RS-485 (Data+, Data-); 3000 V _{DC} isolated		

COM4	RS-232/485 (Rx/D, Tx/D, CTS, RTS and GND for RS-232; Data+, Data- for RS-485); 3000 V _{DC} isolated		
COM5	RS-232 (Rx/D, Tx/D, CTS, RTS, DSR, DTR, CD, RI and GND); 3000 V _{DC} isolated		
Audio	Mic-in and Earphone-out		
I/O Expansion Slot	1	3	7
Mechanical			
Dimensions (W x H x D, unit: mm)	239 x 164 x 133	300 x 164 x 133	422 x 164 x 133
Installation	Wall mounting /DIN-rail mounting		
Environmental			
Operating Temperature	-25 °C to +75 °C		
Storage Temperature	-30 °C to +80 °C		
Ambient Relative Humidity	10 % to 90 % RH (non-condensing)		
Power			
Input Range	+10 V _{DC} to +30 V _{DC}		
Isolation	1 kV		
Redundant Power Inputs	Yes, with one power relay (1 A @ 24 V _{DC}) for alarm		
Capacity	3.7 A, 5 V supply to CPU and backplane, 3.3 A, 5 V supply to I/O expansion slots, 35 W in total	3.8 A, 5 V supply to CPU and backplane, 3.2 A, 5 V supply to I/O expansion slots, 35 W in total	4.0 A, 5 V supply to CPU and backplane, 3.0 A, 5 V supply to I/O expansion slots, 35 W in total
Consumption	16.6 W (0.69 A @ 24 V _{DC})	16.8 W (0.7 A @ 24 V _{DC})	18 W (0.75 A @ 24 V _{DC})

1.3. Overview

The XP-9000-IoT Series modules are equipped with several interfaces and peripherals that can be integrated with external systems. Here is an overview of the components and its descriptions.

XP-9171-IoT/XP-9181-IoT

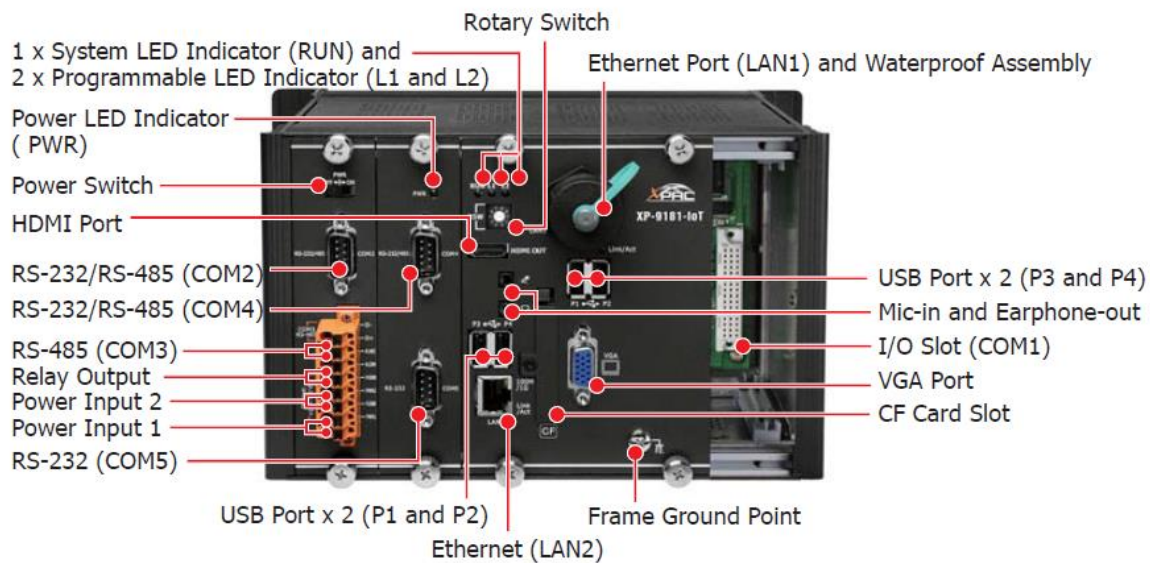

XP-9371-IoT/XP-9381-IoT

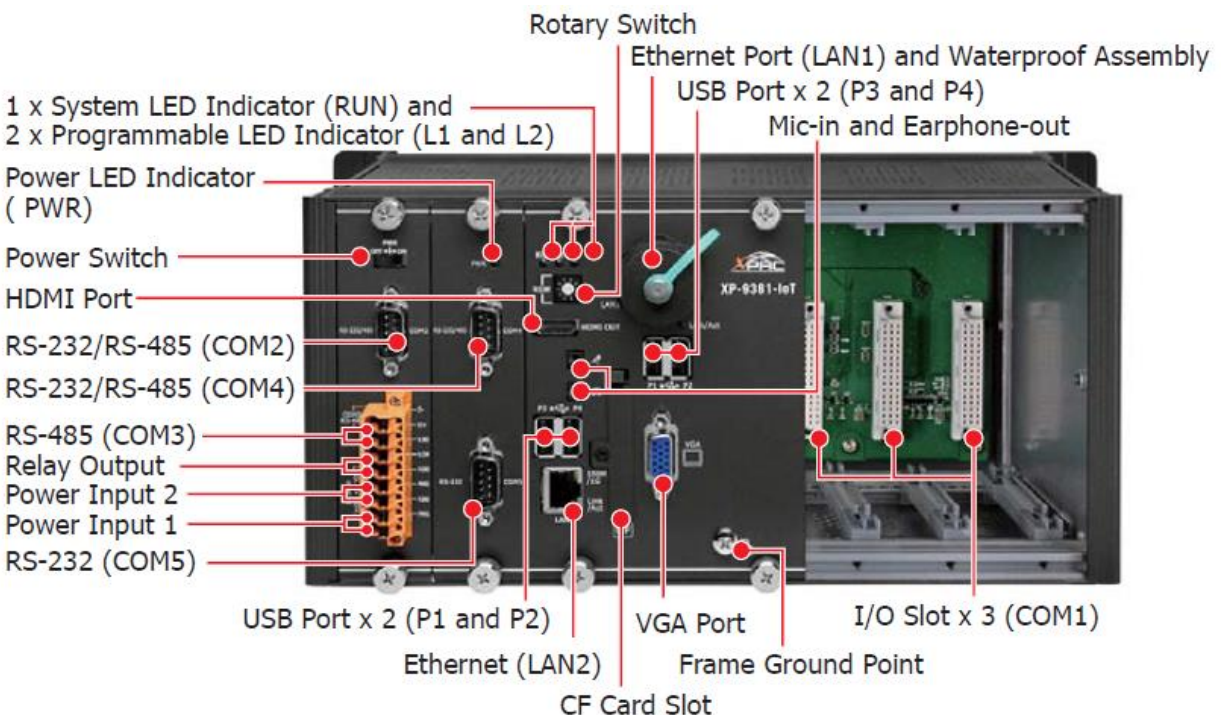

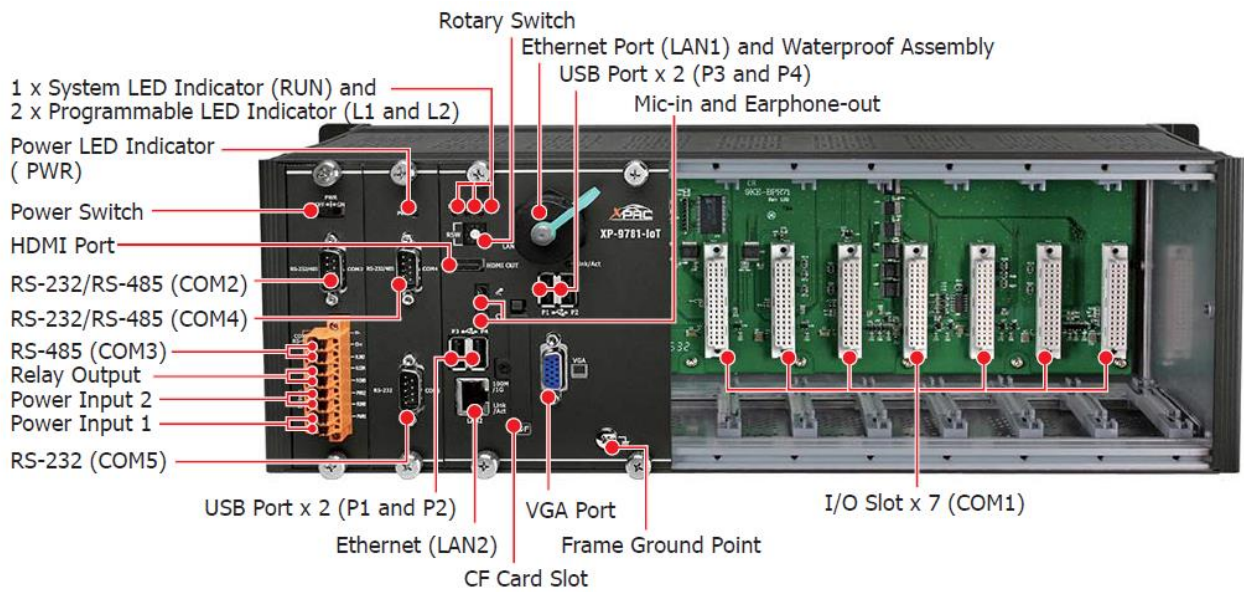

The details of these items are as follows:

Redundant Power (PWR1 and PWR2)

The XP-9000-IoT/AXP-9000-IoT has a terminal with 8-wire; there are 4-wire for redundant power inputs, the details of the redundant power are shown the side.

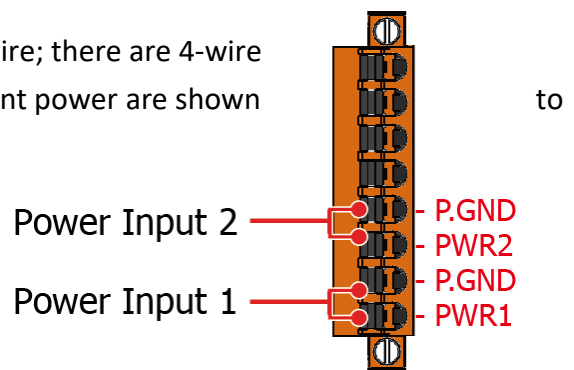

LED Indicators



LED Indicator	Label	State (Color)	Meaning
Programmable LED Indicators	L1 and L2	-	Programmable LED indicators
System LED indicator	RUN	Orange	OS is running
PWR LED Indicator	PWR	Green	Power is on
PWR LED Indicator	PWR	Green	Power is on
LAN1 LED indicator	Link/Act	Green	The Link is active
		Blinking	Network activity
LAN2 LED indicator	Link/Act	Green	The Link is active
		Blinking	Network activity
	1G	Orange	The network speed is 1 G

Communication Ports(XP-9000-IoT)

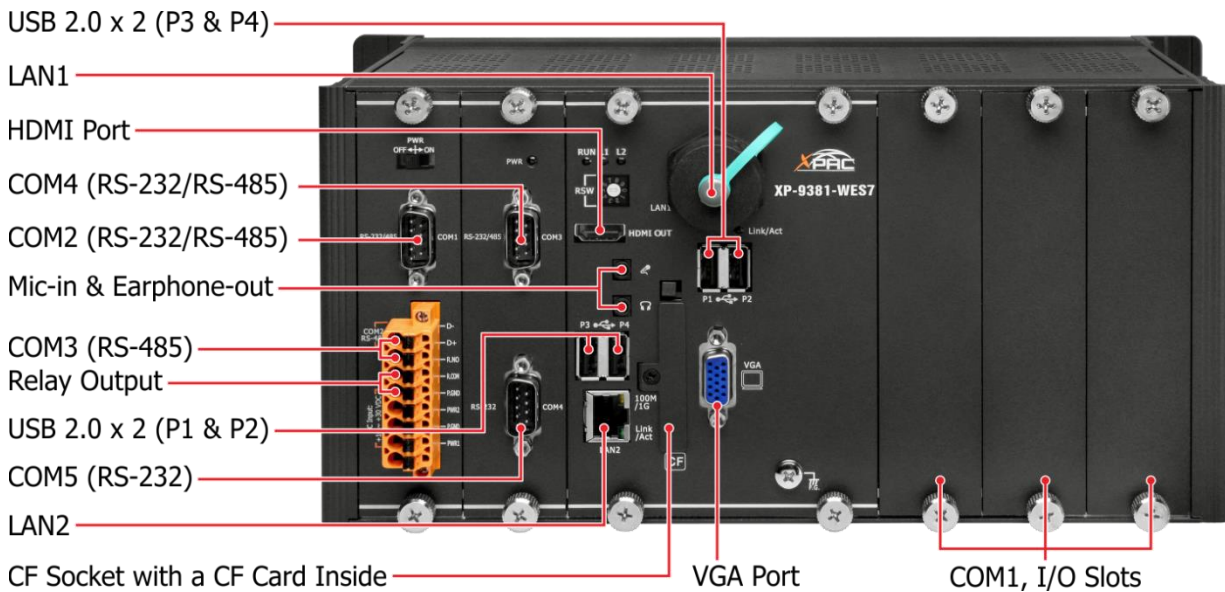

● CF Socket with a CF Card Inside

The XP-9000-IoT comes with a CF card inside the CF socket. The CF card can be used to restore the XP-9000-IoT system and expand the memory up to 32 GB.

● LAN Ports, LAN1 and LAN2

The XP-9000-IoT has two Ethernet ports that can be used to connect the router to the Internet or to other devices.

● USB 2.0 Ports, P1, P2, P3 and P4

The XP-9000-IoT has four USB 2.0 ports that can be used to connect the USB devices such as mouse, keyboard or an external USB hard drive.

● Mic-in and Earphone-out

The XP-9000-IoT has a microphone-in and an earphone-out that can be used to process the input and the output of sound.

- **Relay Output**

The XP-9000-IoT has a relay output that can be used to control a light, siren, or other low voltage device when an alarm occurs.

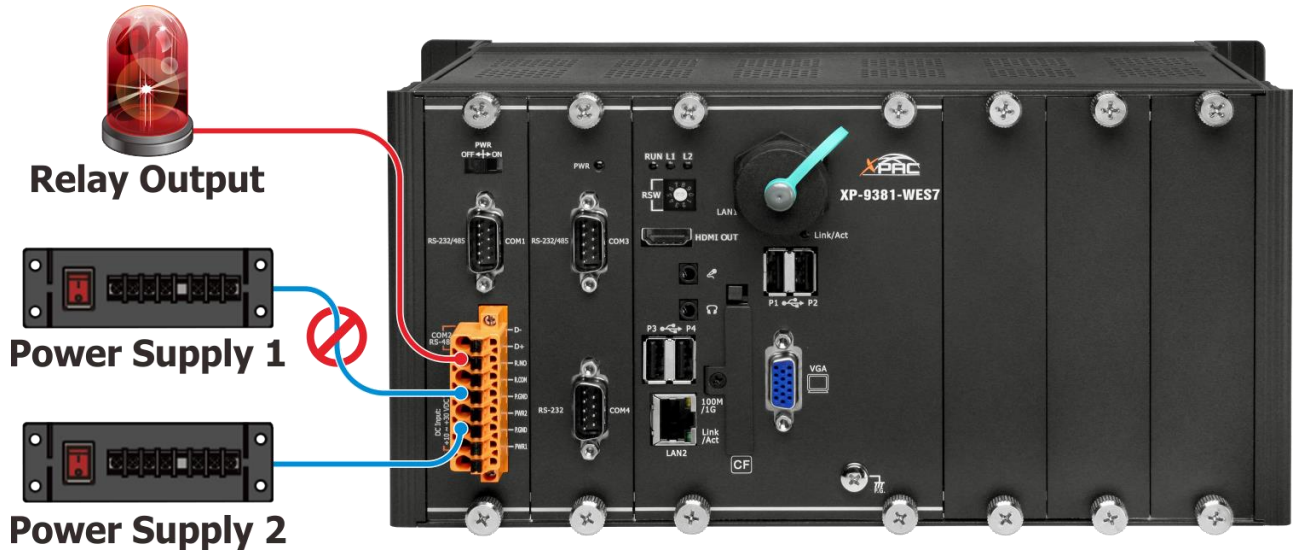

- **VGA Port**

The XP-9000-IoT has a VGA port that can be used with a variety of supported VGA resolutions, and the output resolution covers, 640 x 480, 800 x 600, 1024 x 768.

- **COM1, Expansion I/O Slot**

The XP-9000-IoT has 1/3/7 I/O slots that can be used to integrate high performance parallel I/O modules (I-9K Series) or serial I/O modules (I-97K series).

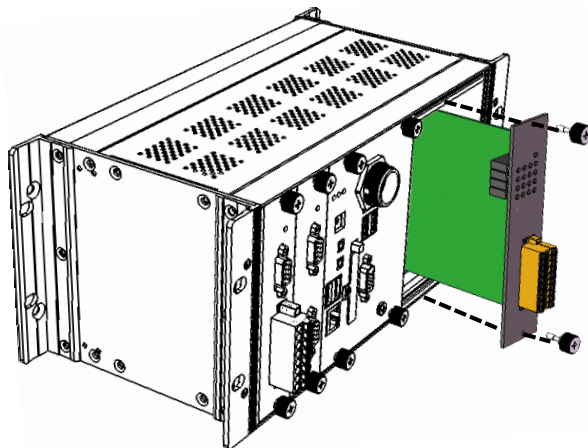

- **COM2 (RS-232/RS-485)**

The COM2 port is a 9-pins RS-232/RS-485 connector that can be configured as either RS-232 or RS-485, that only can select one at a time and its configuration depends on the pin connections as follows:

RS-232 (RXD, TXD and GND)

RS-485 (Data+ and Data-)

There is no software configuration or hardware jumper needed.

The details of the COM2 port specifications are shown to the side.

Note: 16C550 compatible

Port Type: Male

Baud Rate: 115200, 57600, 38400, 19200, 9600, 4800, 2400, 1200 bps

Data Bits: 5, 6, 7, 8

Parity: None, Even, Odd, Mark (Always 1), Space (Always 0)

Stop Bits: 1, 2

FIFO: 64 bytes

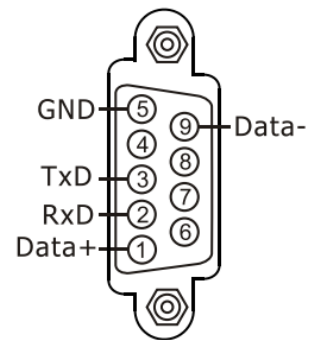

- **COM3 (2-wire RS-485)**

Note: 16C550 compatible

Port Type: Terminals

Baud Rate: 115200, 57600, 38400, 19200, 9600, 4800, 2400, 1200 bps

Data Bits: 5, 6, 7, 8

Parity: None, Even, Odd, Mark (Always 1), Space (Always 0)

Stop Bits: 1, 2

FIFO: 128 bytes

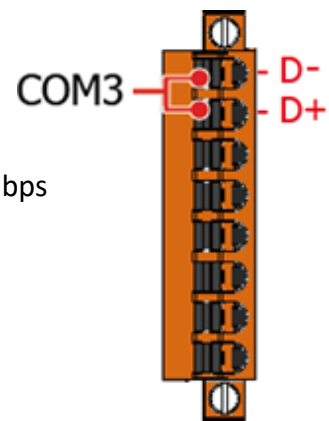

- **COM4 (RS-232/RS-485)**

The COM4 port is a 9-pins RS-232/RS-485 connector that can be configured as either RS-232 or RS-485, that only can select one at a time and its configuration depends on the pin connections as follows:

RS-232 (RXD, TXD, RTS, CTS and GND)

RS-485 (Data+ and Data-)

There is no software configuration or hardware jumper needed.

The details of the COM4 port specifications are shown to the side.

Note: 16C550 compatible

Port Type: Male

Baud Rate: 115200, 57600, 38400, 19200, 9600, 4800, 2400, 1200 bps

Data Bits: 5, 6, 7, 8

Parity: None, Even, Odd, Mark (Always 1), Space (Always 0)

Stop Bits: 1, 2

FIFO: 128 bytes

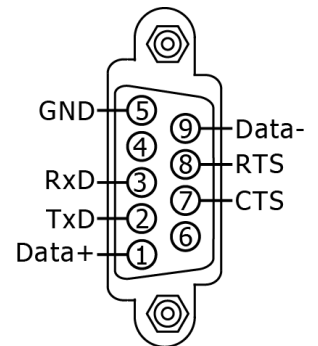

- **COM5 (RS-232)**

The COM5 port is a 9-pins RS-232 connector. The details of the COM5 port specifications are shown to the side.

Note: 16C550 compatible

Port Type: Male

Baud Rate: 115200, 57600, 38400, 19200, 9600, 4800, 2400, 1200 bps

Data Bits: 5, 6, 7, 8

Parity: None, Even, Odd, Mark (Always 1), Space (Always 0)

Stop Bits: 1, 2

FIFO: 128 bytes

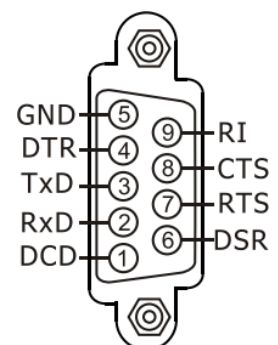

Tips & Warnings



The table below shows the data bit and their corresponding stop bit for COM2, COM3, COM4 and COM5.

Word Length	Number of Stop Bits
5, 6, 7, 8	1
5	1.5
6, 7, 8	2

Frame Ground Point

The frame ground point is a small piece of metal that can be used to terminate the shield.

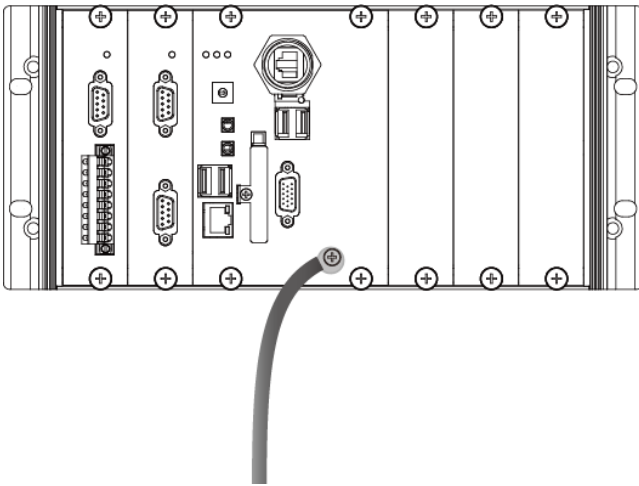

1.4. Dimensions

The diagrams below provide the dimensions of the XP-9000-IoT to use in defining your enclosure specifications. Remember to leave room for potential expansion if you are using other components in your system.

The height dimension is the same for all XP-9000-IoT. The width depending on your choose of I/O expansion slots. All dimensions are in millimeters.

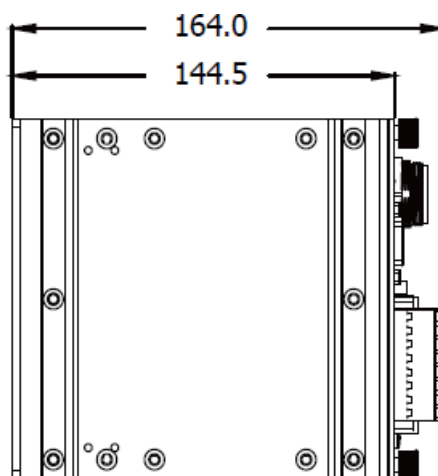

XP-9171-IoT/XP-9181-IoT

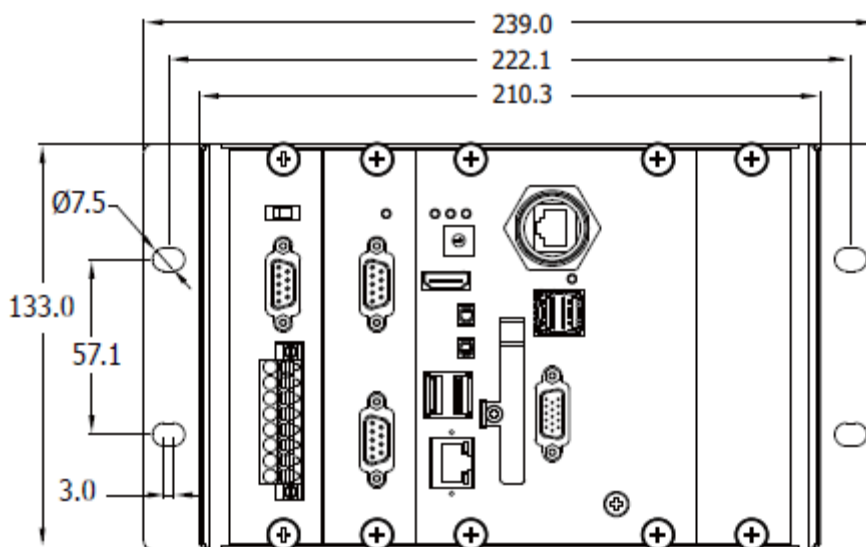

XP-9371-IoT/XP-9381-IoT

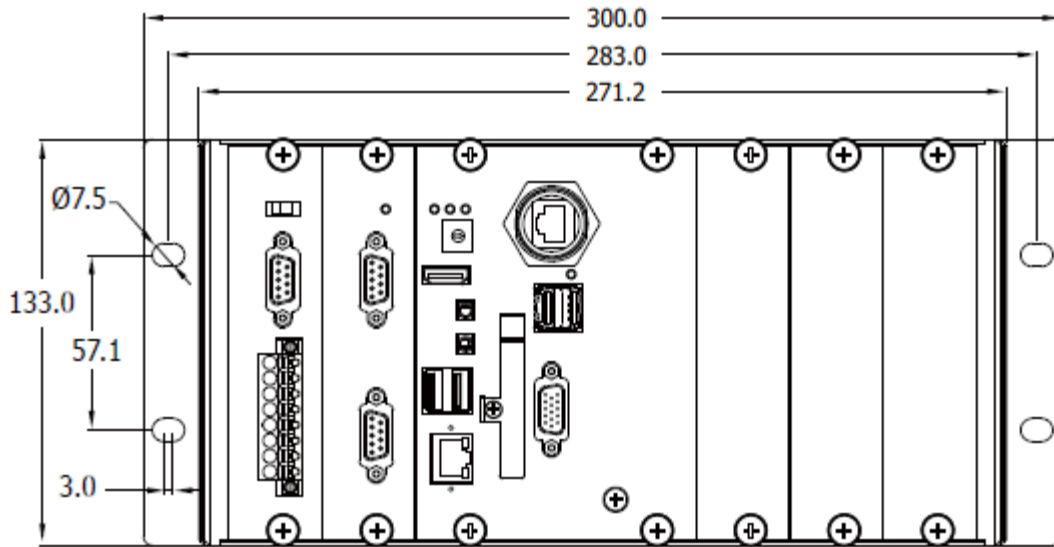

XP-9771-IoT/ XP-9781-IoT

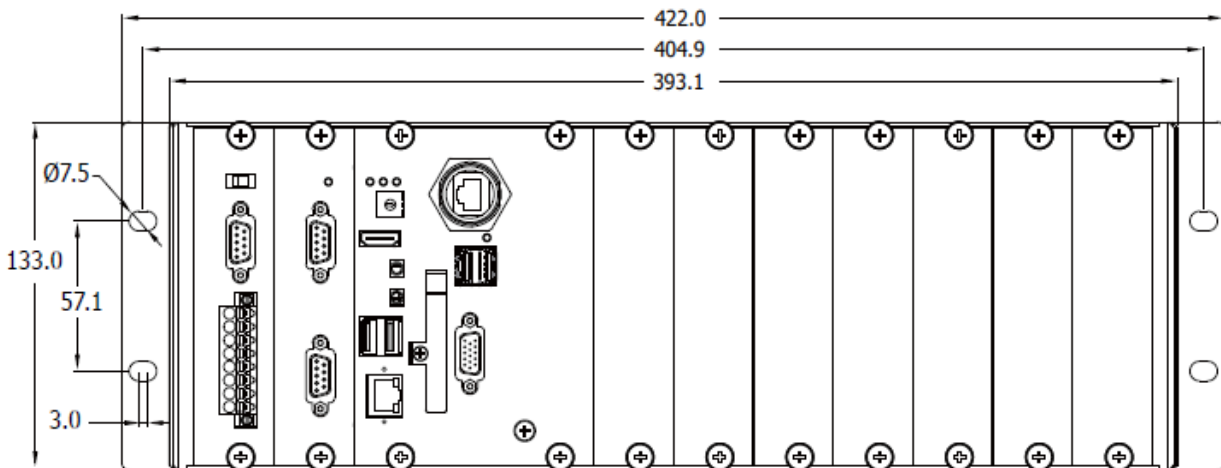

1.5. Rescue CF Card

The XP-9000-IoT comes with a rescue compact flash card that supports rescue mechanism for the XP-9000-IoT. All of them are listed below.

Rescue CF Card

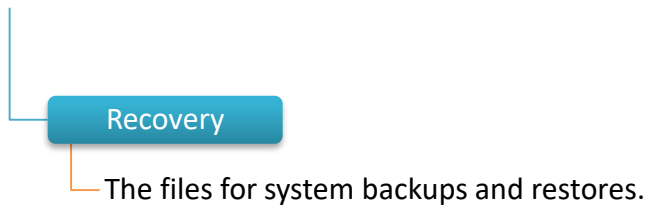

2. Getting Started

This chapter provides a guided tour of the XP-9000-IoT installation and configuration that describes the steps needed to download, install, configure, and run the basic procedures for user working with the XP-9000-IoT for the first time.

Before starting any task, please check the package contents. If any of the following package contents are missing or damaged, contact your dealer, distributor.

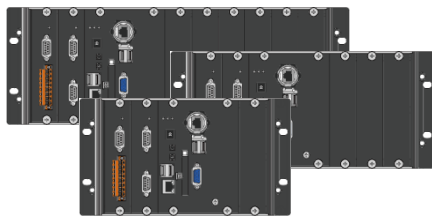

XP-91x1-IoT/XP-93x1-IoT/XP-97x1-IoT

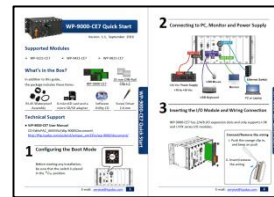

Quick Start Guide



RJ-45 Waterproof Assembly

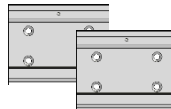

44 mm DIN-Rail Clip * 2



M3x6L Screw * 8



CF socket with one CF Card



**Screw Driver
(1C016) 2.4 mm**

2.1. Mounting the XP-9000-IoT

The XP-9000-IoT can be mounted either directly to a wall/panel, or onto a stainless 35mm DIN rail.

Wall/Panel mounting

Step 1: Install the four mounting screws into the 4 keyhole mounting holes

Step 2: Fasten the screws securely

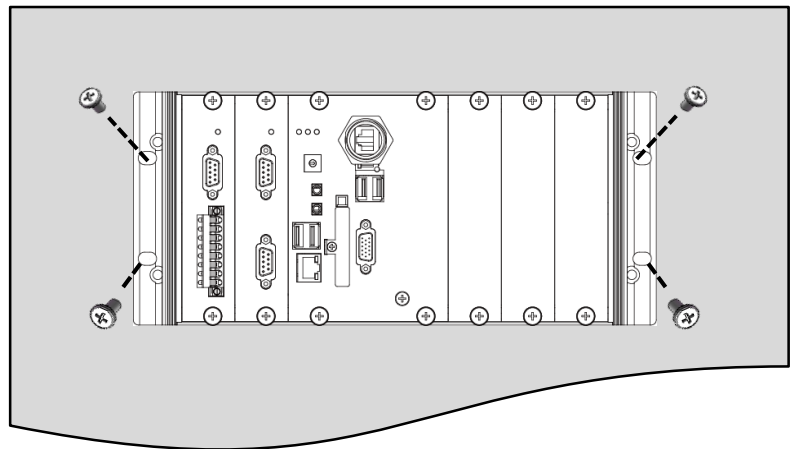

Tips & Warnings



There must be a minimum clearance of 50mm between the XP-9000-IoT and the top and bottom side of the enclosure panel.

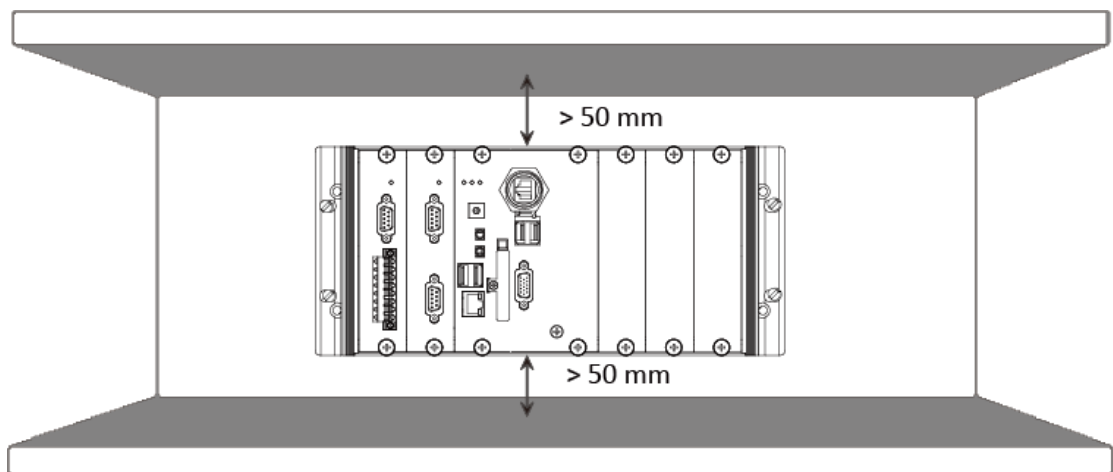

Step 3: Connect the ground lead to the frame ground point

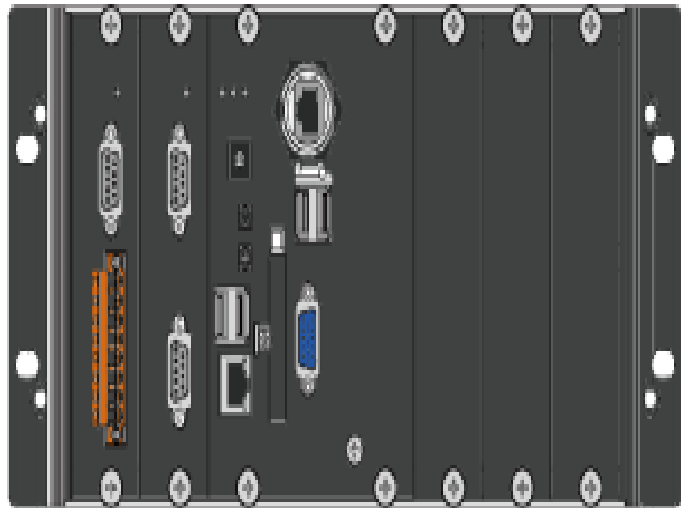

Tips & Warnings



A good common ground reference (earth ground) is essential for proper operation of the XP-9000-IoT. One side of all control circuits, power circuits and the ground lead must be properly connected to earth ground by either installing a ground rod in close proximity to the enclosure or by connecting to the incoming power system ground. There must be a single-point ground (i.e. copper bus bar) for all devices in the enclosure that require an earth ground.

DIN Rail mounting

Step 1: Fasten the DIN rail clip to the XP-9000-IoT

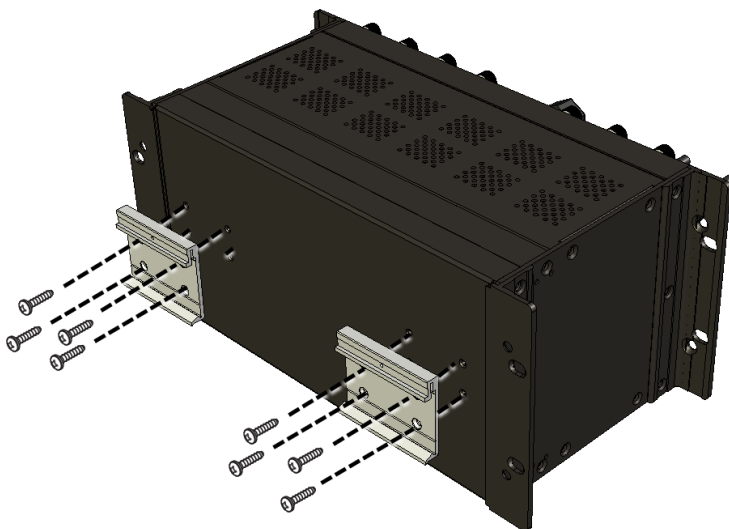

Step 2: Clip the device onto a stainless DIN rail

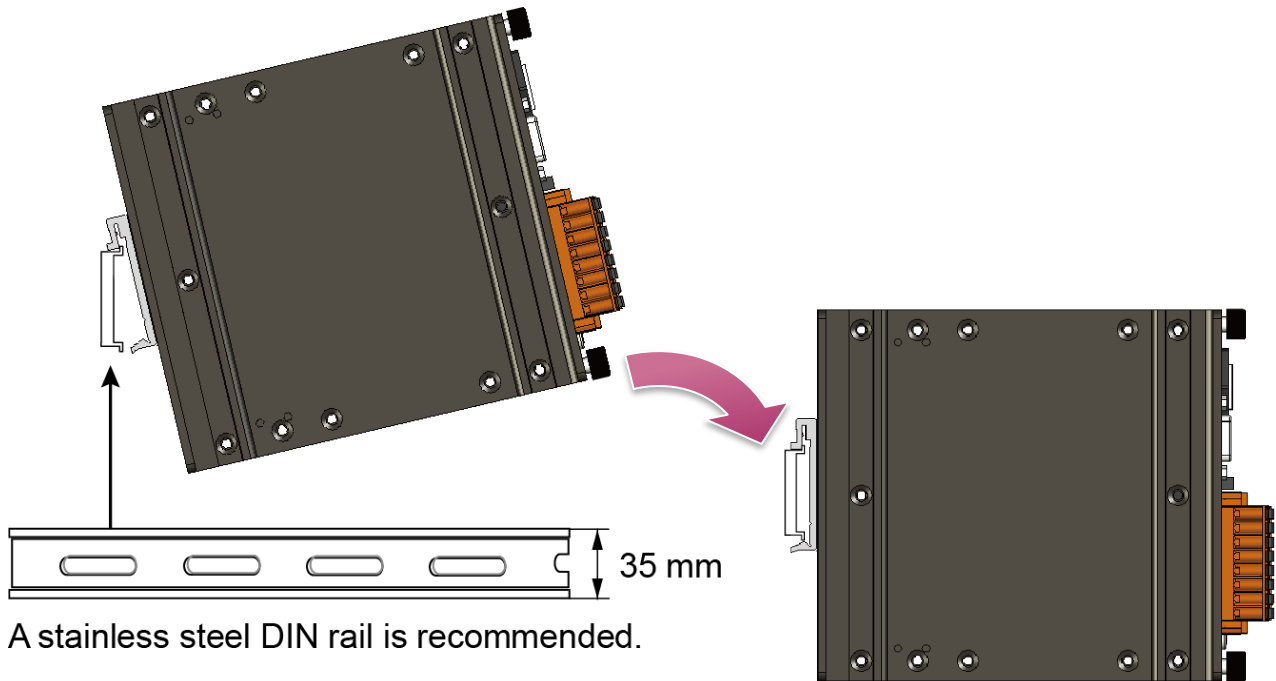

Tips & Warnings



For DIN rail mounting, it is strongly recommended that only a stainless steel DIN rail be used to support the weight of XP-9000-IoT system, providing stability and preventing XP-9000-IoT from leaning

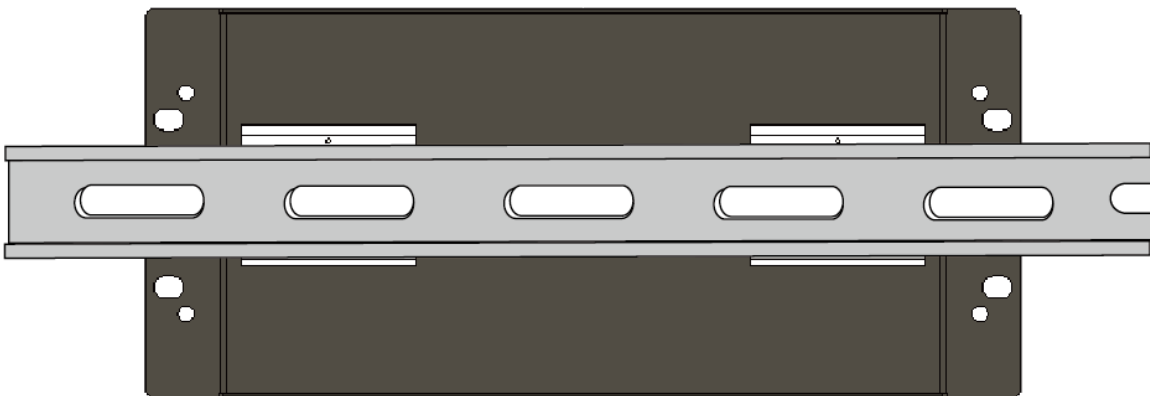

Step 3: Connect the ground lead to the frame ground point

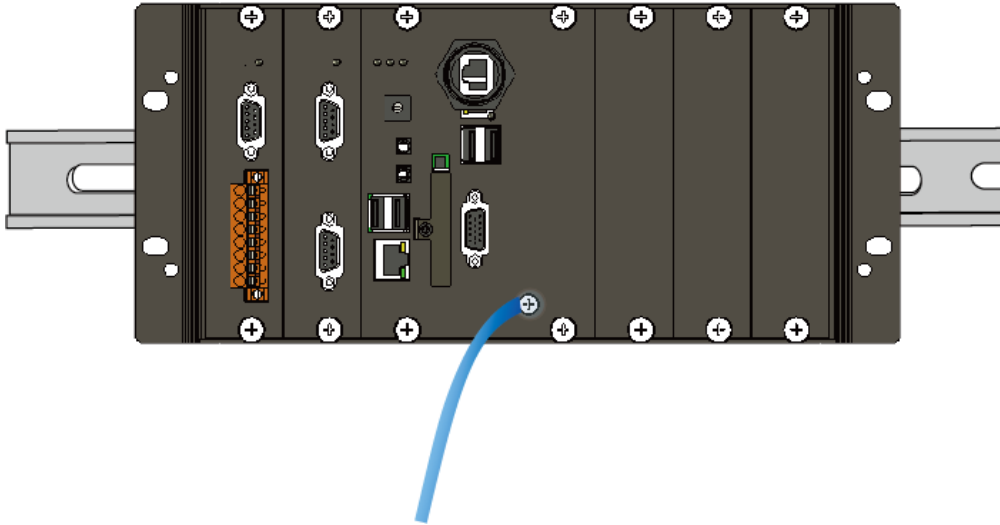

Tips & Warnings



A good common ground reference (earth ground) is essential for proper operation of the XP-9000-WES. One side of all control circuits, power circuits and the ground lead must be properly connected to earth ground by either installing a ground rod in close proximity to the enclosure or by connecting to the incoming power system ground. There must be a single-point ground (i.e. copper bus bar) for all devices in the enclosure that require an earth ground.

2.2. Installing the RJ-45 waterproof connector assembly

The XP-9000-IoT is equipped with an RJ-45 waterproof connector to protect the connection in vibrate environment.

The RJ-45 waterproof connector is optional for use with LAN1 port. If you do not need the RJ-45 waterproof connector, you can remove the cap and just plug in a regular Ethernet cable.

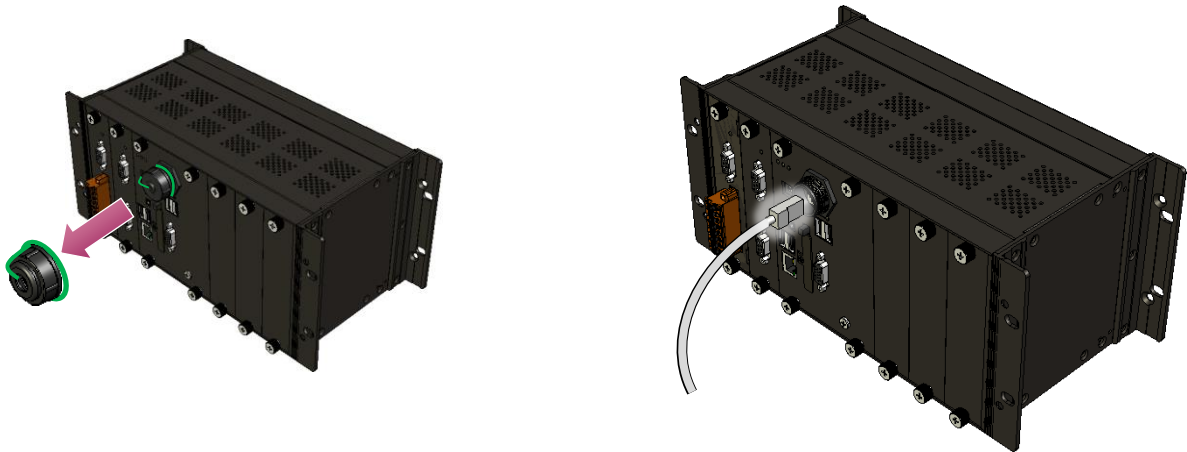

If you want to use the RJ-45 waterproof connector for protecting the connection, follow the instructions below.

Step 1: Remove the RJ-45 connector from the RJ-45 cable



Step 2: Feed the end of the RJ-45 cable through the (A) sealing nut, (B) rubber sealing insert, (C) cable gland base, (D) clamping ring and (E) panel gasket

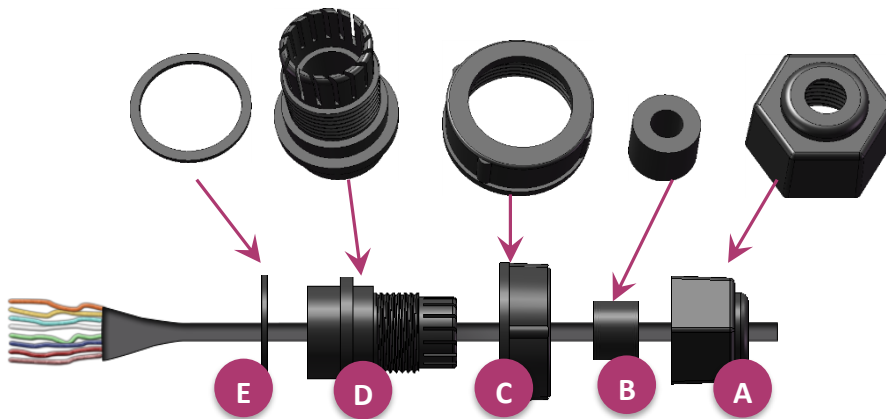

Step 3: Wrap the (E) panel gasket around the (D) clamping ring

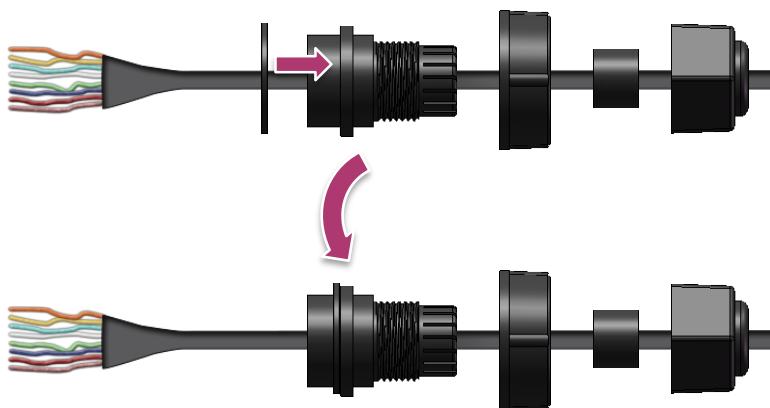

Step 4: Wrap the (C) cable gland base around the (D) clamping ring

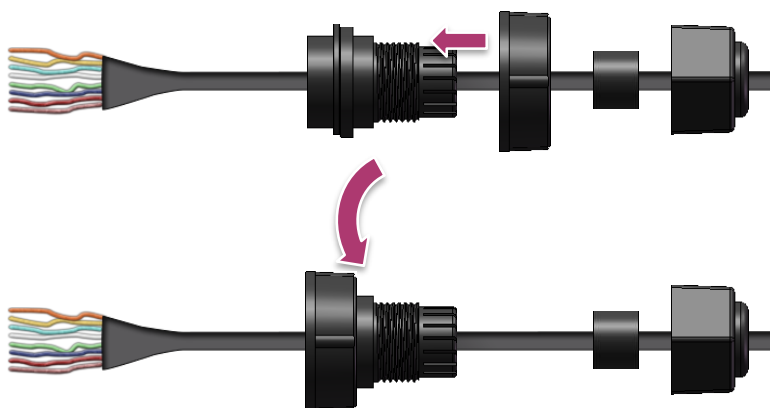

Step 5: Insert the (B) rubber sealing insert into the (D) clamping ring

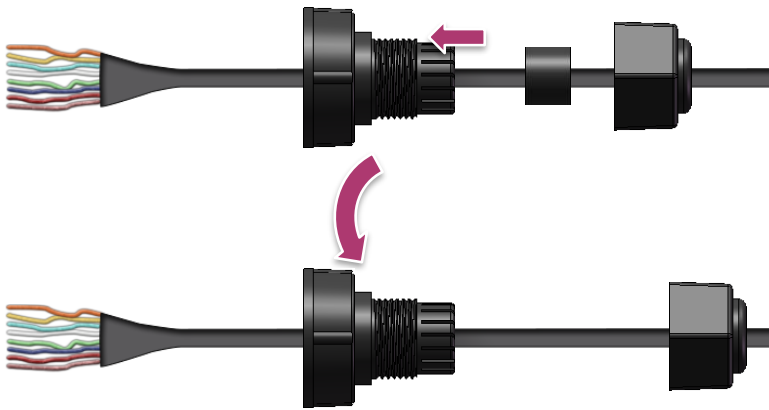

Step 6: Push the (E) sealing nut forward and Hand-tighten it to seal the assembly

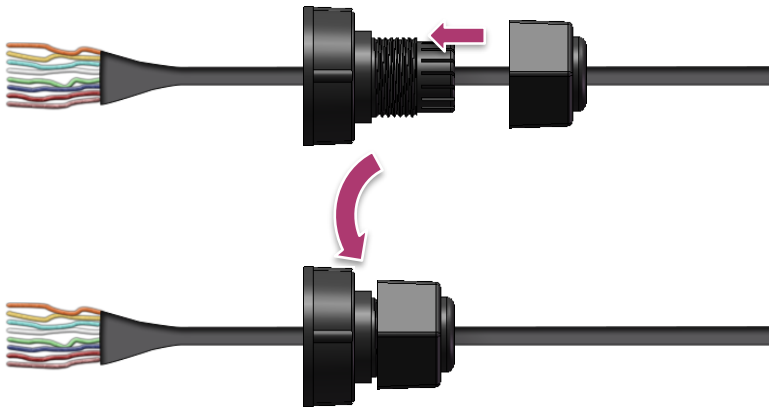

Step 7: Insert the RJ-45 cable into the RJ-45 connector

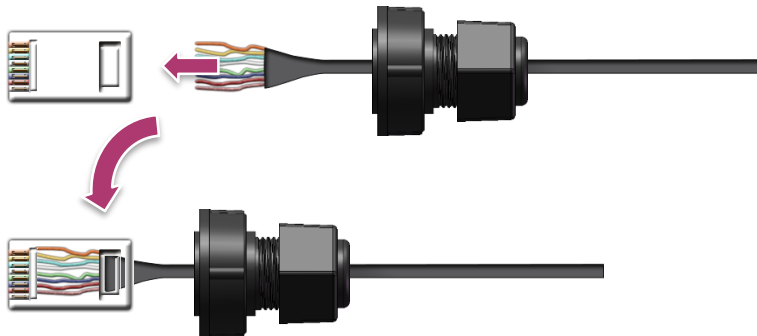

Step 8: Push the RJ-45 waterproof connector assembly forward



Step 9: Insert the Ethernet cable and screw the RJ-45 waterproof into the receptacle

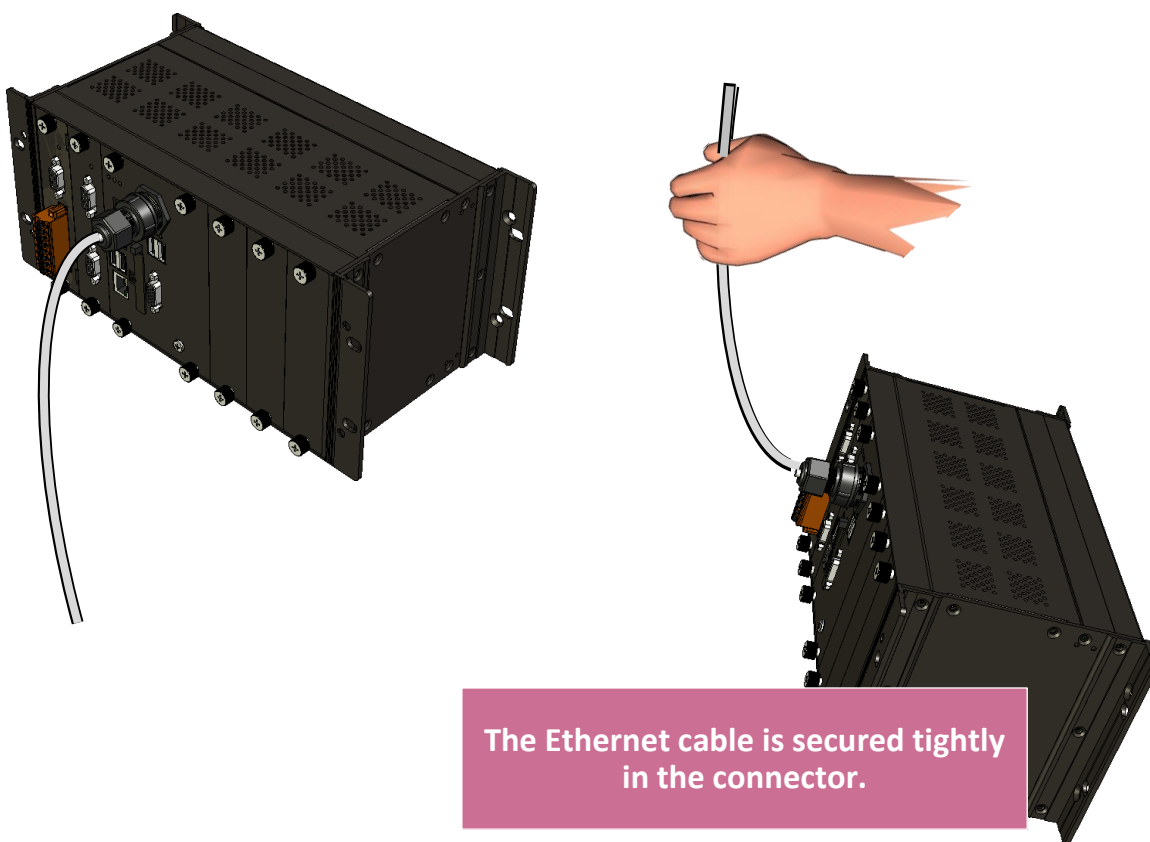

2.3. Deploying a Basic XP-9000-IoT System

The XP-9000-IoT provides a variety of communication interface to suit a range of application. Here is a simple application for using the XP-9000-IoT.

Step 1: Connect the positive terminal (+) of the power supply to the terminal PWR1/2 and the negative terminal (-) of the power supply to the P.GND

Tips & Warnings



1. The input range of power supply is +10 to +30 V_{DC}.
2. The XP-9000-IoT have two power inputs that can be connected simultaneously to the two independent power sources. If one power source fails, the other source takes over automatically. Redundant power input help assure non-stop operation of the XP-9000-IoT.

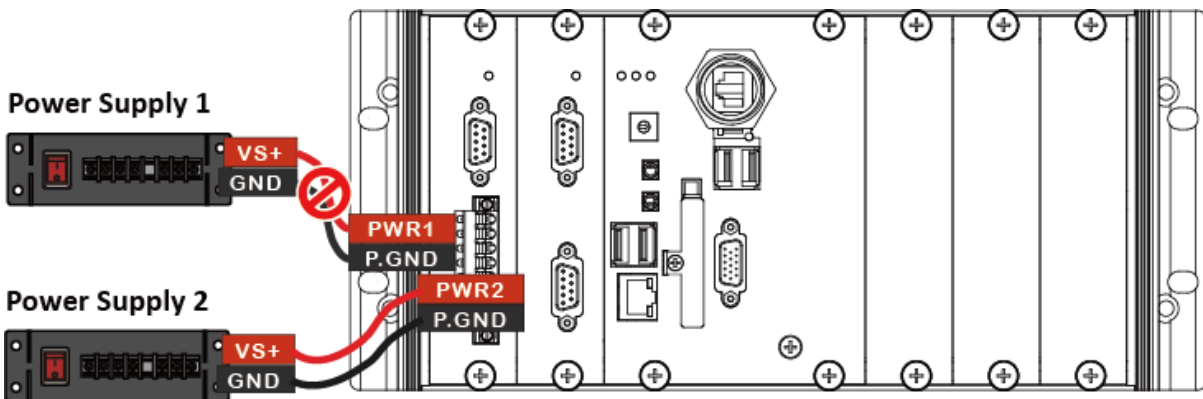

Step 2: Connect the USB mouse or the USB keyboard to the USB port

Step 3: Connect the monitor to the HDMI port or VGA port

Step 4: Connect to PC or the laptop to the LAN port via an Ethernet switch

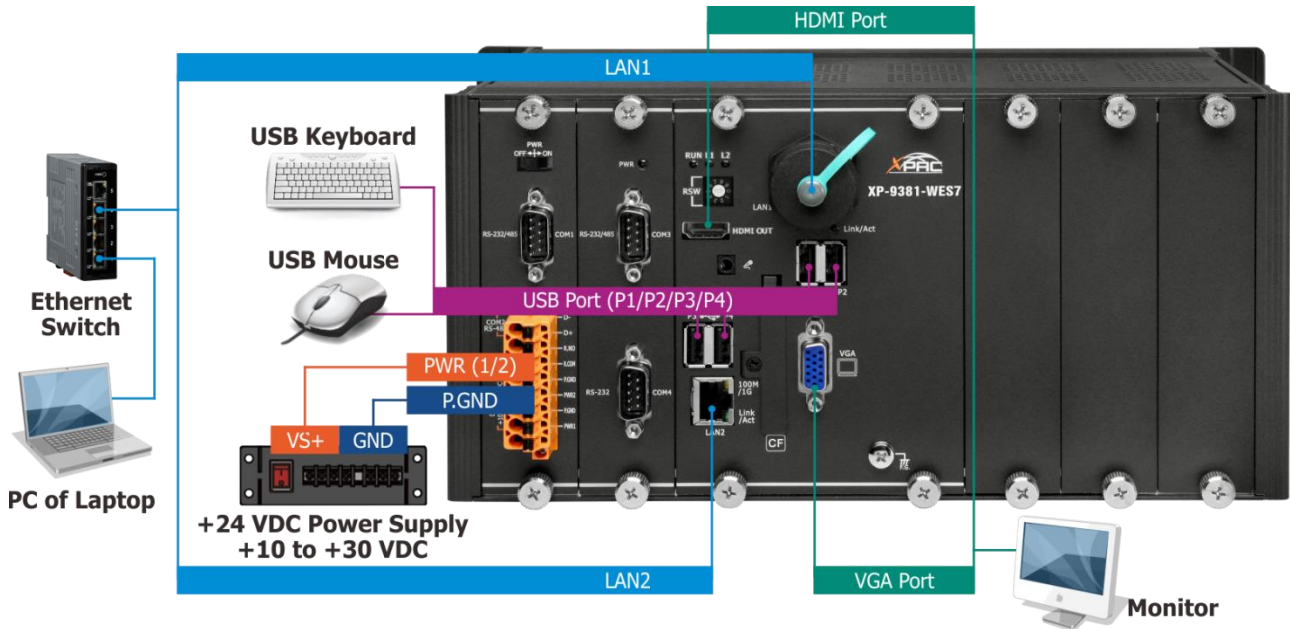

Tips & Warnings



The metal part of the cord end terminal on the wire can be direct wired to the terminal.

Remove the wiring from the terminal bloc

- i. Use the screwdriver to push the black clip in
- ii. Remove the wiring

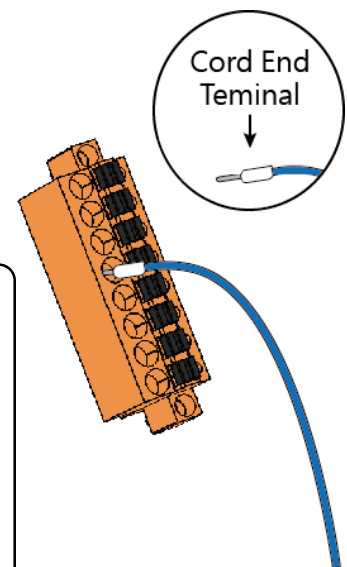
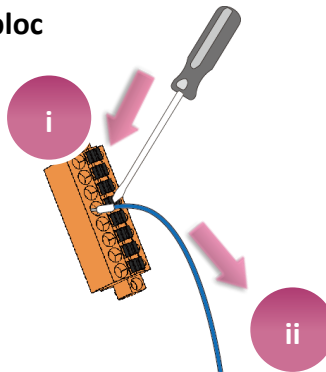

2.4. Inserting the I/O Modules

XP-9000-IoT has 1/3/7 I/O expansion slots to support I-9K and I-97K series I/O modules.

Before choosing the right I/O modules, you first need to know the I/O expansion capacities in order to choose the best expansion module for achieving maximal efficiency. For more information about the I/O expansion modules that are compatible with the XP-9000-IoT, please refer to:

[https://www.icpdas.com/en/product/guide+Remote I O Module and Unit+PAC %EF%BC %86+ Local I O Modules+I-9K I-97K Series](https://www.icpdas.com/en/product/guide+Remote+I+O+Module+and+Unit+PAC+%EF%BC%86+Local+I+O+Modules+I-9K+I-97K+Series)

Step 1: Insert the I/O module

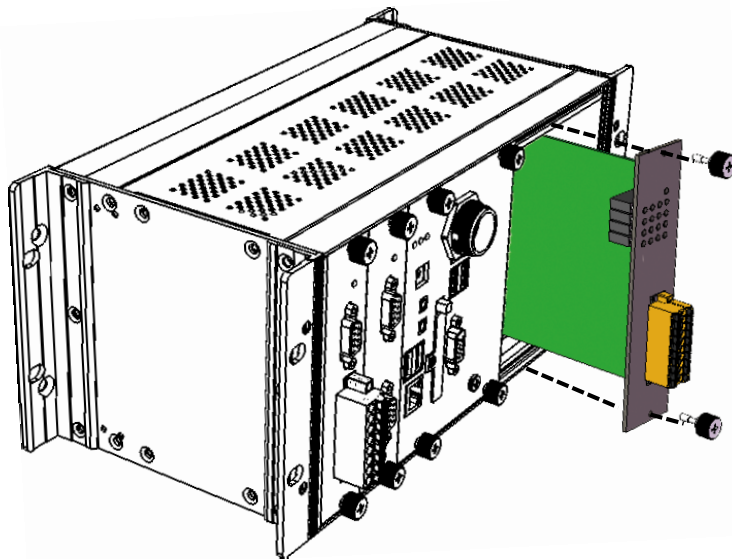

Step 2: Wiring connection

The metal part of the cord end terminal on the wire can be direct wired to the terminal of XP-9000-IoT.

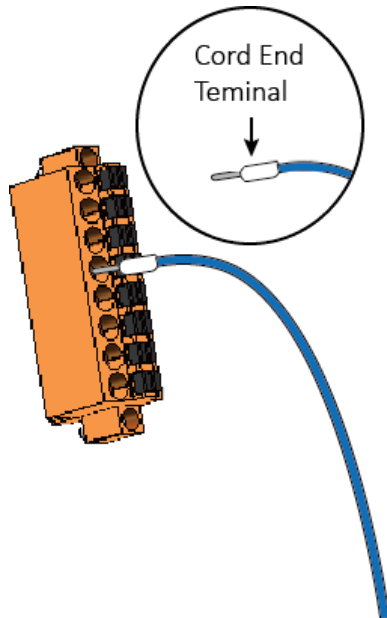

1. Use screwdriver to push the black clip in.

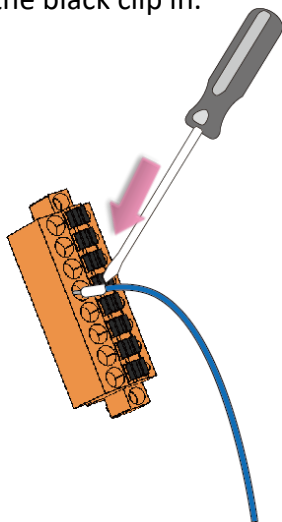

2. Remove the wiring from the terminal block

Keep on pushing

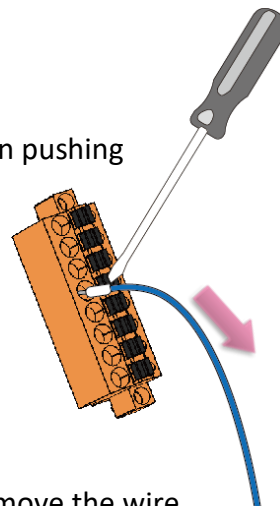

Remove the wire

Tips & Warnings



If you do not expand the I/O module full, please keep the top case of the unused slot to protect the backplane from dirt, dust and damage from foreign objects.

2.5. Unable UWF to Allow Settings to Be Saved

The UWF is a safety mechanism that provides the ability to control write protection of the XP-9000-IoT system built in C: drive. Any changes made to the system are lost when the start restarts while UWF is enabled, unless you unblock UWF then save the settings.

For more details about the UWF, please refer to section 3.4. Configuring the UWF Manager.

1. Click the PAC Utility shortcut on the desktop



2. Click the UWF Operation tab, select the Disable check box, and then click Apply button

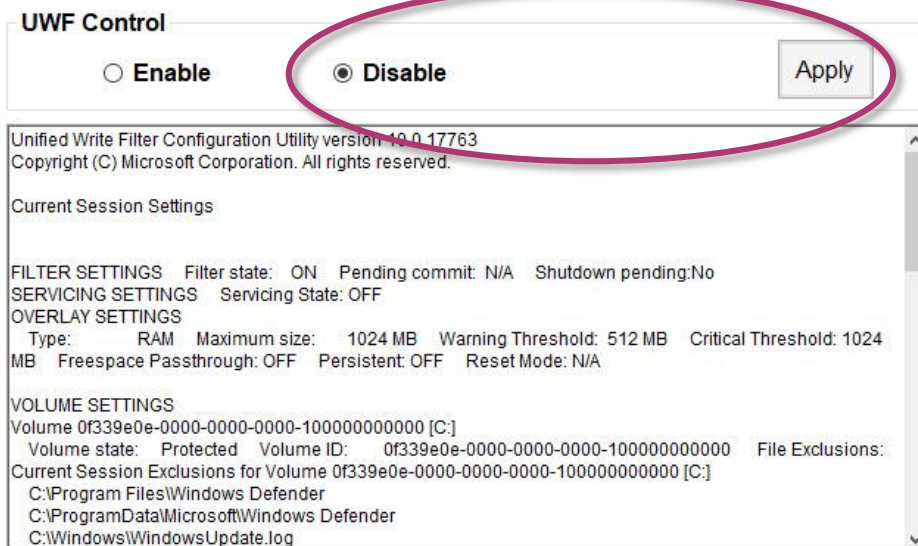
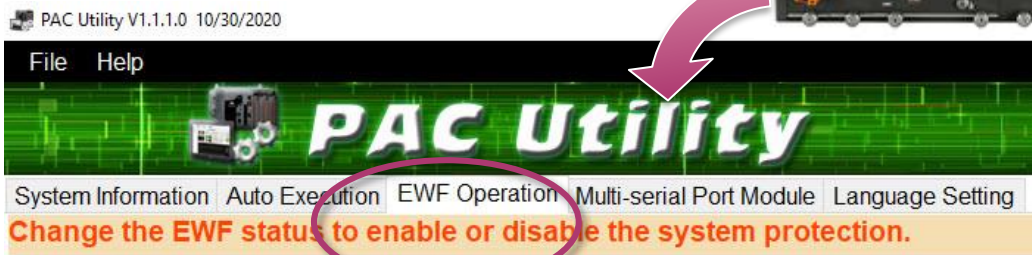





3. In the pop-up dialog box, click Yes button

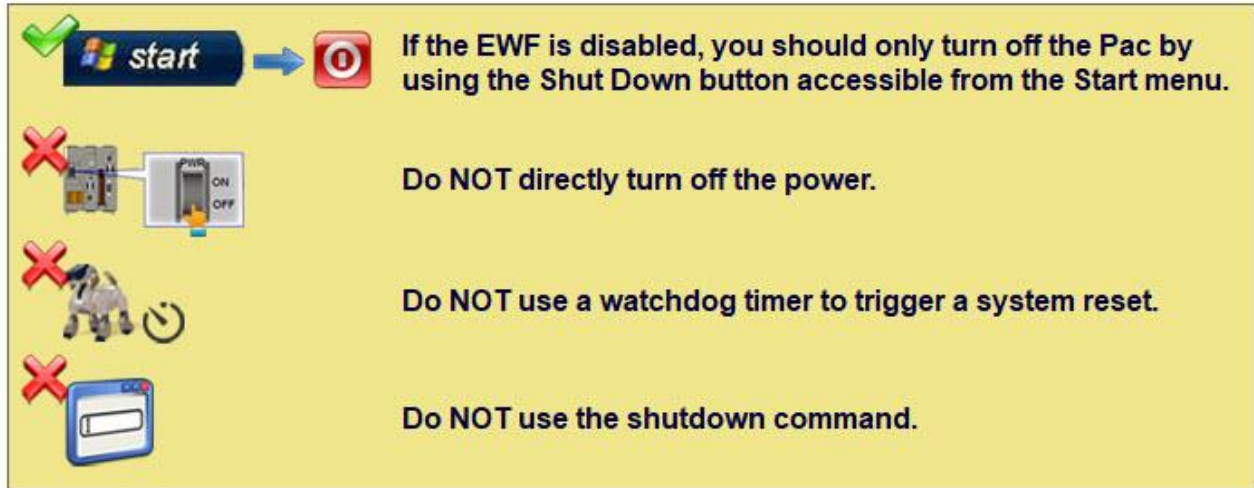

Disable EWF - Warning



 If the EWF is disabled, the OS will not be properly protected. In this situation, the OS should be shut down only by clicking the Start button and then clicking the Shut Down button in order to prevent the OS from being damaged.





  →  **If the EWF is disabled, you should only turn off the Pac by using the Shut Down button accessible from the Start menu.**

  **Do NOT directly turn off the power.**

  **Do NOT use a watchdog timer to trigger a system reset.**

  **Do NOT use the shutdown command.**

Are you sure you want to disable the EWF?

4. Click the Start button  , click the power button  , and then click Restart for changes to take effect.

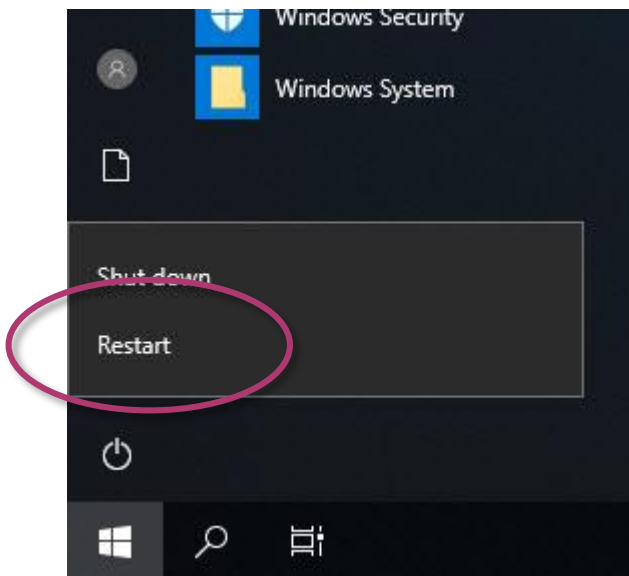

2.6. Using DCON Utility Pro to Configure I/O Modules

DCON Utility Pro is a tool kit designed to quickly control and manage I-97K series expansion I/O modules.

1. Click the DCON Utility Pro shortcut on the desktop



2. Click the Search  button

3. Click the module name to configure the I-97K series module



DCON Utility Pro V 3.1.0.2

Start Address: 1 End Address: 8 Search RU-87PN Addr. Mode

ID	Address	Baud Rate	Checksum	Format	Status	Description
9114	Slot1	-	-	-	Slot I/O	[9KIO]
97018	Slot2	115200	Disable	N,8,1	Slot I/O	[DCON]8*AI (mA,mV,V,Thermocouple)
9014	Slot3	-	-	-	Slot I/O	[9KIO]8/16*AI (mA,mV,V)

97018 Firmware[B402]

Configuration AI Commands Log About

Protocol (INIT*) DCON

Address 0 [00H]

Baud Rate (INIT*) 115200

Parity (INIT*) N,8,1-None Parity

Checksum (INIT*) Disable

Analog Format 2's Complement Form.

60/50 Hz 60Hz

Response Delay 0 ms

Set Module Configurations

Exit Save configurations to the file

Wait for loading 9114

3. Security and Risk

This chapter provides information of technological security risks and solutions associated with the XP-9000-IoT services.

Security is important for XP-9000-IoT. Based on Windows 10 IoT, XP-9000-IoT can avoid many security vulnerabilities. The following provides some security policy that you should consider before you develop your XP-9000-IoT.

- Windows Firewall
- IIS (Internet Information Service)
- UWF (Unified Write Filter)

The following table provides the default settings of the XP-9000-IoT security policy.

Security Item	Default Settings	User Name	Password
Firewall	Enable	N/A	N/A
IIS	Disable	anonymous	Blank
UWF	Enable	N/A	N/A

3.1. Creating and Managing User Accounts

Based on Windows 10 IoT, XP-9000-IoT includes several components for managing user account names, groups, and passwords.

- The Administrator Account component allows you to specify the password for the local Administrator account. You can only include one Administrator Account component in your configuration.
- The User Account component allows you to specify the user name, group, and password for a local user account. You must add a separate User Account component for each user in your configuration.
- Additional components are required if you want to provide end-user access to account settings, passwords, and display names in User Accounts in Control Panel.

To open the user accounts tool

1. Click the Start button , find Control Panel then click it.

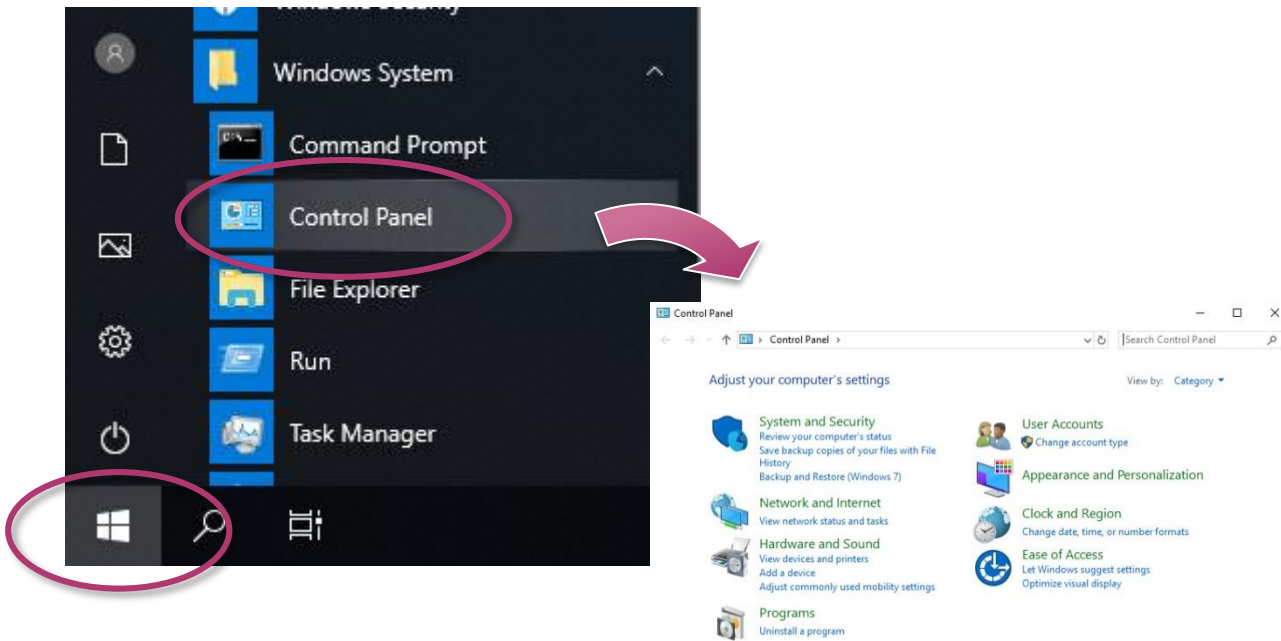

2. Click the User Accounts

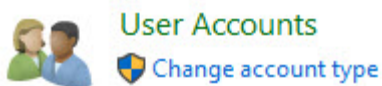

To create a new use account

1. Click user accounts

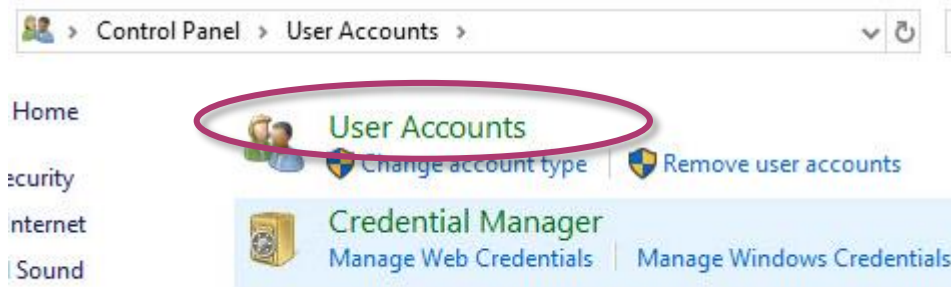

2. Click the Manage another account

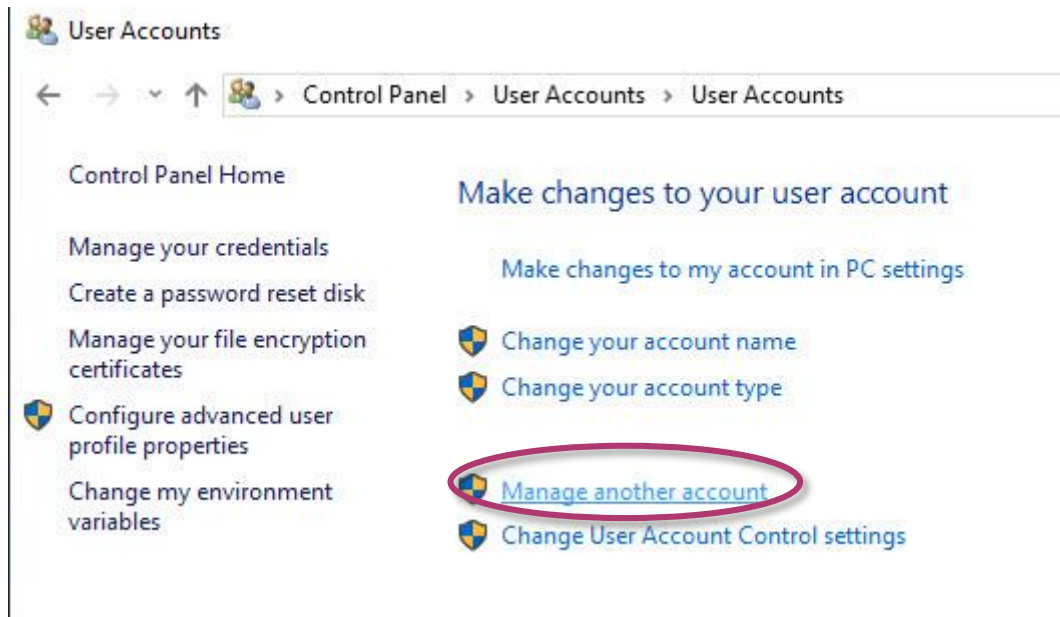

3. Click Add a user in PC settings

Choose the user you would like to change

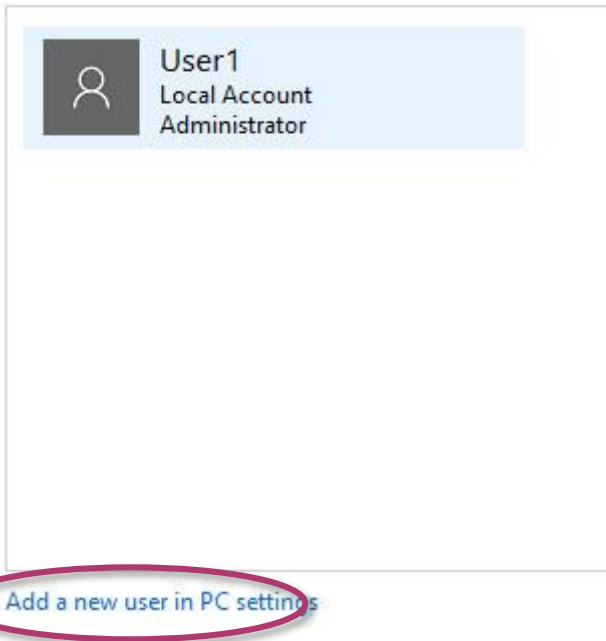

4. Click Add someone else to this PC

Family & other users

Your family

Sign in with a Microsoft account to see your family here or add any new members to your family. Family members get their own sign-in and desktop. You can help kids stay safe with appropriate websites, time limits, apps, and games.

[Sign in with a Microsoft account](#)

Other users

Allow people who are not part of your family to sign in with their own accounts. This won't add them to your family.

 **Add someone else to this PC**

Set up a kiosk



Assigned access

Set up this device as a kiosk—this could be a digital sign, interactive display, or public browser among other things.

5. Click I don't have this person's sign-in information

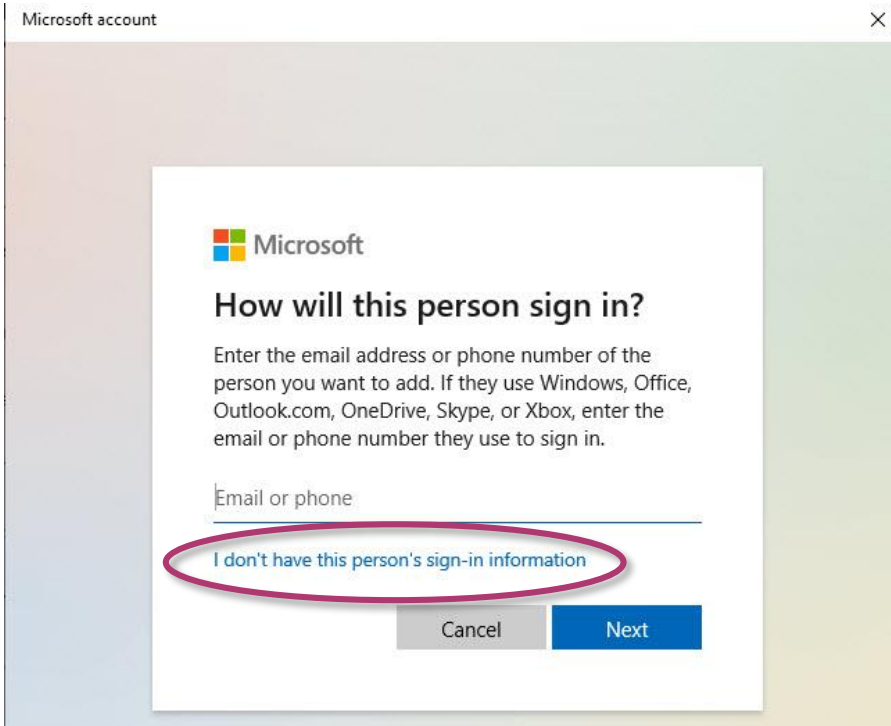

6. Click Add a user without a Microsoft account

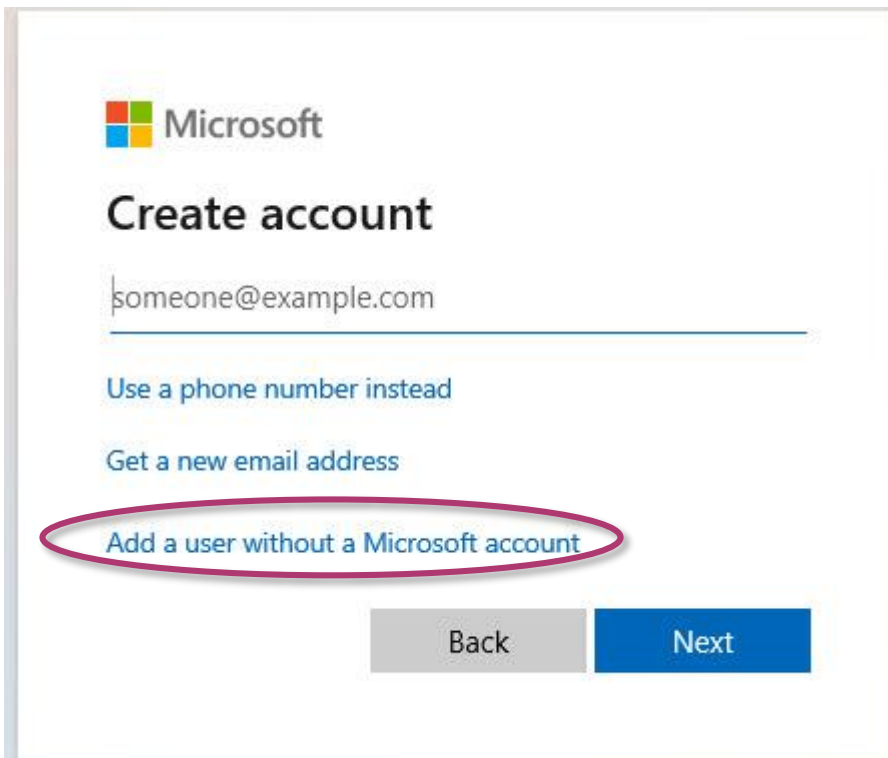

7. Type the name that you want to use for the account, if you want to set password, please enter it then click next.

Microsoft account ×

Create an account for this PC

If you want to use a password, choose something that will be easy for you to remember but hard for others to guess.

Who's going to use this PC?

User name

Make it secure.

Enter password

Re-enter password



Family & other users

Your family

Sign in with a Microsoft account to see your family here or add any new members to your family. Family members get their own sign-in and desktop. You can help kids stay safe with appropriate websites, time limits, apps, and games.

[Sign in with a Microsoft account](#)

Other users

Allow people who are not part of your family to sign in with their own accounts. This won't add them to your family.

+ Add someone else to this PC

 General User
Local account

Change account type Remove

To Make Changes to an Account

1. Back to Manage Accounts, click the account that you want to change.

Choose the user you would like to change

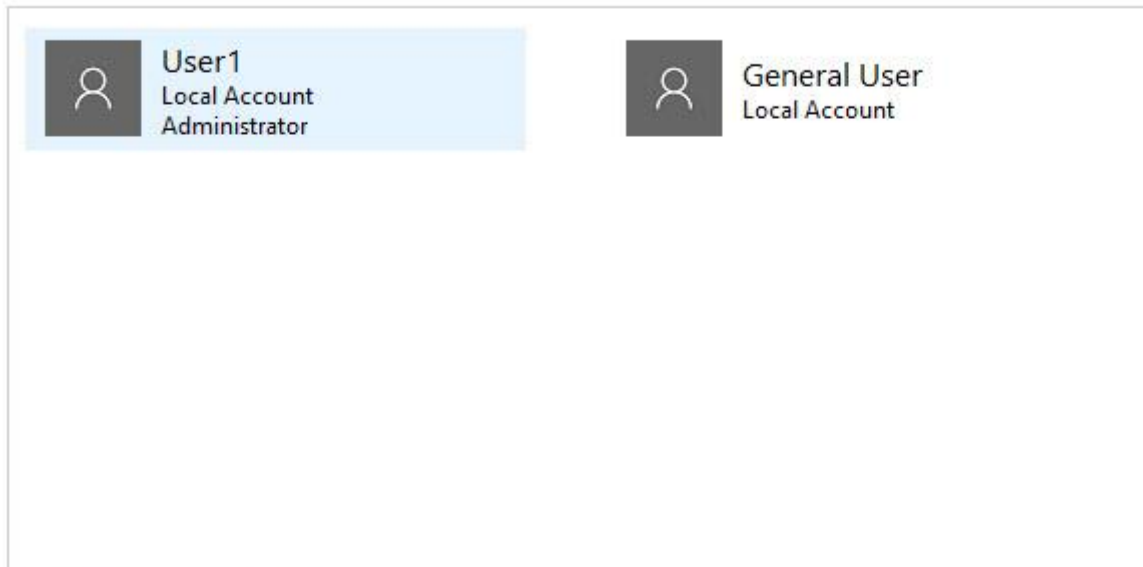

[Add a new user in PC settings](#)

2. Select the item that you would like to change:

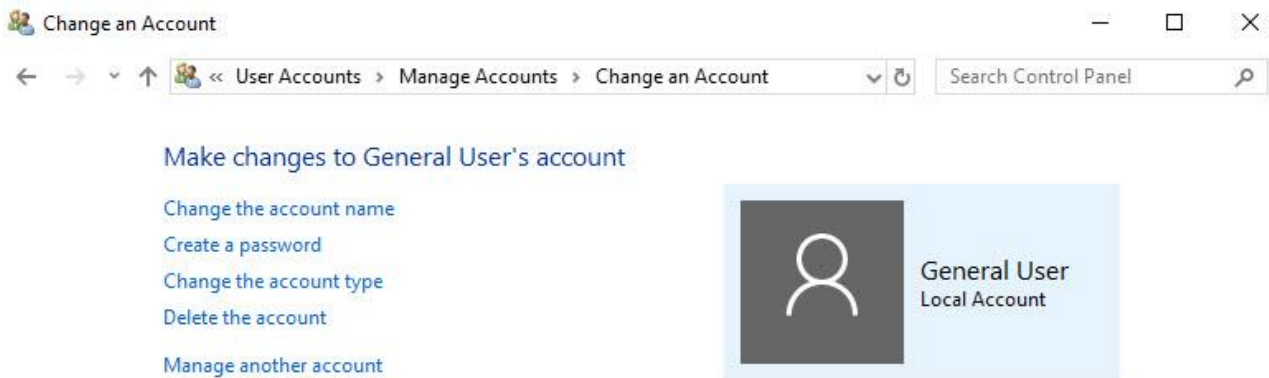

- Click the **Change the account name** to change the name that appears on the Welcome screen for the account.
- Click the **Create/change a password** to create or change the password for the user and create or change the password hint.
- Click the **Change the account type** to change the account type to increase or decrease the user's rights on the computer.
- Click the **Delete the account** to delete the user account from the computer. When you delete the account, you are given the option to save the user's files on the computer.
- Click the **Manage another account** to manage another account.

3.2. Turning Firewall On or Off

Based on Windows IoT, XP-9000-IoT Firewall with Advanced Security and the related firewall technologies documented here enable user to share Internet connections, protect connections using a firewall, and provide Network Address Translation (NAT).

To open the Windows Firewall tool

1. Click the Start button  , find Control Panel then click it.

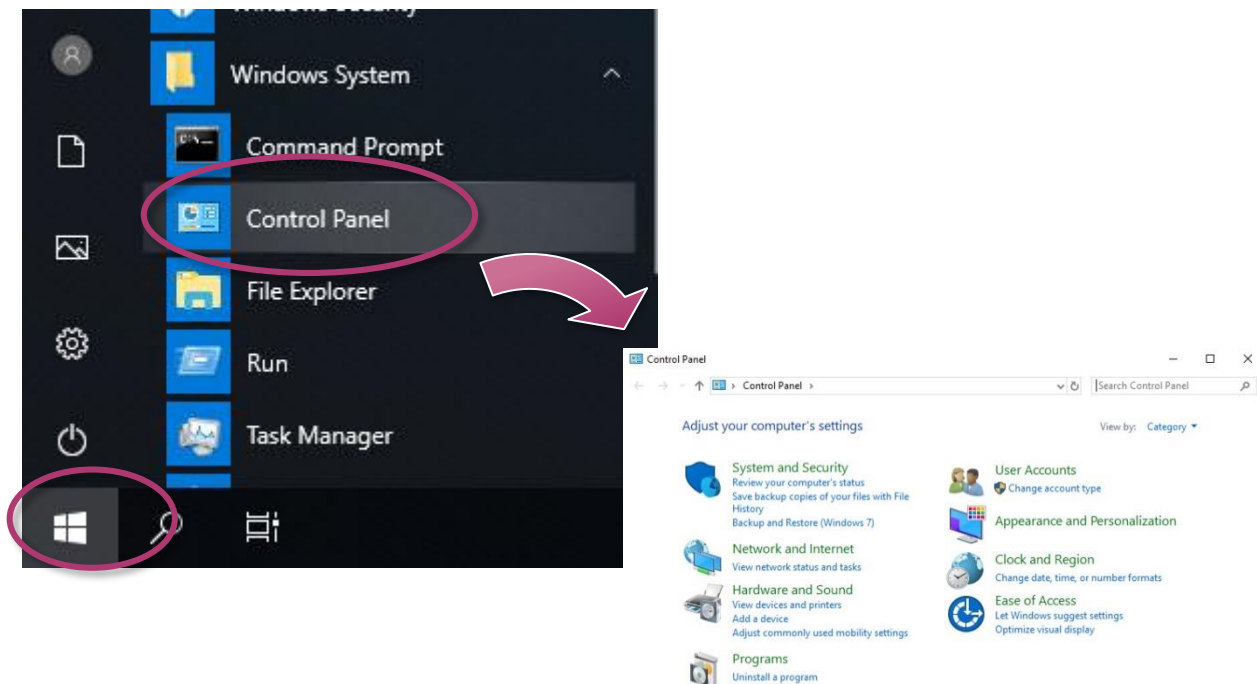

2. Click the System and Security, and then click Windows Defender Firewall



System and Security

Review your computer's status

Save backup copies of your files with File History

Backup and Restore (Windows 7)



Windows Defender Firewall

[Check firewall status](#) | [Allow an app through Windows Firewall](#)

To turn on/off Windows Firewall

1. Click the Turn Windows Firewall on or off in the left panel

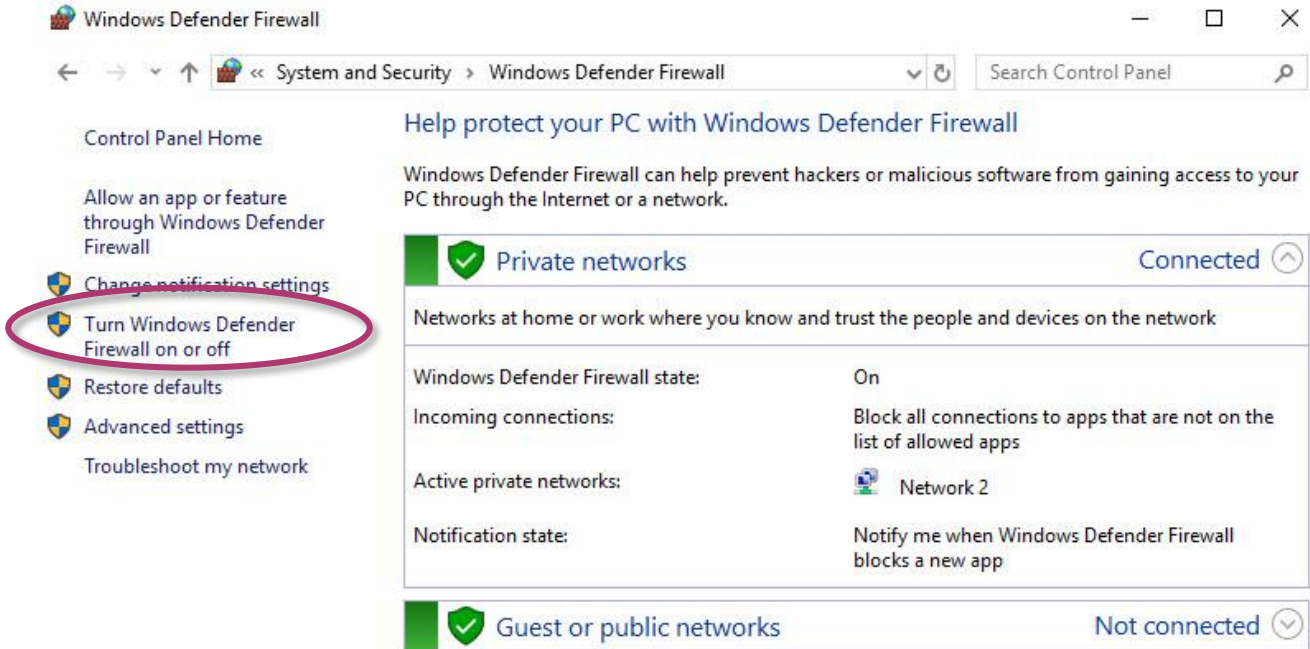

2. Select the settings for your home/work (private) or public network, and then OK

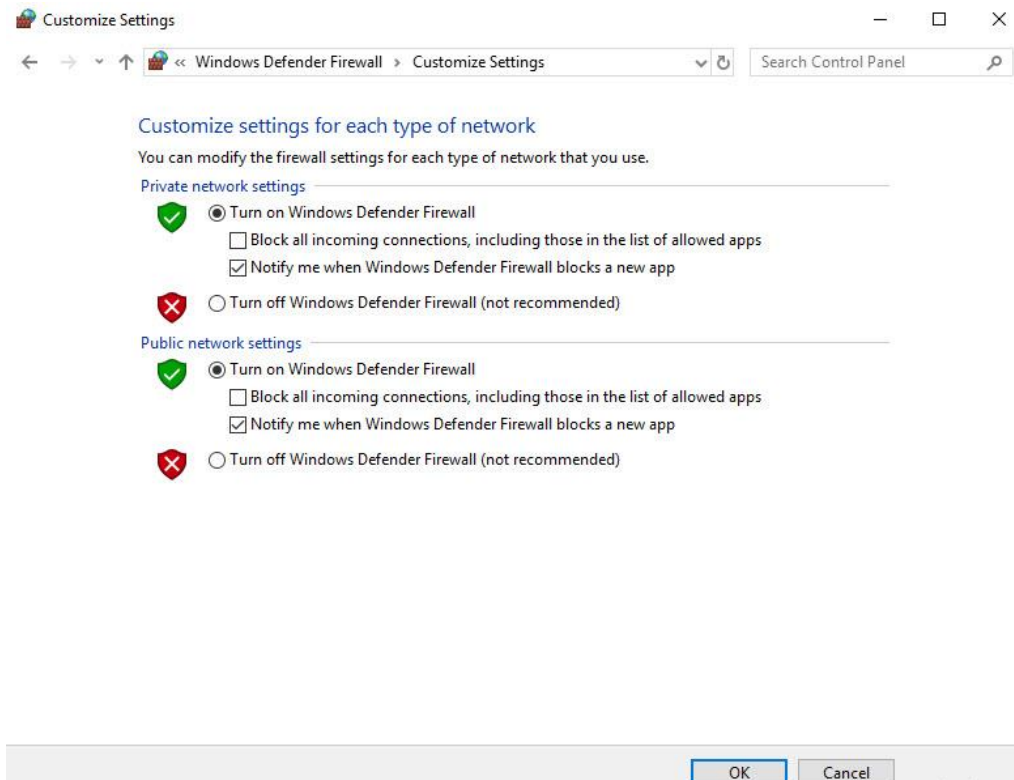

3.3. Configuring the FTP Server

Microsoft Internet Information Service (IIS) is installed in XP-9000-IoT and enabled as default. The IIS includes FTP Server and Web Server. It is convenient to use anonymous FTP access as default. However, it may cause some security problems too.

Tips & Warnings



If you can't set up the FTP server, this is probably caused by the firewall setting, turn the firewall off.

To configure the FTP Server

1. Click the Start button , search Control Panel then click it.

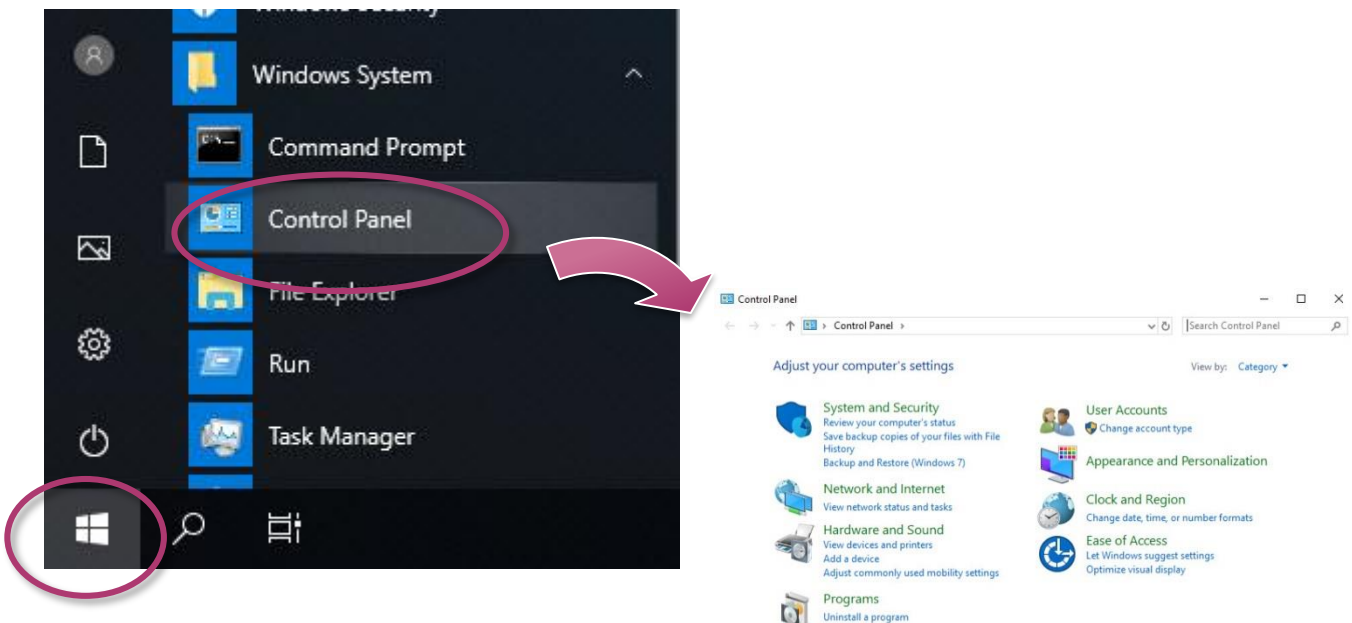

2. Click the System and Security, and then click Administrative Tools

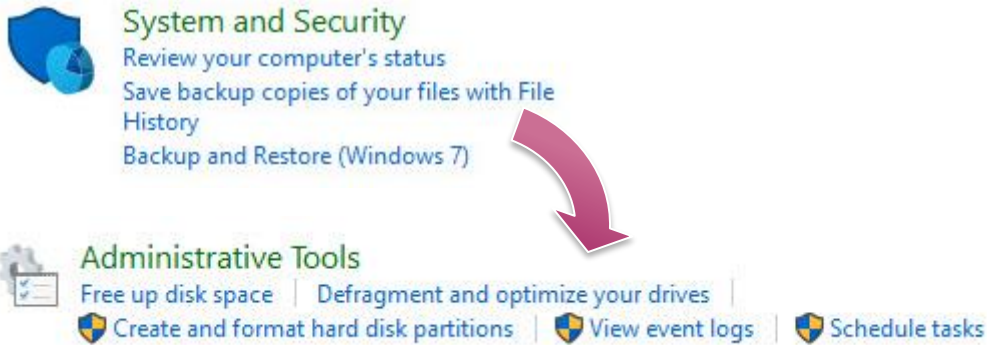

3. Click the Internet Information Services (IIS) Manager

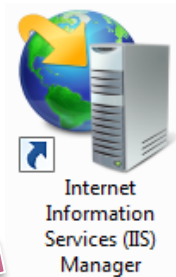

4. In the left pane, expand the local machine, and right-click Sites, and then click the Add FTP site ...

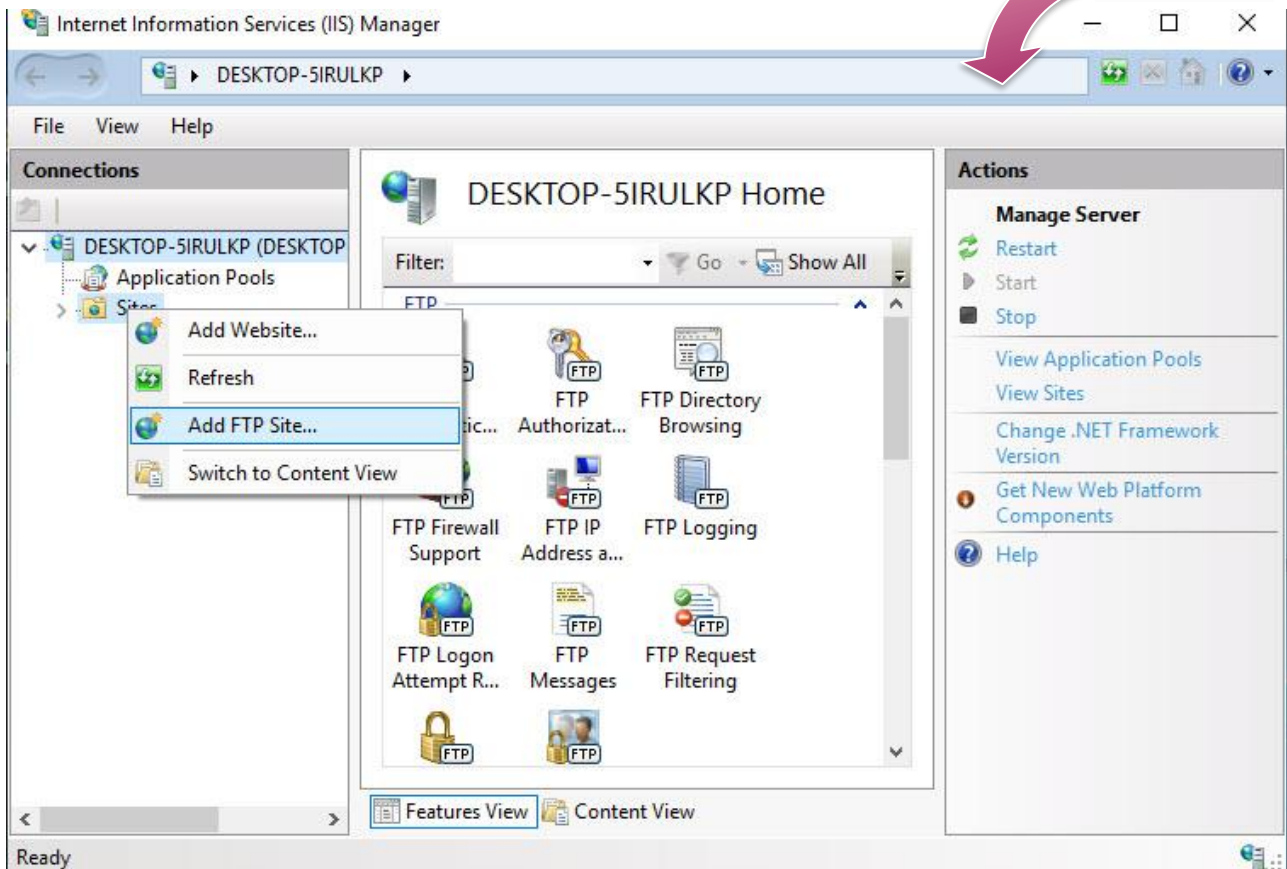

5. Type the name, and then select the Physical path (The default path is c:\inetpub\ftproot)

The screenshot shows the 'Add FTP Site' dialog box with the 'Site Information' tab selected. The 'FTP site name' field contains 'XP-9000-IoT FTP'. The 'Content Directory' section has a 'Physical path' field containing 'T:\Ftproot' and a browse button ('...'). At the bottom, there are buttons for 'Previous', 'Next', 'Finish', and 'Cancel'.

6. Click on the drop down arrow and choose the IP address of your XP-9000-IoT, and then click the Next button

The screenshot shows the 'Add FTP Site' dialog box with the 'Binding and SSL Settings' tab selected. Under 'Binding', the 'IP Address' dropdown is set to 'All Unassigned' and the 'Port' is '21'. The 'Enable Virtual Host Names' checkbox is unchecked. The 'Start FTP site automatically' checkbox is checked. Under 'SSL', the 'No SSL' radio button is selected. The 'SSL Certificate' dropdown is set to 'Not Selected'. At the bottom, the 'Next' button is highlighted with a blue border.

7. Click on the drop down arrow and choose the All users, and then select the Read and Write check box, and then click the Finish button

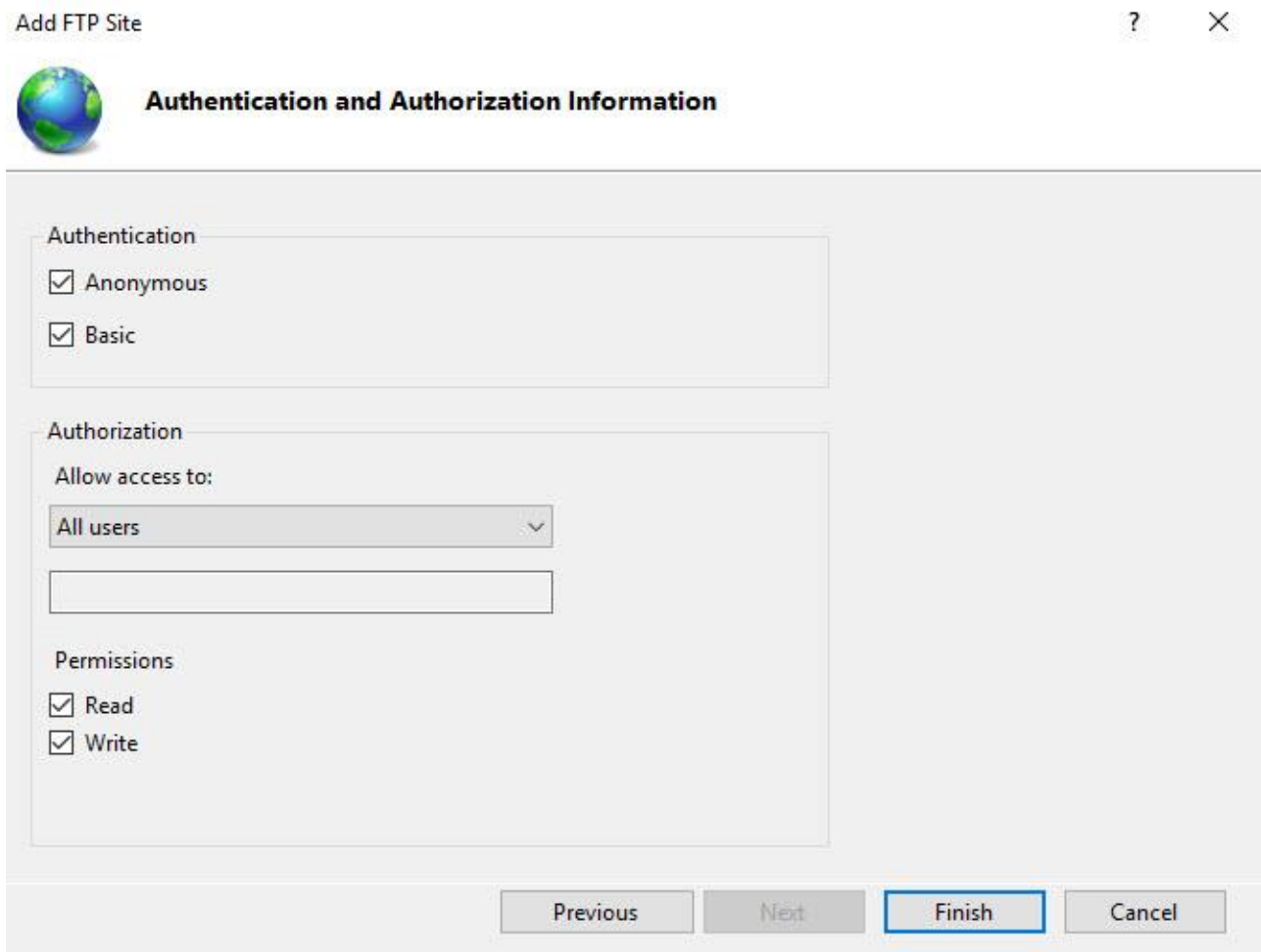

8. Go to the **Control Panel**, click **System and Security**, and then click the **Allow an app through Windows Firewall**

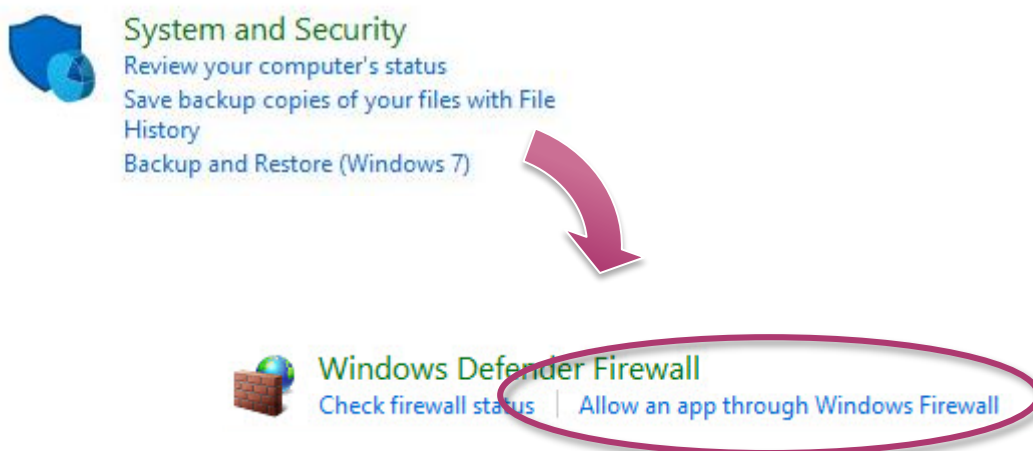

9. Select the **FTP Server** check box, and then click the **OK** button

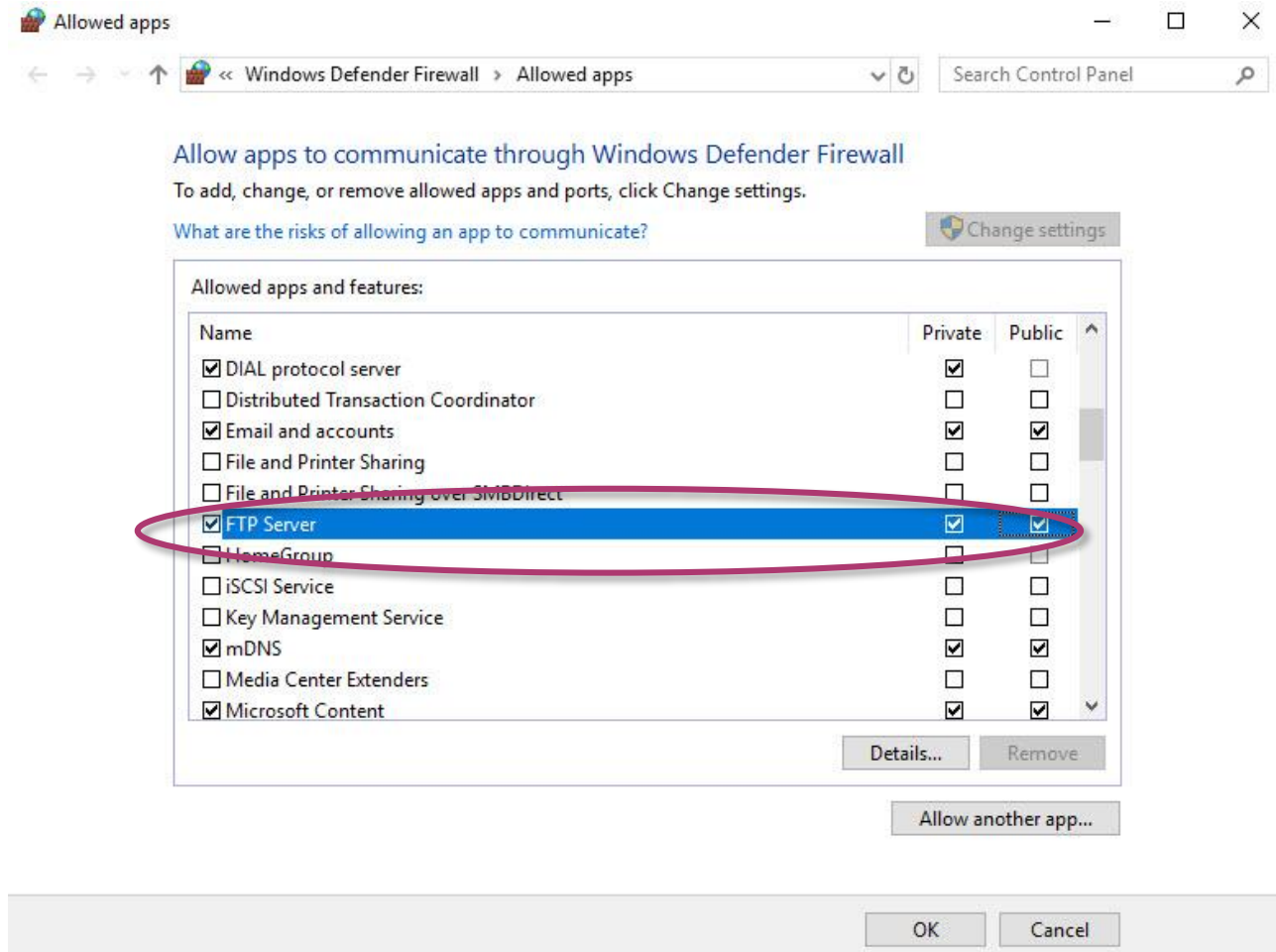

3.4. Configuring the UWF Manager

UWF provides a means for protecting a volume from writes. All writes to an UWF-protected volume are redirected to an overlay. These writes are stored in the overlay and made available as part of the volume. In this way, it feels like that the volume is writeable. The overlay may exist either on disk or in RAM. If desired, the data stored in the overlay may be committed to the protected volume. The following figure is an overview of UWF.

For more detailed information about Unified Write Filter (UWF), please refer to <https://docs.microsoft.com/en-us/windows-hardware/customize/enterprise/unified-write-filter>

On XP-9000-IoT, only the C drive that OS resides can be protected.

In cases of maintenance, the disk must be updated to your desired changes.

There is one way to use contains three steps: (1) disabling UWF, (2) updating, and (3) re-enabling UWF.

To disable the UWF

1. Click the PAC Utility shortcut on the desktop



2. Click the UWF Operation tab, select the Disable check box, and then click Apply button

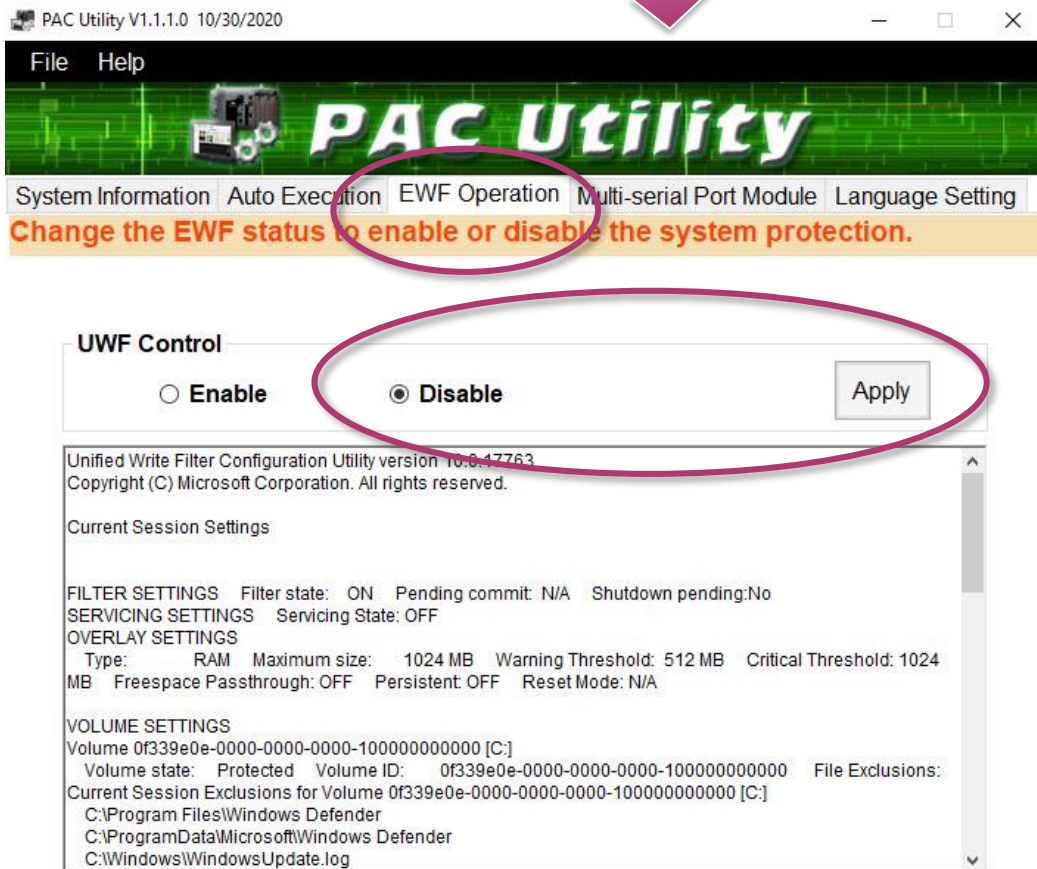

Tips & Warnings



If UWF is disabled and XP-9000-IoT/AXP-9000-IoT suffers sudden power off, the operating system of XP-9000-IoT/AXP-9000-IoT may be damaged or incomplete.







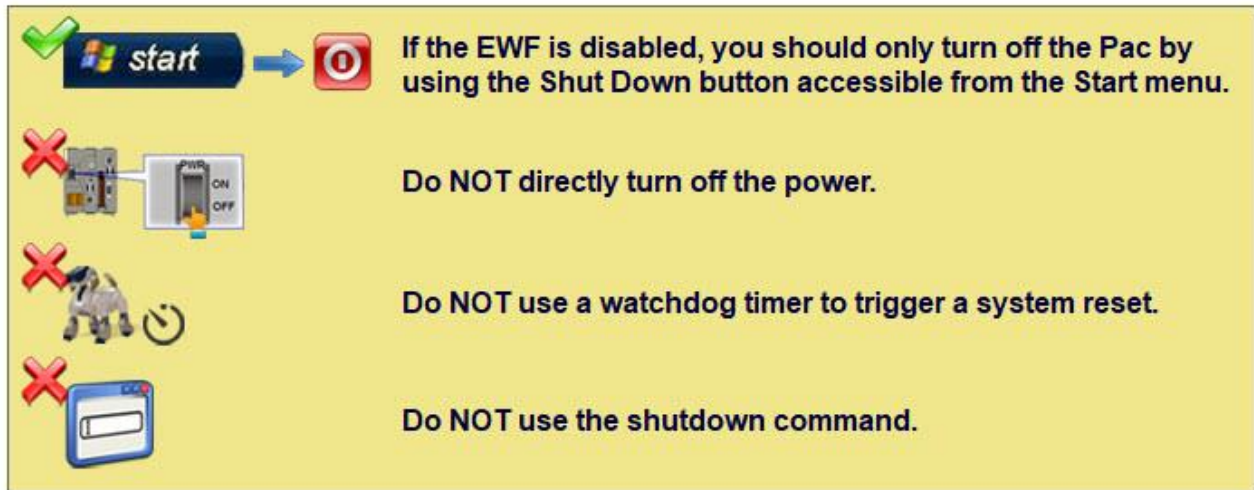

3. In the pop-up dialog box, click Yes button

Disable EWF - Warning

 If the EWF is disabled, the OS will not be properly protected. In this situation, the OS should be shut down only by clicking the Start button and then clicking the Shut Down button in order to prevent the OS from being damaged.





The dialog box contains the following instructions:

-   →  If the EWF is disabled, you should only turn off the Pac by using the Shut Down button accessible from the Start menu.
-   Do NOT directly turn off the power.
-   Do NOT use a watchdog timer to trigger a system reset.
-   Do NOT use the shutdown command.

Are you sure you want to disable the EWF?

 Yes

 No

4. Click the Start button  , click the power button  , and then click Restart for changes to take effect.

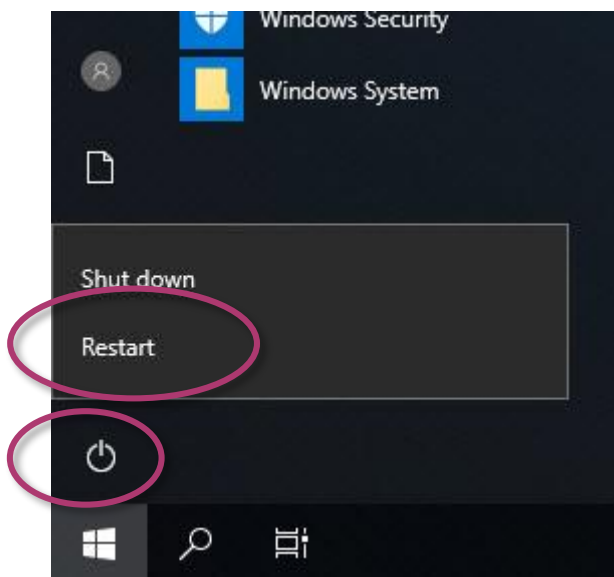

To enable the UWF

1. Click the PAC Utility shortcut on the desktop
2. Click the UWF Operation tab, select the Enable check box, and then click Apply button

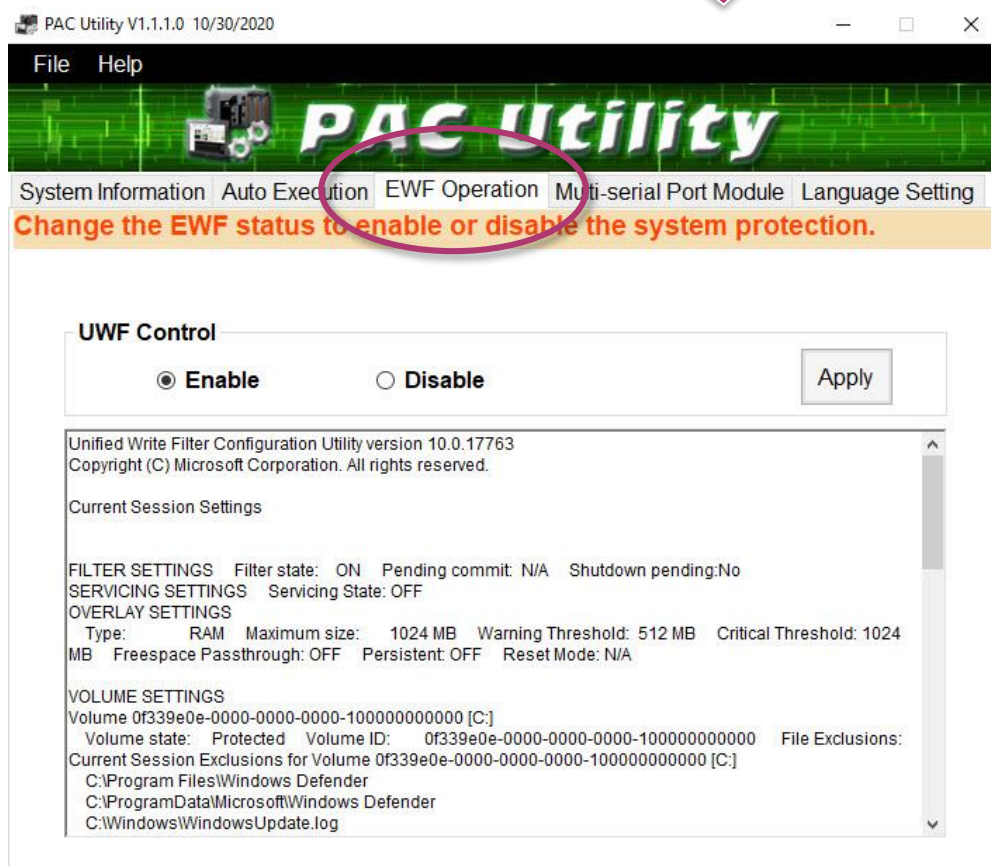



Tips & Warnings

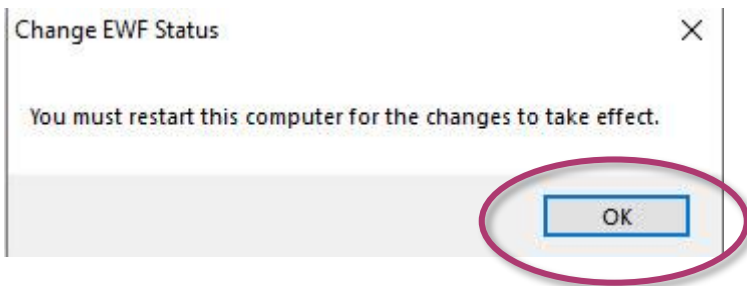

UWF only takes effect on hard drive C (where the operating system resides), it is recommended to download your programs to Compact Flash or USB -HDD. It'll prevent operating system from damages of illegal writing or sudden power off.

3. In the pop-up dialog box, click OK button



4. Click the Start button  , click the power button  , and then click Restart for changes to take effect.

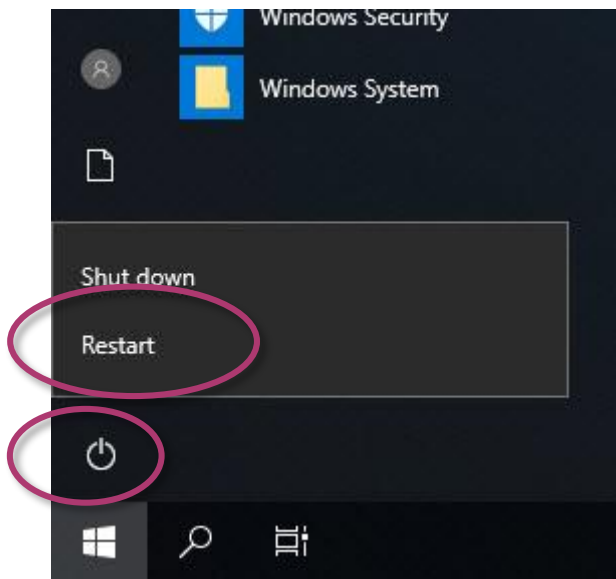

How to use the UWF console application command-line tool

To control the status of UWF, use the UWF Manager Command “UWFMGR”.

Windows 10 IoT includes the Unified Write Filter (UWF) console application command-line tool, Uwfmggr.exe.

- Enable the UWF:
uwfmgr filter enable (it is effective after rebooting.)
- Disable UWF:
uwfmgr filter disable

For more information about using UWF Manager Commands, please refer to **Manager Commands** <https://docs.microsoft.com/en-us/windows-hardware/customize/enterprise/uwfmgrexe>

Tips & Warnings



Only the disk drive (usually, c:\) that OS resides can use the feature of UWF

4. Tools and Tasks

This chapter provides a brief introduction of the XP-9000-IoT service tools and its benefits.

There are several tools and utilities built-in and designed for use with XP-9000-IoT. Some of these are pre-installed on XP-9000-IoT and can work directly on XP-9000-IoT, and some of these are supporting tools and can help you to manage the XP-9000-IoT remotely on a PC.

Tools for working with PC can be found separately by downloading the latest version from ICP DAS web site.

<https://www.icpdas.com/en/download/index.php?model=XP-9181-IoT>

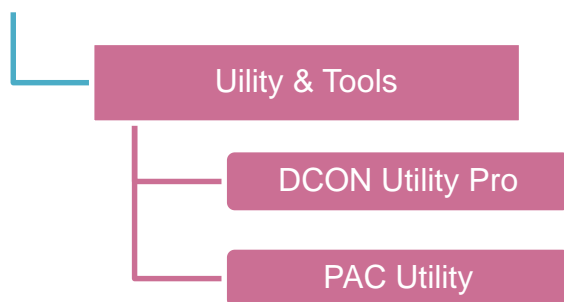

4.1. PAC Utility

PAC Utility is a collection of software applications that enable management and configuration of XP-9000-IoT system and features.

4.1.1. System Information

The System Information tab provides functions to monitor necessary device information of XP-9000-IoT. The system information is the most important note of version control for upgrading system.

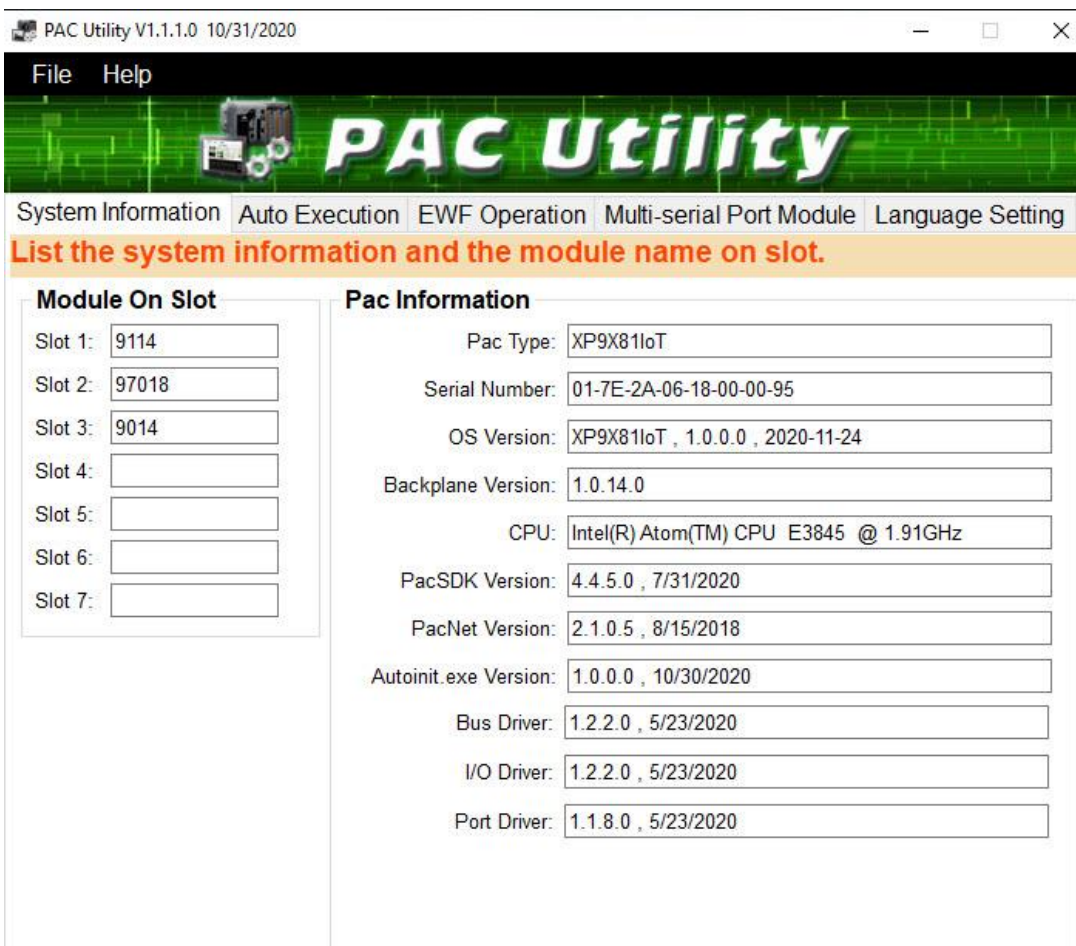

The screenshot displays the PAC Utility V1.1.1.0 application window. The title bar shows the version and date: "PAC Utility V1.1.1.0 10/31/2020". The menu bar includes "File" and "Help". The main interface features a green-themed header with the "PAC Utility" logo and a navigation bar with tabs: "System Information", "Auto Execution", "EWF Operation", "Multi-serial Port Module", and "Language Setting". Below the navigation bar, a red banner reads "List the system information and the module name on slot." The "System Information" tab is active, showing two main sections: "Module On Slot" and "Pac Information".

Module On Slot	
Slot 1:	9114
Slot 2:	97018
Slot 3:	9014
Slot 4:	
Slot 5:	
Slot 6:	
Slot 7:	

Pac Information	
Pac Type:	XP9X81IoT
Serial Number:	01-7E-2A-06-18-00-00-95
OS Version:	XP9X81IoT , 1.0.0.0 , 2020-11-24
Backplane Version:	1.0.14.0
CPU:	Intel(R) Atom(TM) CPU E3845 @ 1.91GHz
PacSDK Version:	4.4.5.0 , 7/31/2020
PacNet Version:	2.1.0.5 , 8/15/2018
Autoinit.exe Version:	1.0.0.0 , 10/30/2020
Bus Driver:	1.2.2.0 , 5/23/2020
I/O Driver:	1.2.2.0 , 5/23/2020
Port Driver:	1.1.8.0 , 5/23/2020

4.1.2. Auto Execution

The Auto Execution tab provides functions to configure programs running at XP-9000-IoT startup, it allows users to configure ten execute files at most.

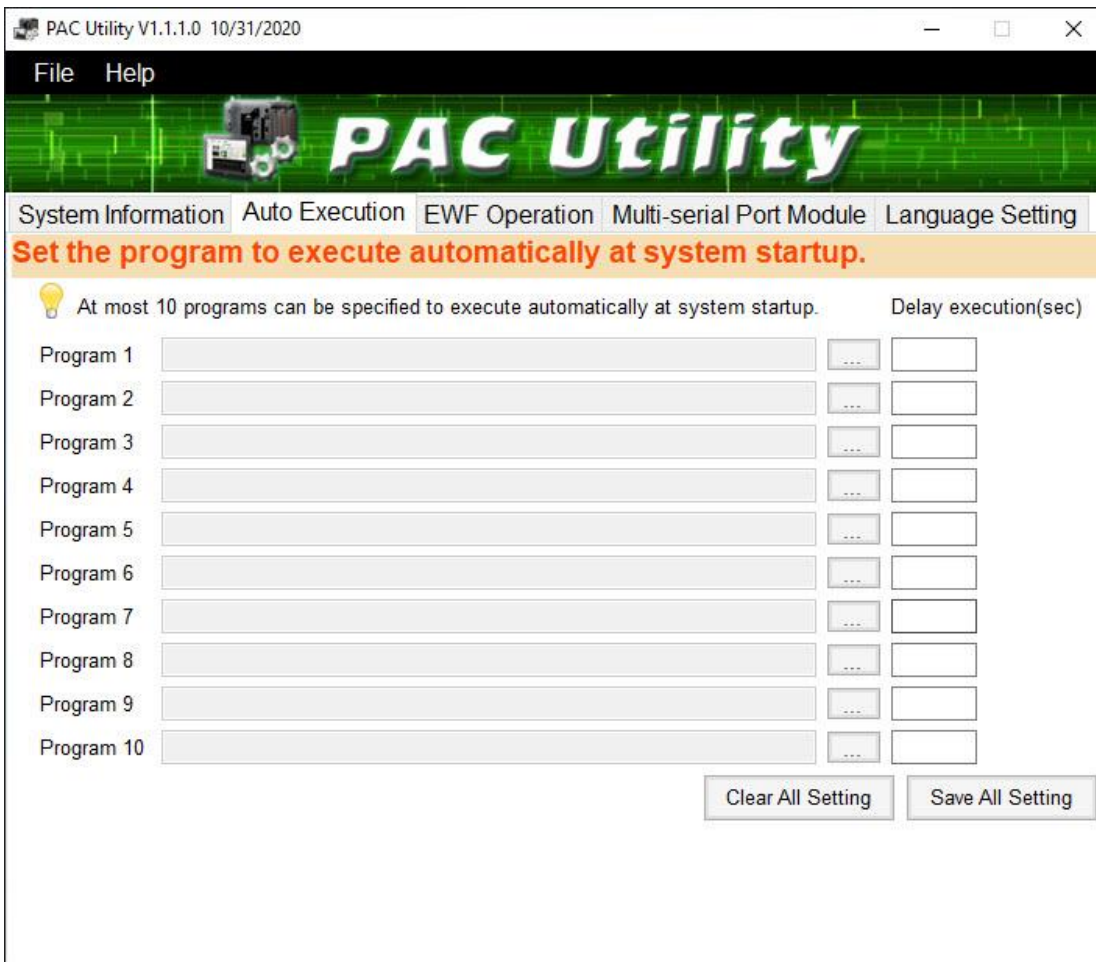

Tips & Warnings



The allowed file types are .exe and .bat, and they are executed in order of program 1, program 2, etc.

The tab use to	How to use
Configure programs running at startup	Click on the Browse button and select the execute file which you want, and then click the Save All Setting button.

4.1.3. UWF Operation

The UWF Operation tab provides functions to configure UWF.

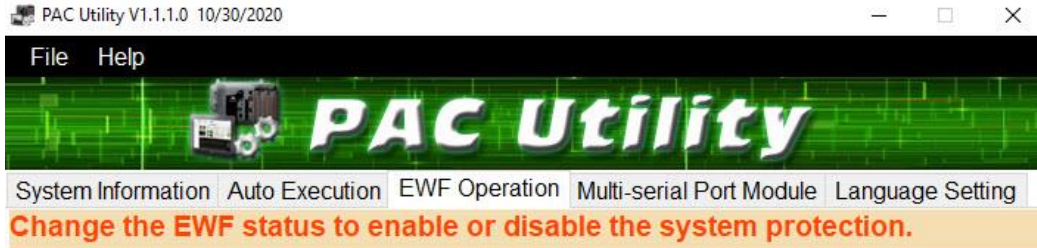

The tab use to	How to use
Enable/disable the UWF function	<p>Enable the UWF function: Select the Enable option, and then click the Apply button.</p> <p>Disable the UWF function: Select the Disable option, and then click the Apply button.</p>

4.1.4. Multi-serial Port Module



The Multi-serial port provides functions for installation of the RS-232/RS-422/RS-485 communication module driver.

The table below shows the expansion RS-232/RS-422/RS-485 communication modules that are compatible with the XP-9000-IoT.

Item	RS-232	RS-422/RS-485	Isolation	Connector
I-9114	4	4	2500 Vrms	DB-37 (Female) x 1
I-9144	-	4	2500 Vrms	Terminator block x 1

The XP-9000-IoT can be expanded to support up to 16 I/O modules.

For more detailed information about these support modules, please refer to

https://www.icpdas.com/en/product/guide+Remote_I_O_Module_and_Unit+PAC_%EF%BC%86amp;+Local_I_O_Modules+I-9K_I-97K_Series



4.2. DCON Utility Pro

The DCON Utility Pro is a toolkit that help user to search the network, easily to configure and test the I/O modules via the serial port (RS-232/485) or Ethernet port (using virtual com port).

For more information on how to use DCON Utility Pro to configure I/O modules, please refer to section 2.6. Using DCON Utility Pro to Configure I/O Modules.

5. Your First XP-9000-IoT Program

This chapter provides a guided tour that describes the steps needed to set-up a development environment, download, install, configure for user programming with the XP-9000-IoT.

Before writing your first program, ensure that you have the necessary development tool and the corresponding XP-9000-IoT SDKs are installed on your system.

Development Tools

XP-9000-IoT is a IoT based unit. IoT is a mature embedded operating system which supports rapid development. Three standard development tools are list as follows which are highly integrated, with comprehensive support for developing applications of IoT based XP-9000-IoT.

- Visual Basic.net
- Visual C#
- Visual C++

XP-9000-IoT SDKs

The PAC SDK is a Software Development Kit (SDK) that contains C header files, C libraries and documents.

The XP-9000-IoT SDK are classified by development tools that can be obtained by downloading the latest version from ICP DAS web site.

<https://www.icpdas.com/en/download/index.php?model=XP-9181-IoT>

5.1. Your First XP-9000-IoT Program in VB.NET

The best way to learn programming with XP-9000-IoT is to actually create a XP-9000-IoT program.

The example below will guide you through creating this simple program in VB.net and running them on XP-9000-IoT.

To create a demo program with VB.NET that includes the following main steps:

1. Create a new project
2. Specify the path of the PAC reference
3. Add the control to the form
4. Add the event handling for the control
5. Upload the application to XP-9000-IoTT
6. Execute the application on XP-9000-IoT

All main steps will be described in the following subsection.

5.1.1. Create a New Project

The Visual VB.net project template is a composite control that you use in this example creates a new project with this user control.

1. Run the Visual Studio 2008

Visual Studio 2008



2. On the File menu, point to New, and then click Project

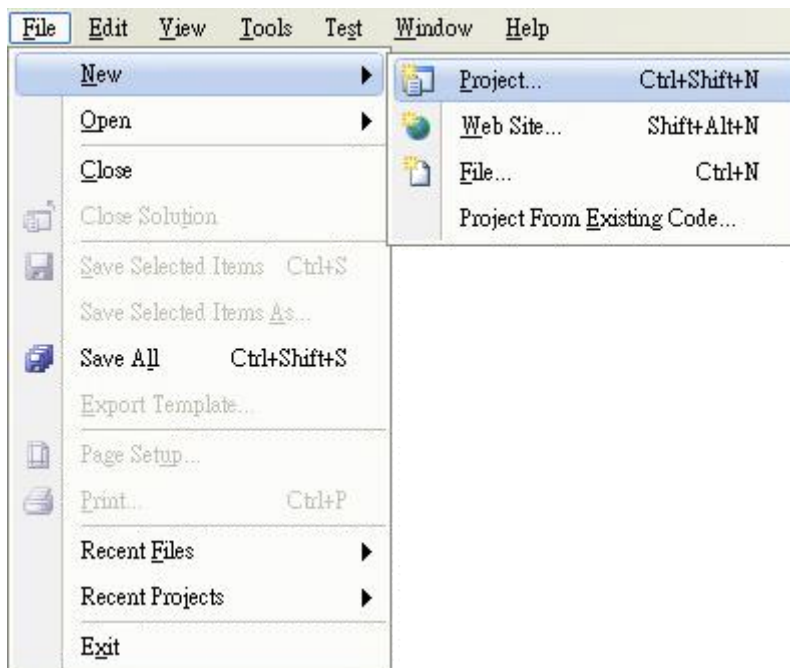

3. In the Project types pane, expand Visual Basic, and then click Windows

4. In the Templates pane, click Windows Forms Application

5. Type a name in the Name field, and then click OK button

Here we will enter the name “SDKInfo” and a different location for the project if you wish

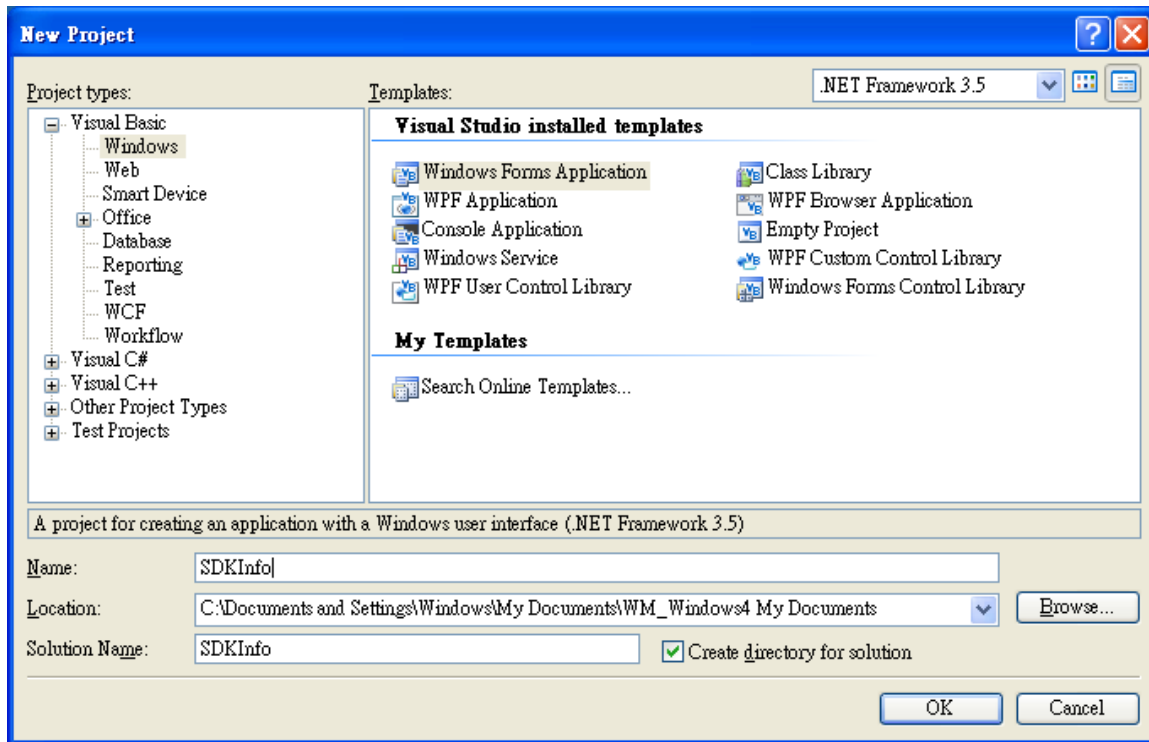

5.1.2. Specify the Path of PAC Reference

The PAC SDK provides a complete solution to integrate with XP-9000-IoT and it's compatible with Visual C#, Visual Basic .net and C++. In order to use a component in your application, you must first add a reference to it.

1. Get the PACNET.dll and copy it to the project folder

The PACNET.dll can be obtained separately by downloading the latest version from ICP DAS web site.

<https://www.icpdas.com/en/download/index.php?model=XP-9181-IoT>



2. In the Solution Explorer, right-click the References node, and then click Add Reference...

3. Click the Browse tab, and then select the PACNET.dll

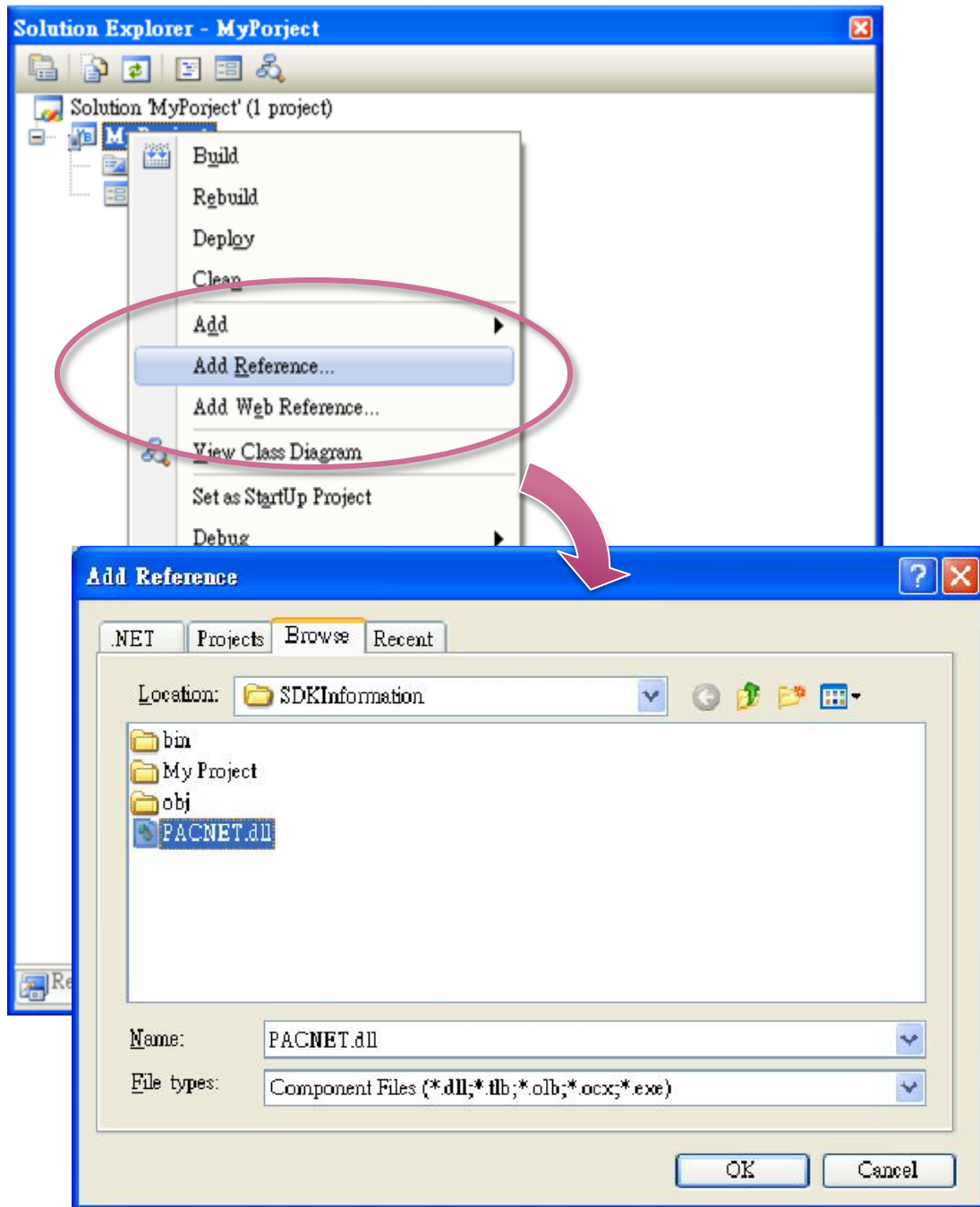

5.1.3. Add the Control to the Form

You can drag various controls from the Toolbox onto the form. These controls are not really "live"; they are just images that are convenient to move around on the form into a precise location.

After you add a control to your form, you can use the Properties window to set its properties, such as background color and default text. The values that you specify in the Properties window are the initial values that will be assigned to that property when the control is created at run time.

1. From the Toolbox, drag a Button control onto the form

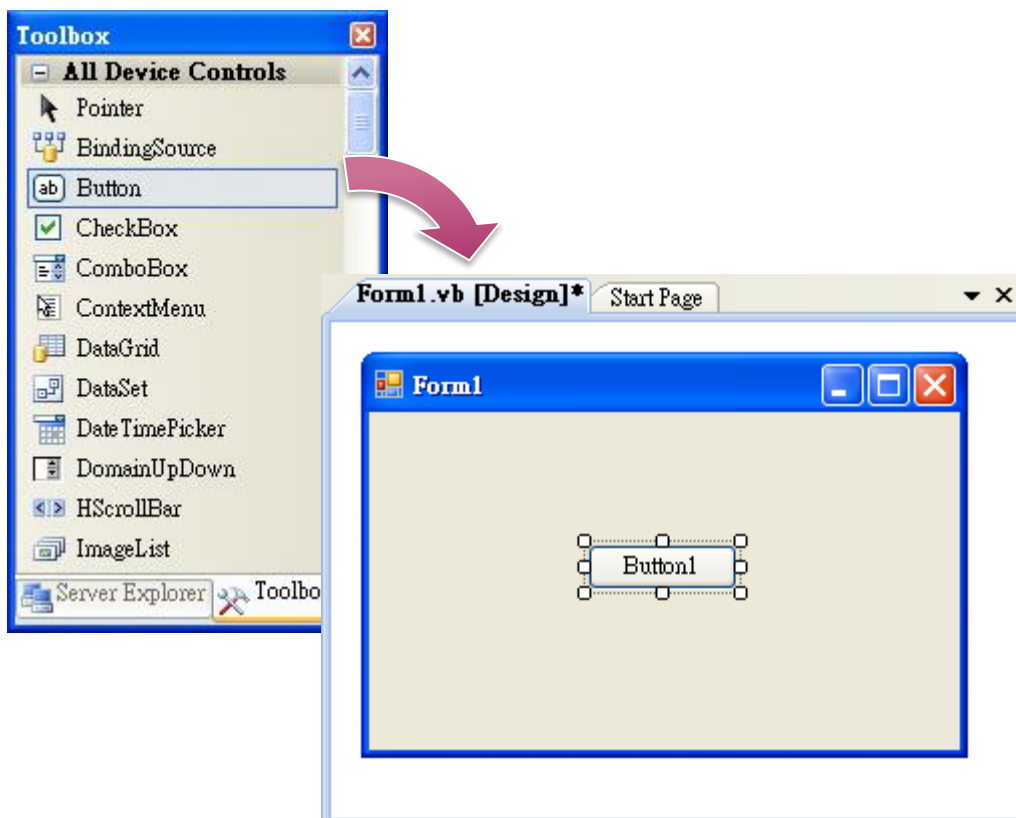

2. Right-click the Button control, and then click Properties

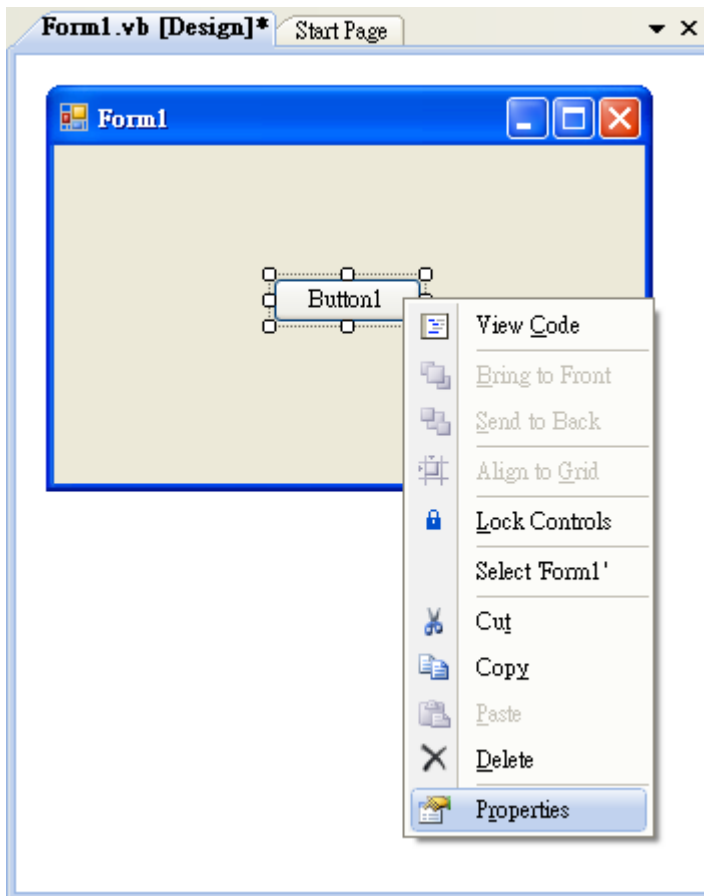

3. In the Properties window, type Check the SDK version in the Text item, and press ENTER

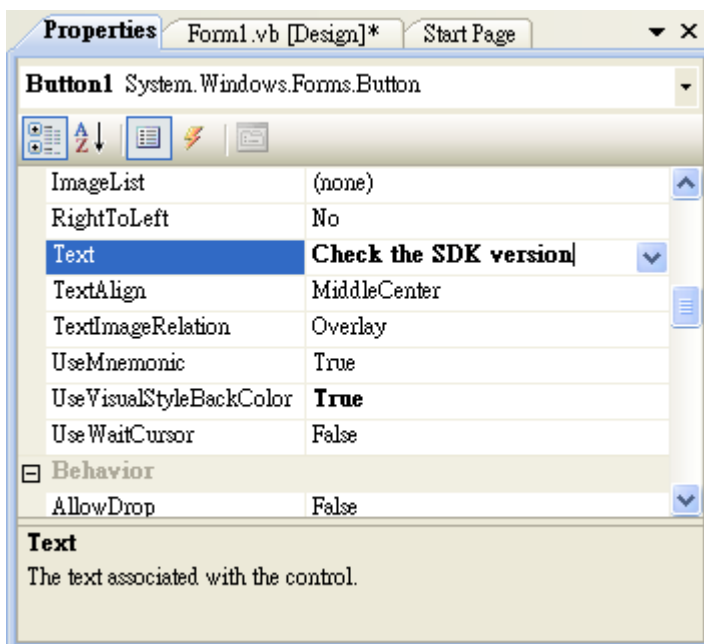

5.1.4. Add the Event Handling for the Control

You have finished the design stage of your application and are at the point when you can start adding some code to provide the program's functionality.

1. Double-click the button on the form

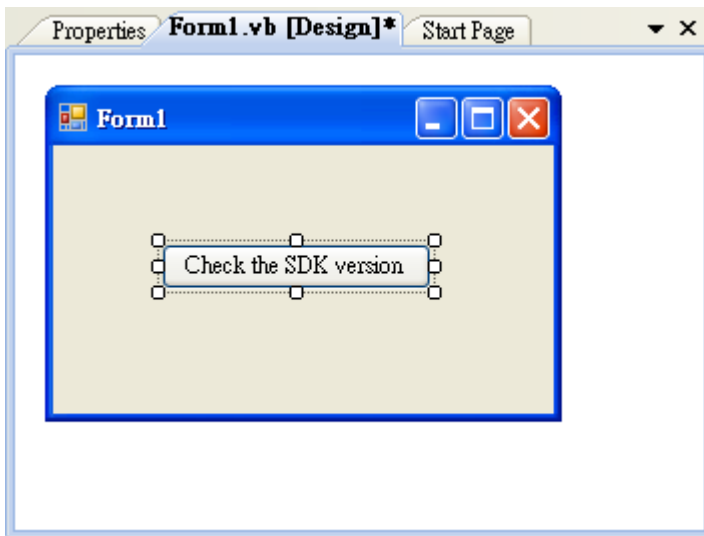

2. Inserting the following code

```
Dim data(30) As Byte
PACNET.Sys.GetSDKVersion(data)
MessageBox.Show(PACNET.MISC.WideString(data))
```

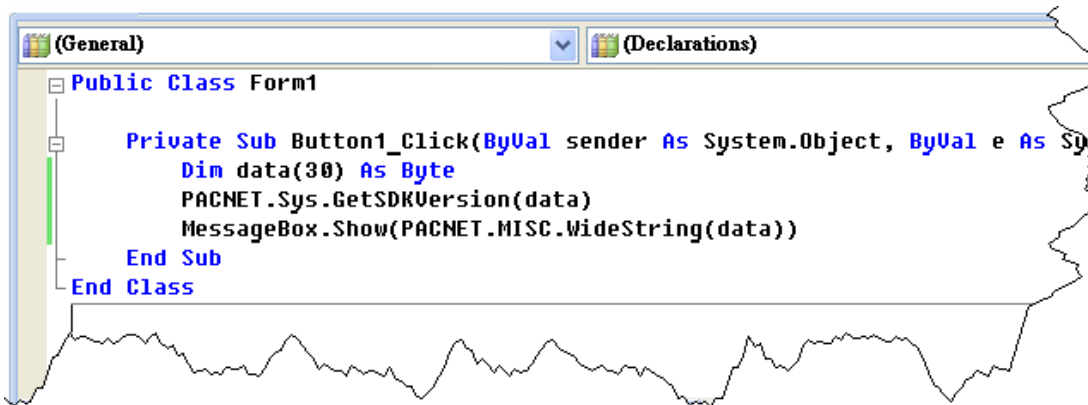

The screenshot shows a Visual Studio code editor window with two tabs: "(General)" and "(Declarations)". The code is written in a class named "Form1". The code is as follows:

```
Public Class Form1
    Private Sub Button1_Click(ByVal sender As System.Object, ByVal e As System.EventArgs) Handles Button1.Click
        Dim data(30) As Byte
        PACNET.Sys.GetSDKVersion(data)
        MessageBox.Show(PACNET.MISC.WideString(data))
    End Sub
End Class
```

Tips & Warnings



The "PACNET" of "using PACNET" is case-sensitive.

5.1.5. Upload the Application to XP-9000-IoT

XP-9000-IoT supports FTP server service. You can upload files to XP-9000-IoT or download files from a public FTP server.

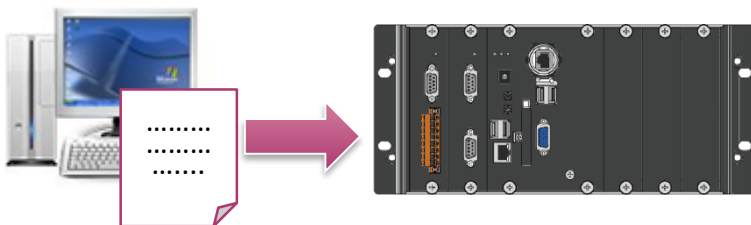

1. On the Build menu, click Build Solution

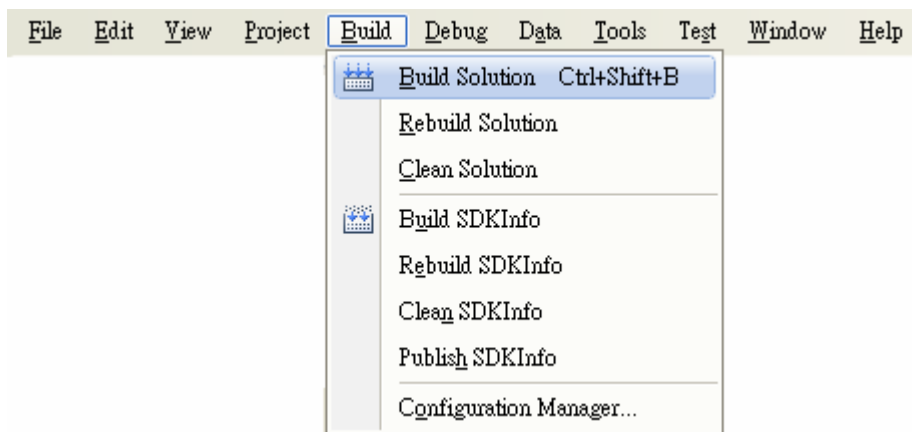

2. Open the browser and type the IP address of XP-9000-IoT/AXP-9000-IoT

3. Upload the SDKInfo.exe application and the corresponding PACNET.dll files to XP-9000-IoT

Tips & Warnings



For applications programming in C# and VB.net with .net compact framework, when executing these application on XP-9000-IoT, the corresponding PACNET.dll must be in the same directory as the .exe file.

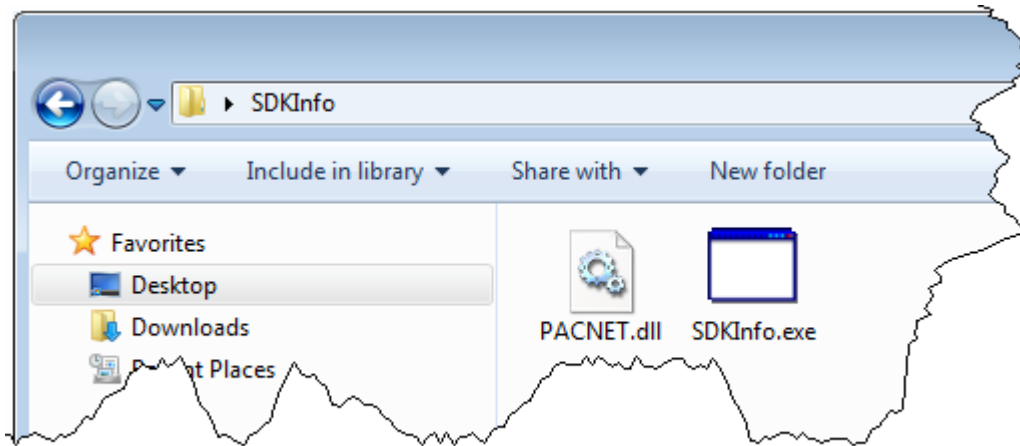

5.1.6. Execute the Application on XP-9000-IoT

After uploading the application to XP-9000-IoT, you can just double-click it to execute it.

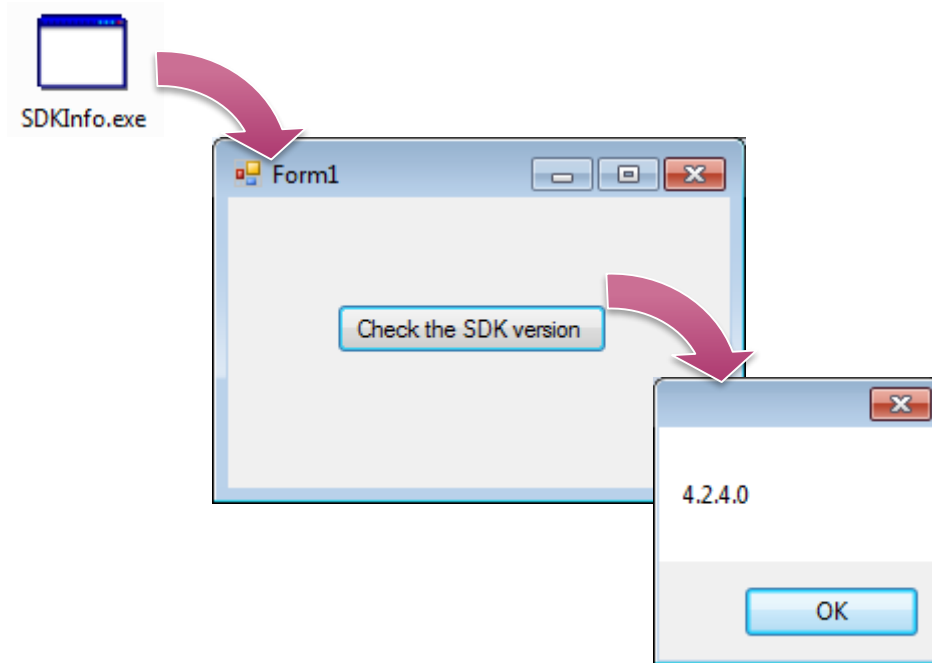

5.2. Your First XP-9000-IoT Program in C#

The best way to learn programming with XP-9000-IoT is to actually create a XP-9000-IoT program.

The example below will guide you through creating this simple program in C# and running them on XP-9000-IoT.

To create a demo program with C# that includes the following main steps:

1. Create a new project
2. Specify the path of the PAC reference
3. Add the control to the form
4. Add the event handling for the control
5. Upload the application to XP-9000-IoT
6. Execute the application on XP-9000-IoT

All main steps will be described in the following subsection.

5.2.1. Create a New Project

The C# project template is a composite control that you use in this example creates a new project with this user control.

1. Run the Visual Studio 2008

Visual Studio 2008



2. On the File menu, point to New, and then click Project

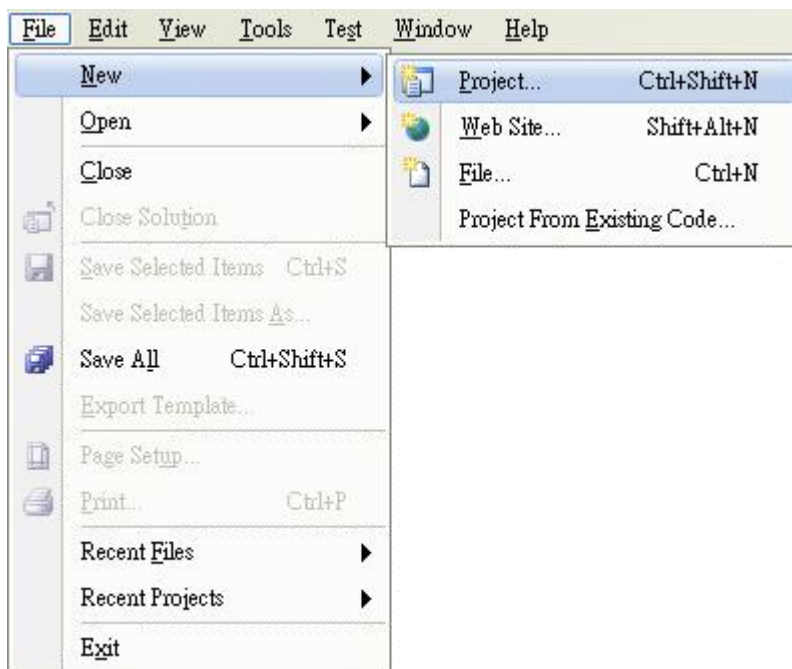

3. In the Project types pane, expand Visual C#, and then click Windows

4. In the Templates pane, click Windows Forms Application

5. Type a name in the Name field, and then click OK button

Here we will enter the name “SDKInfo” and a different location for the project if you wish

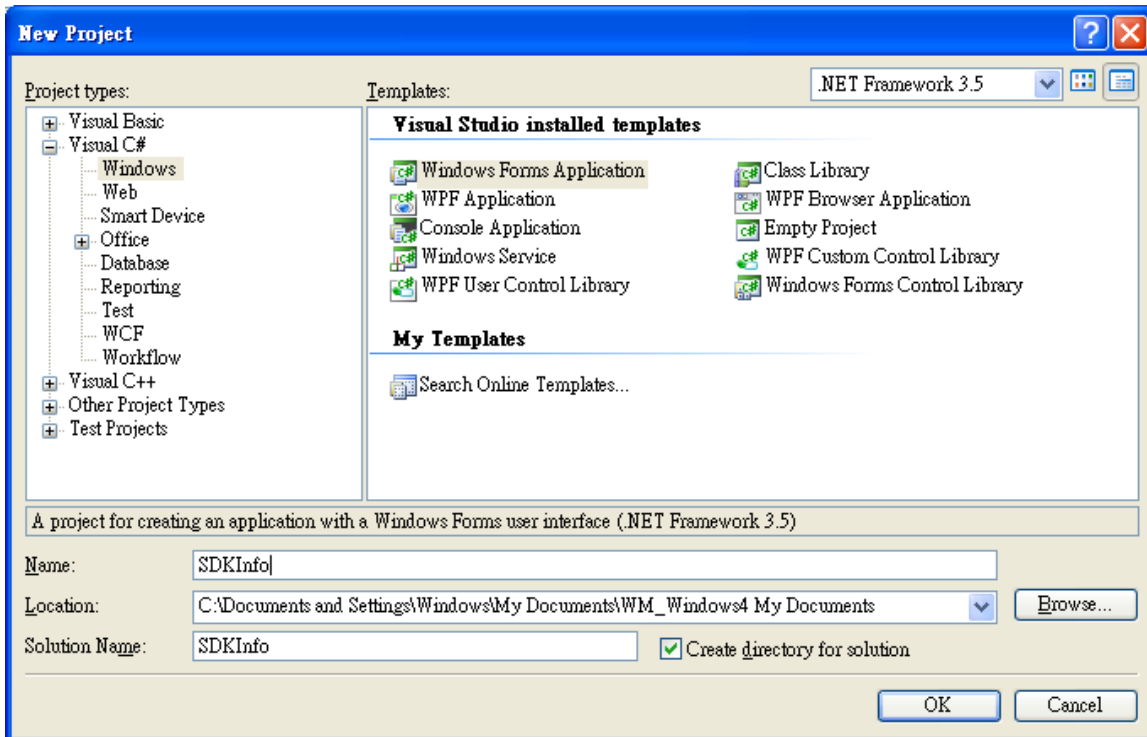

5.2.2. Specify the Path of PAC Reference

The PAC SDK provides a complete solution to integrate with XP-9000-IoT and it's compatible with Visual C#, Visual Basic .net and C++. In order to use a component in your application, you must first add a reference to it.

1. Get the PACNET.dll and copy it to the project folder

The PACNET.dll can be obtained separately by downloading the latest version from ICP DAS web site.

<https://www.icpdas.com/en/download/index.php?model=XP-9181-IoT>



2. In Solution Explorer, right-click the References node, and then click Add Reference...

3. Select Browse tab and add the PACNET.dll

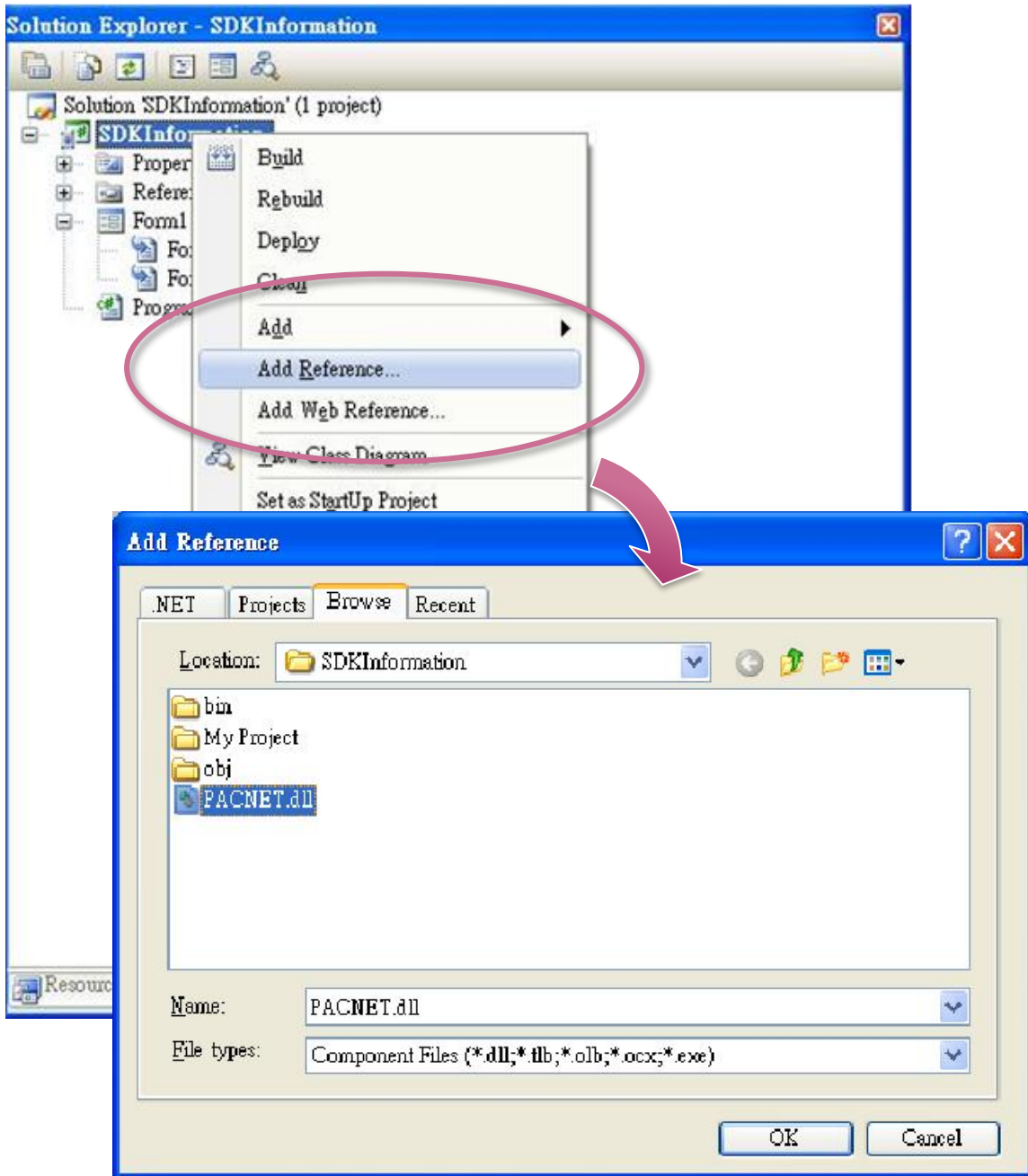

5.2.3. Add the Control to the Form

You can drag various controls from the Toolbox onto the form. These controls are not really "live"; they are just images that are convenient to move around on the form into a precise location.

After you add a control to your form, you can use the Properties window to set its properties, such as background color and default text. The values that you specify in the Properties window are the initial values that will be assigned to that property when the control is created at run time.

1. From the Toolbox, drag a Button control onto the form

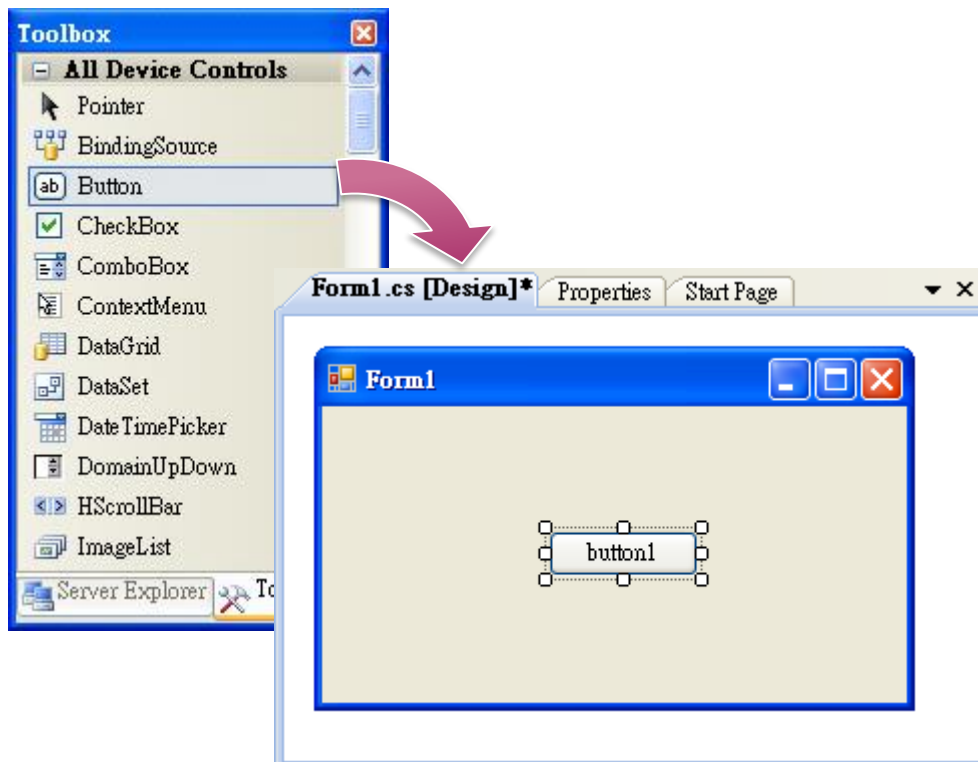

2. Right-click the Button control, and then click Properties

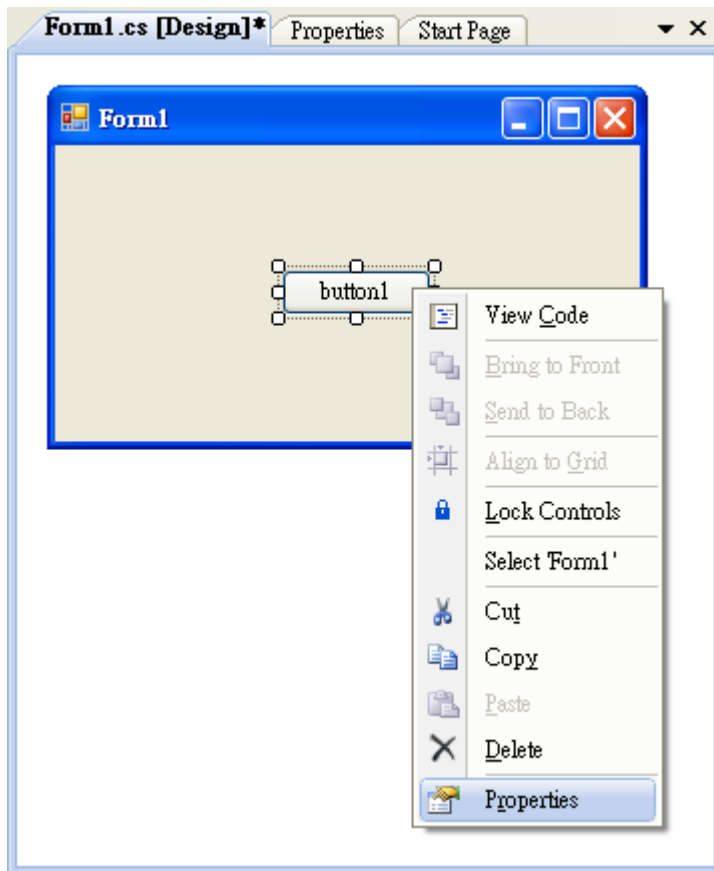

3. In the Properties window, type Check the SDK version in the Text item, and press ENTER

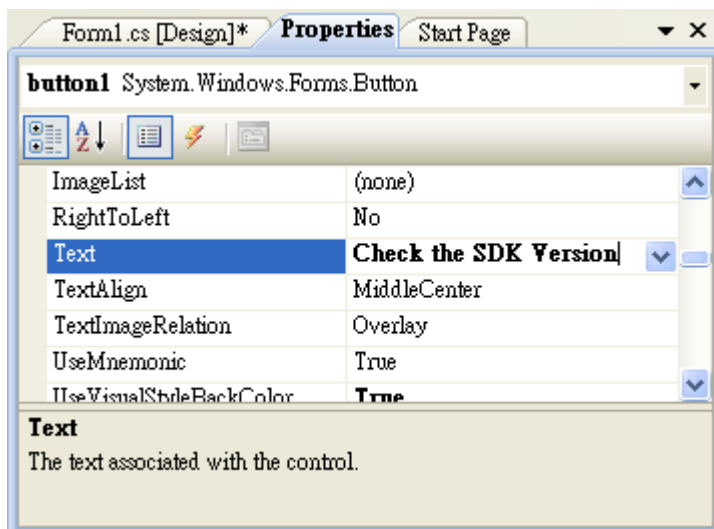

5.2.4. Add the Event Handling for the Control

You have finished the design stage of your application and are at the point when you can start adding some code to provide the program's functionality.

1. Double-click the button on the form

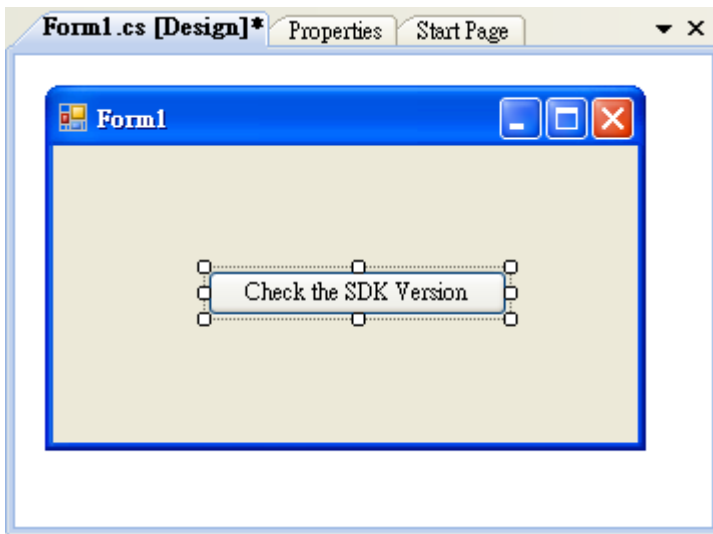

2. Inserting the following code

```
byte []data = new byte[30];  
PACNET.Sys.GetSDKVersion(data);  
MessageBox.Show(PACNET.MISC.WideString(data));
```

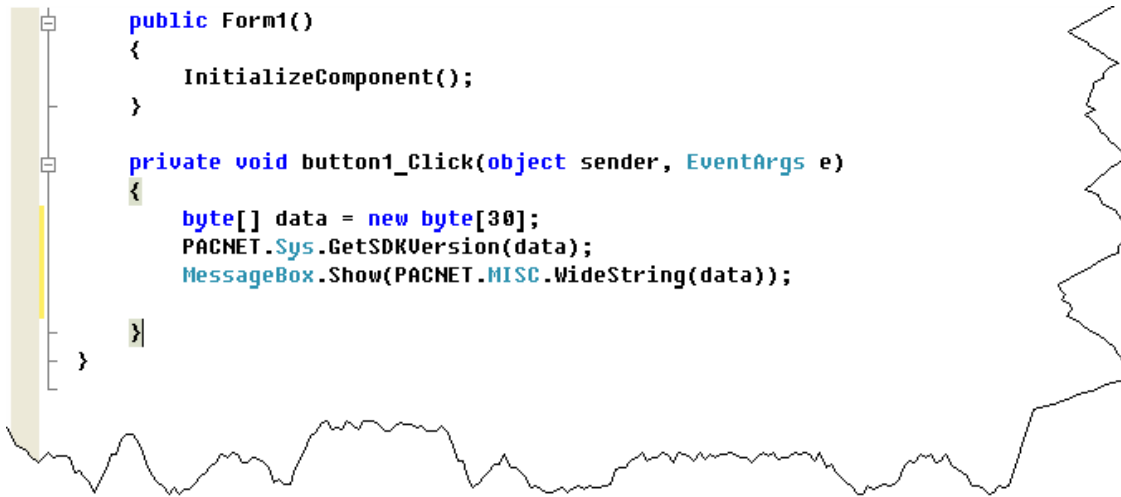

```
public Form1()  
{  
    InitializeComponent();  
}  
  
private void button1_Click(object sender, EventArgs e)  
{  
    byte[] data = new byte[30];  
    PACNET.Sys.GetSDKVersion(data);  
    MessageBox.Show(PACNET.MISC.WideString(data));  
}  
}
```

Tips & Warnings



The “PACNET” of “using PACNET” is case- sensitive.

5.2.5. Upload the Application to XP-9000-IoT

XP-9000-IoT supports FTP server service. You can upload files to XP-9000-IoT or download files from a public FTP server.

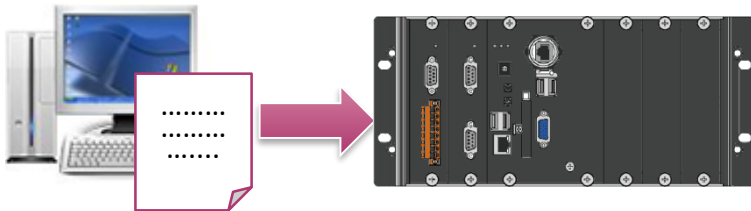

1. On the Build menu, click Build Solution

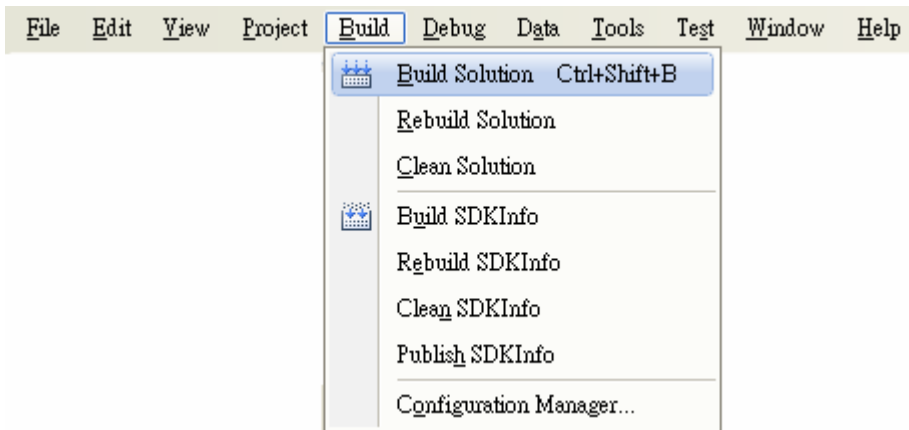

2. Open the browser and type the IP address of XP-9000-IoT

3. Upload the SDKInfo.exe application and the corresponding PACNET.dll files to XP-9000-IoT

Tips & Warnings



For applications programming in C# and VB.net with .net compact framework, when executing these application on XP-9000-IoT, the corresponding PACNET.dll must be in the same directory as the .exe file.

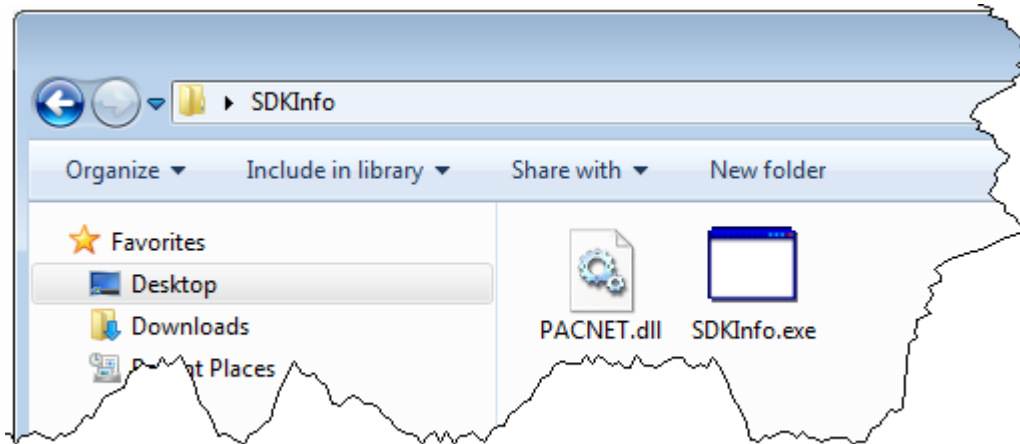

5.2.6. Execute the Application on XP-9000-IoT

After uploading the application to XP-9000-IoT, you can just double-click it to execute it.

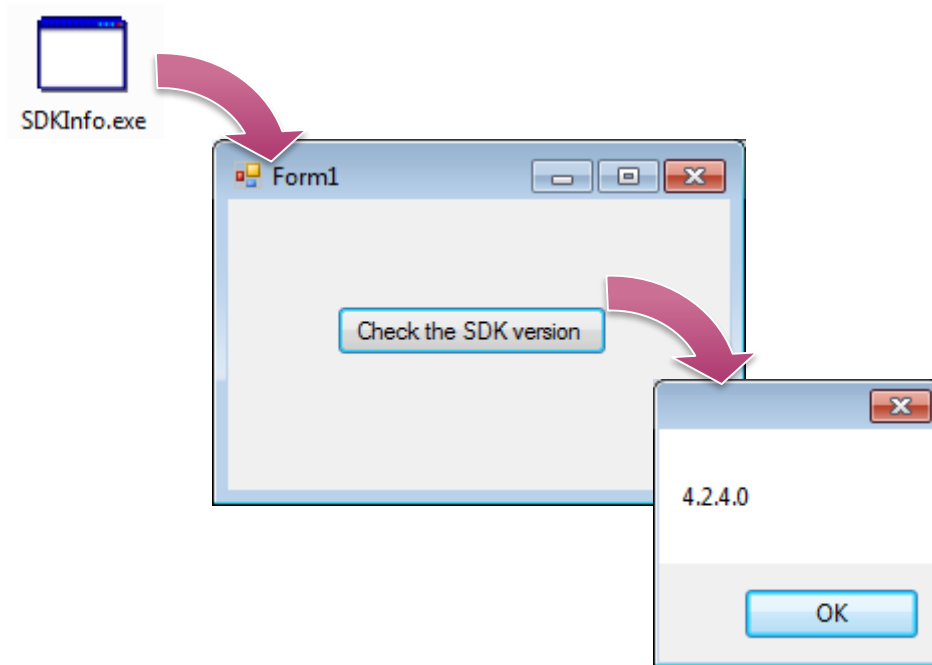

5.3. Your First XP-9000-IoT Program in Visual C++

The best way to learn programming with XP-9000-IoT is to actually create a XP-9000-IoT program.

The example below will guide you through creating this simple program in Visual C++ and running them on XP-9000-IoT.

To create a demo program with Visual C++ that includes the following main steps:

1. Create a new project
2. Specify the path of the XP-9000-IoT reference
3. Add the control to the form
4. Add the event handling for the control
5. Upload the application to XP-9000-IoT
6. Execute the application on XP-9000-IoT

All main steps will be described in the following subsection.

5.3.1. Create a New Project

The Visual C++ project template is a composite control that you use in this example creates a new project with this user control.

1. Run the Visual Studio 2008

Visual Studio 2008



2. On the File menu, point to New, and then click Project

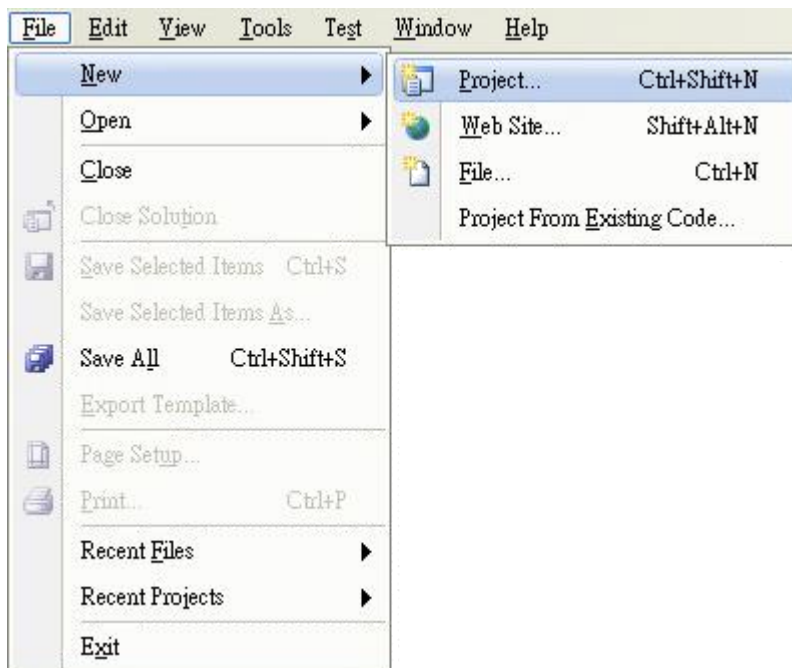

3. In the Project types pane, expand Visual C++, and then click MFC

4. In the Templates pane, click MFC Application

5. Type a name in the Name field, and then click OK

Here we will enter the name “SDKInfo” and a different location for the project if you wish

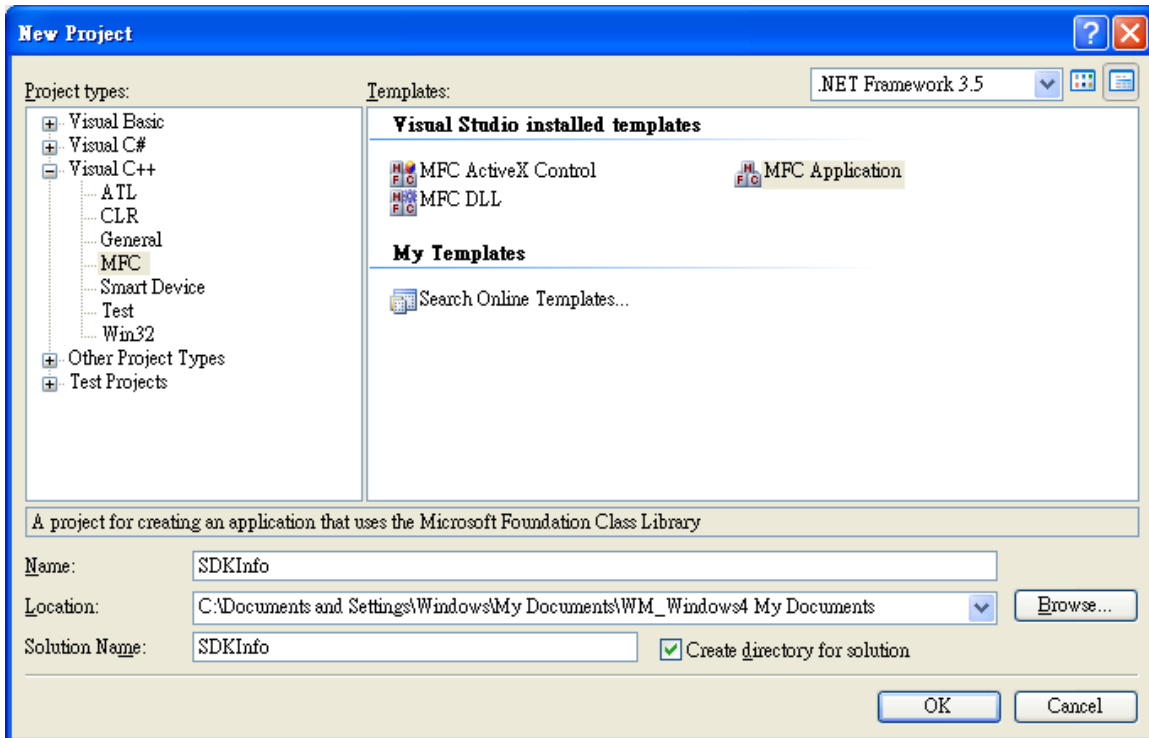

6. On the first page of the wizard, click Next >

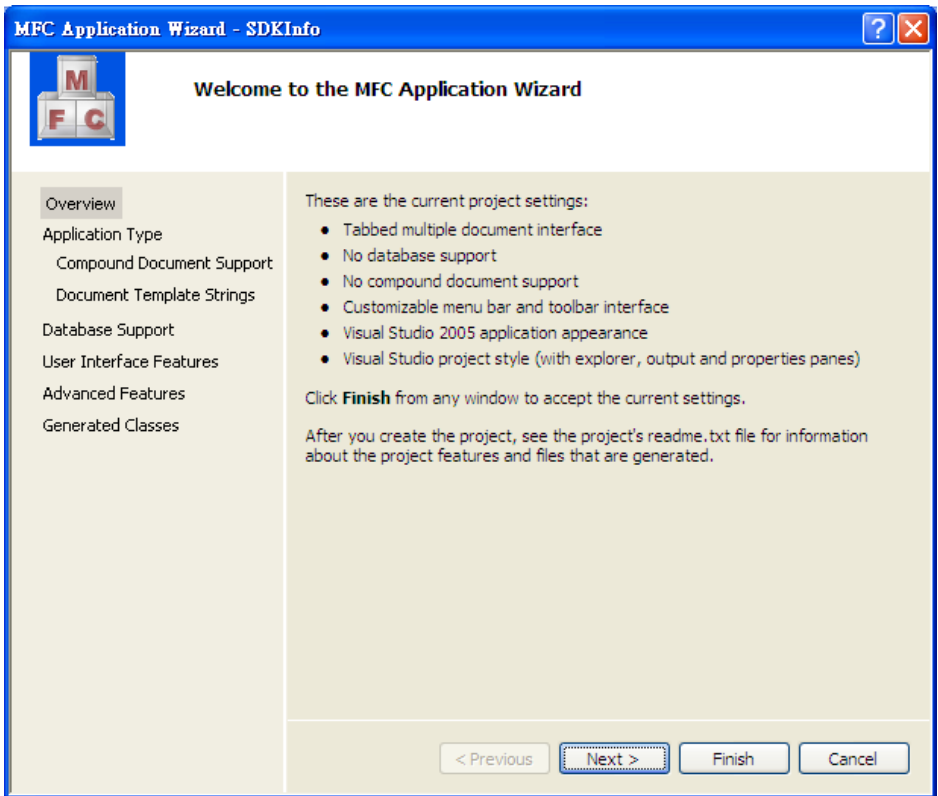

7. On the next page of the wizard, select Dialog based, select Use MFC in a static library, and then click Finish

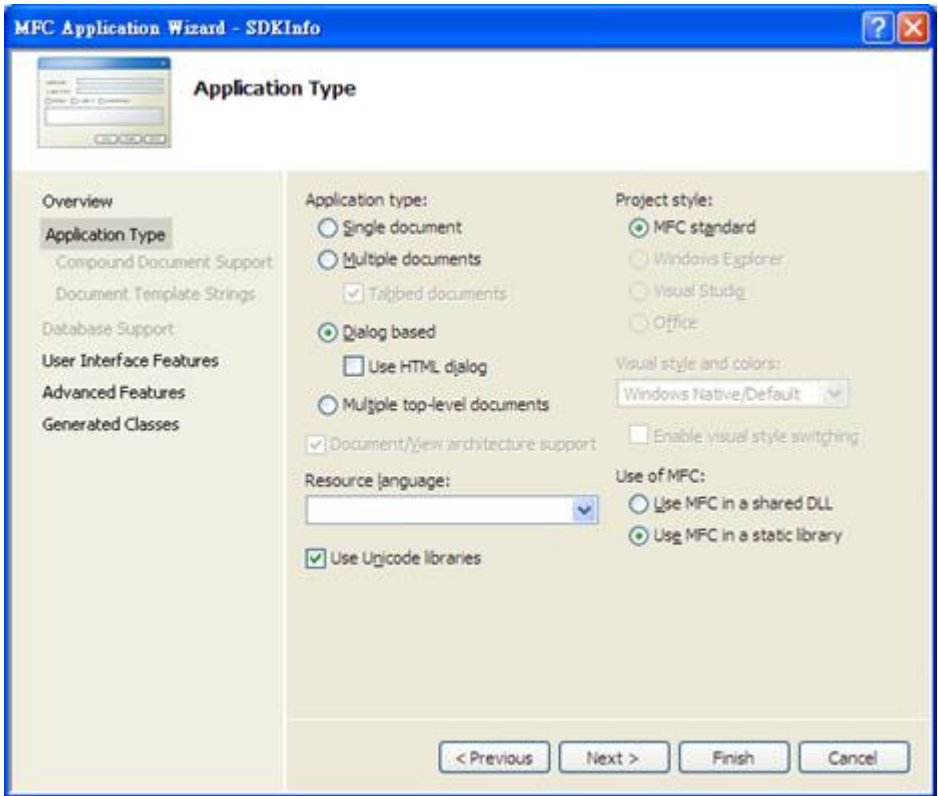

5.3.2. Specify the Path of the PAC Reference

The PAC SDK provides a complete solution to integrate with XP-9000-IoT and it's compatible with Visual C#, Visual Basic .net and C++. In order to use a component in your application, you must first add a reference to it.

1. Get the PACSDK.H and PACSDK.lib, and copy them to the project folder

The PACSDK.H and PACSDK.lib can be obtained separately by downloading the latest version from ICP DAS web site.

<https://www.icpdas.com/en/download/index.php?model=XP-9181-IoT>

2. On the Tools menu, and then click Options

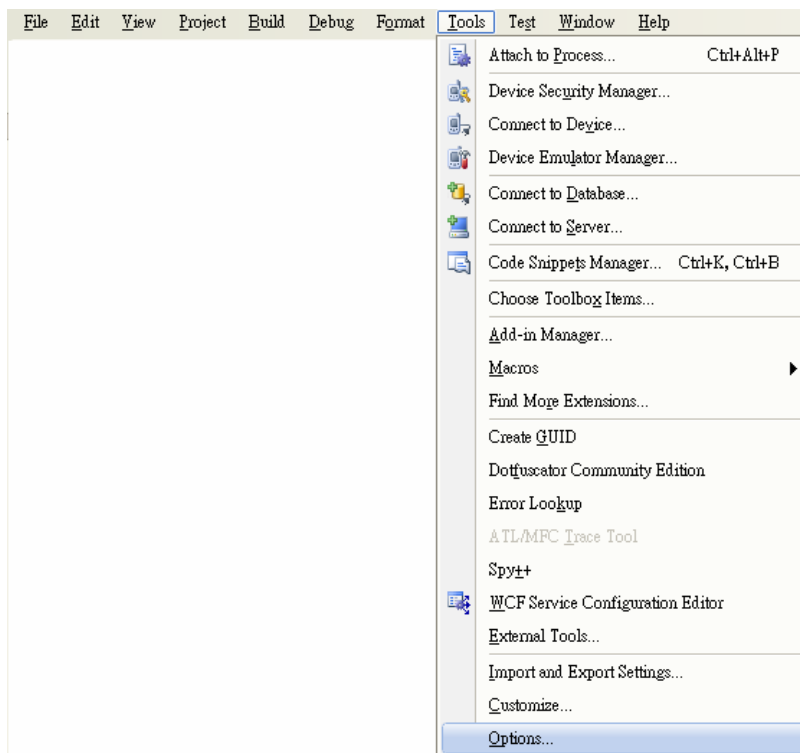

3. In the left pane, expand Projects and Solutions, and then click the VC++ Directories

4. Select Include files in the Show directories for drop down box, and then click the New Line button

5. Add a new line to the list of directories. Browse to the directory that contains the PACSDK.H file.

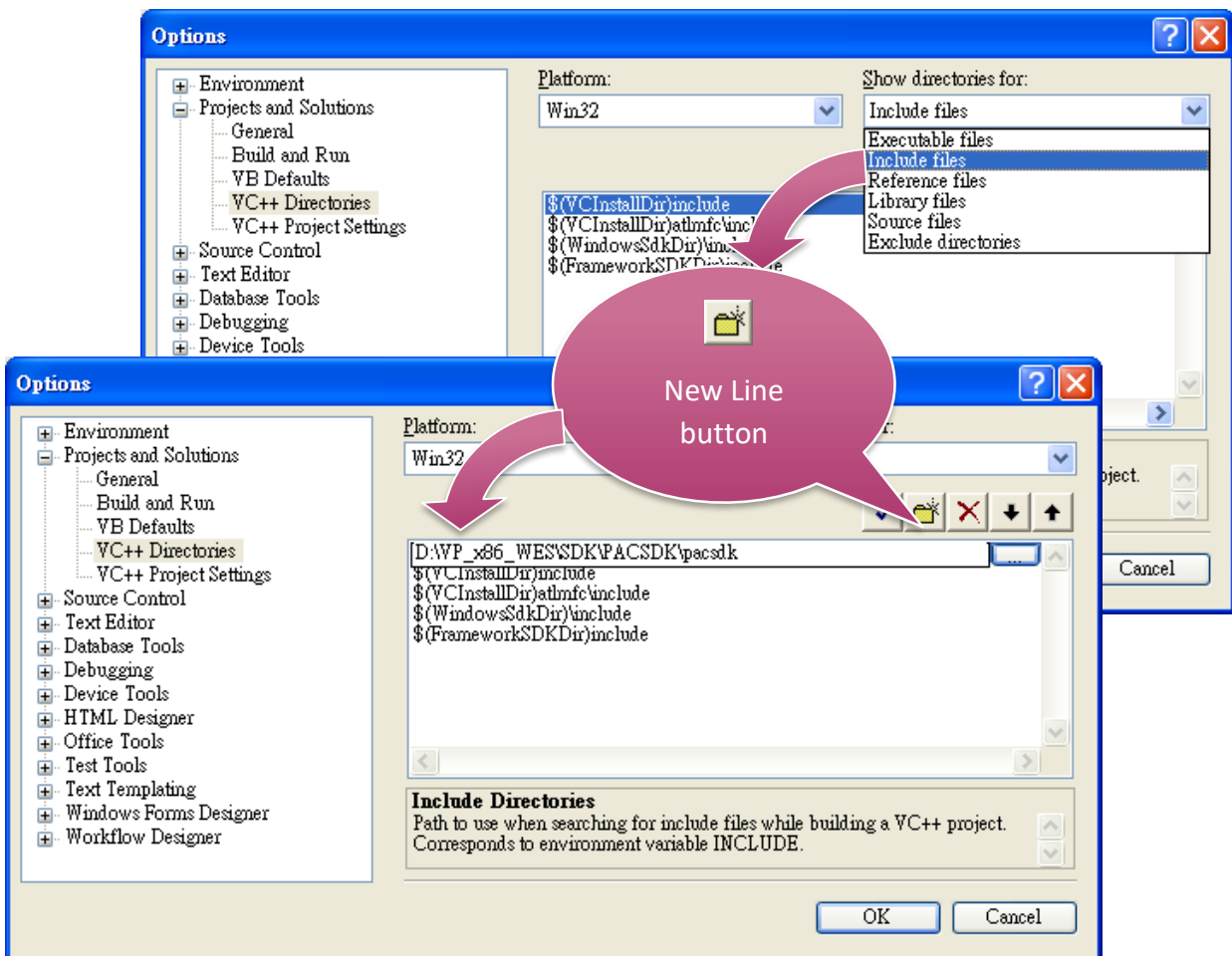

6. Select Library files in the Show directories for drop down box, and then click the New Line button

7. Add a new line to the list of directories. Browse to the directory that contains the PACSDK.lib file, and then click OK button

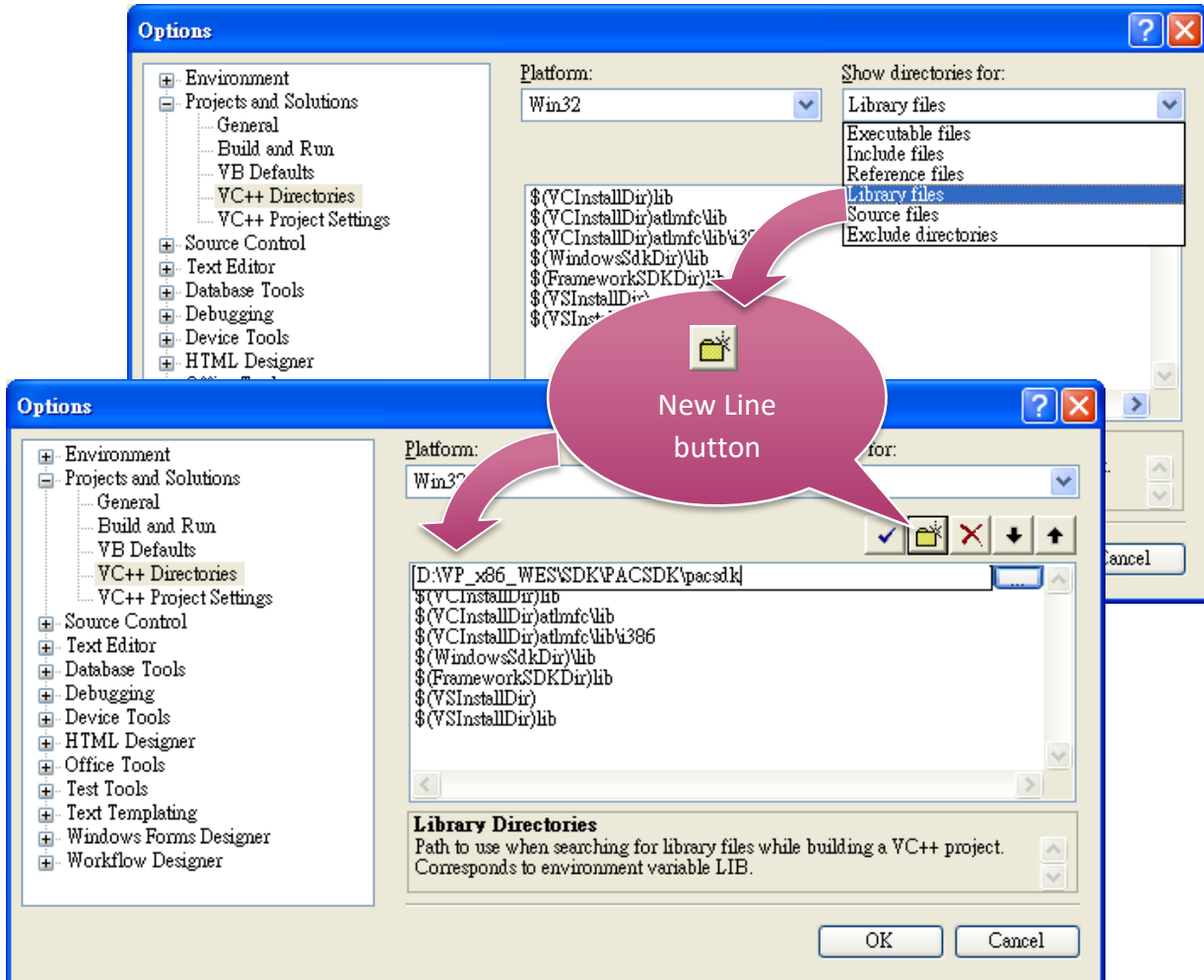

8. In the Solution Explorer windows, right-click the project name, and then click Properties

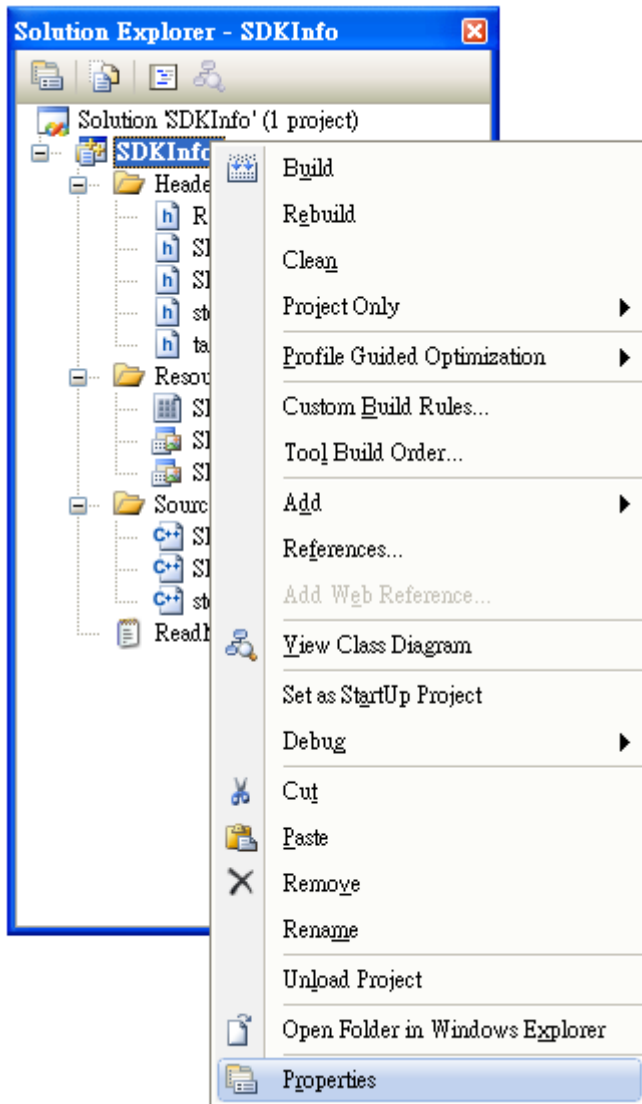

9. In the left pane, expand Configuration Properties, and then click the Link

10. In the right pane, type the PACSDK.lib in the Additional Dependencies item, click Apply button, and then click the OK button

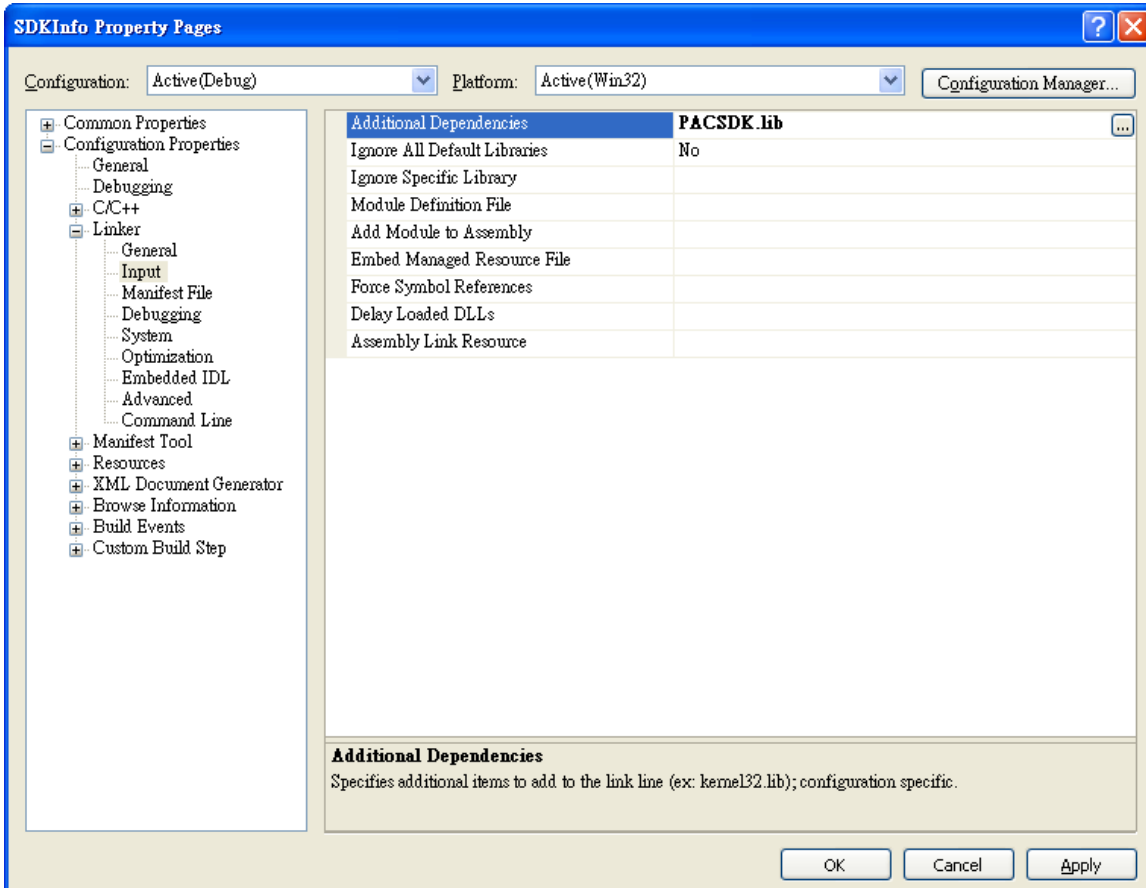

5.3.3. Add the Control to the Form

You can drag various controls from the Toolbox onto the form. These controls are not really "live"; they are just images that are convenient to move around on the form into a precise location.

After you add a control to your form, you can use the Properties window to set its properties, such as background color and default text. The values that you specify in the Properties window are the initial values that will be assigned to that property when the control is created at run time.

1. From the Toolbox, drag a Button control onto the form

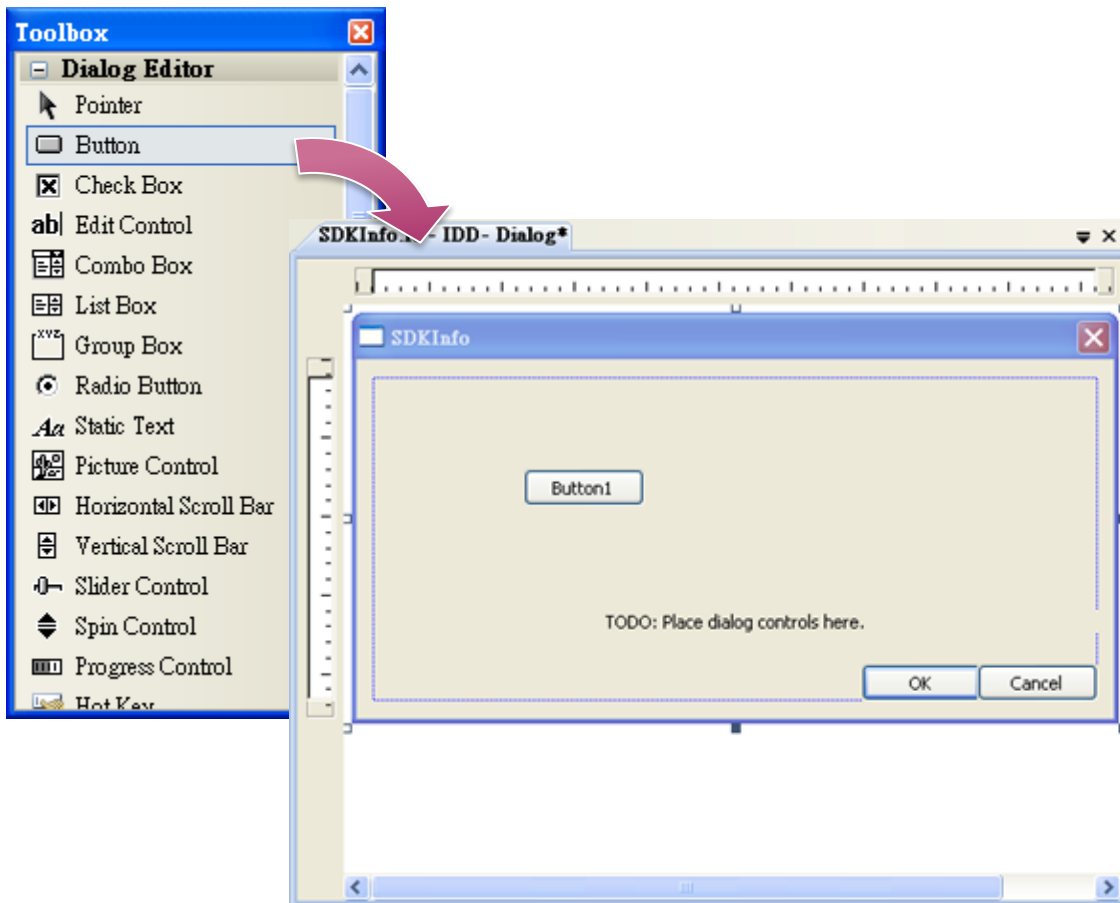

2. Right-click the Button control, and then click Properties

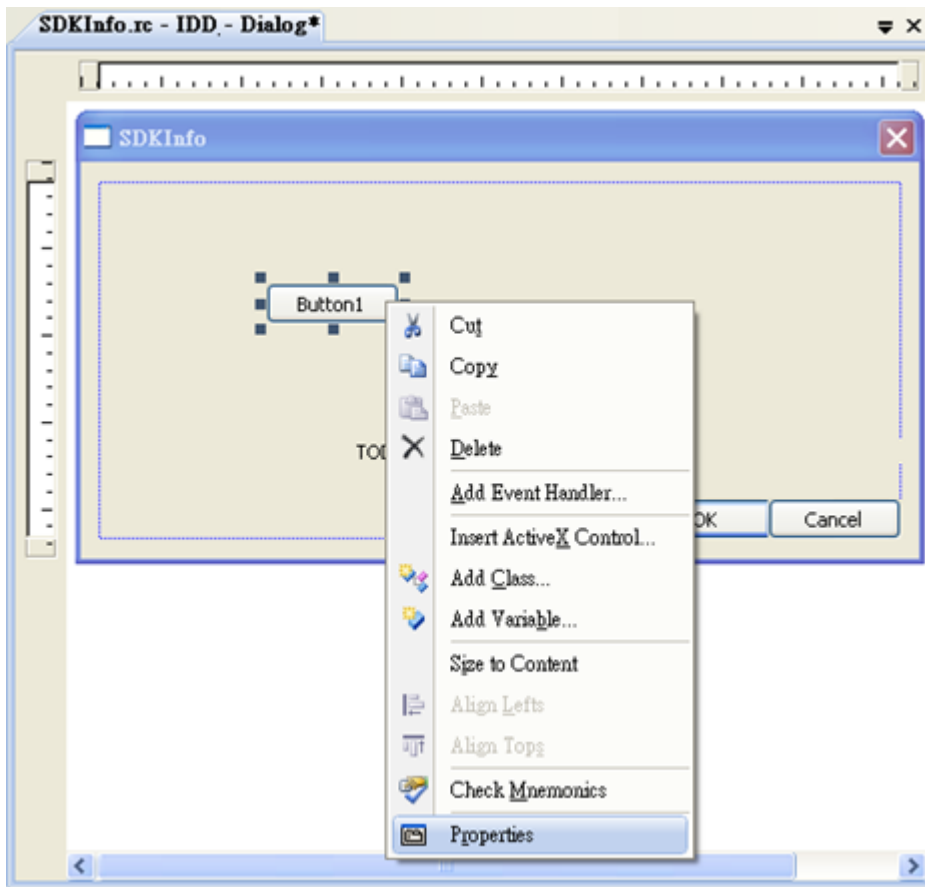

3. In the Properties window, type Check the SDK version in the Caption item, and press ENTER

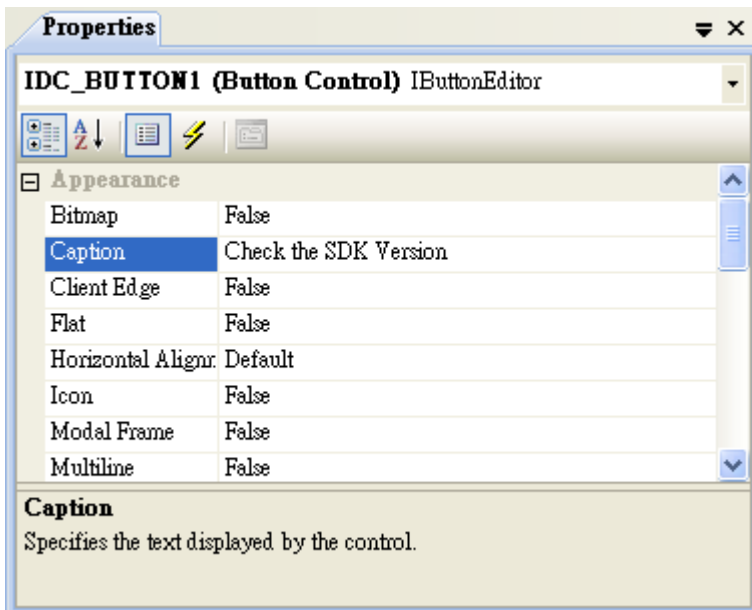

5.3.4. Add the Event Handling for the Control

You have finished the design stage of your application and are at the point when you can start adding some code to provide the program's functionality.

1. Double-click the button on the form

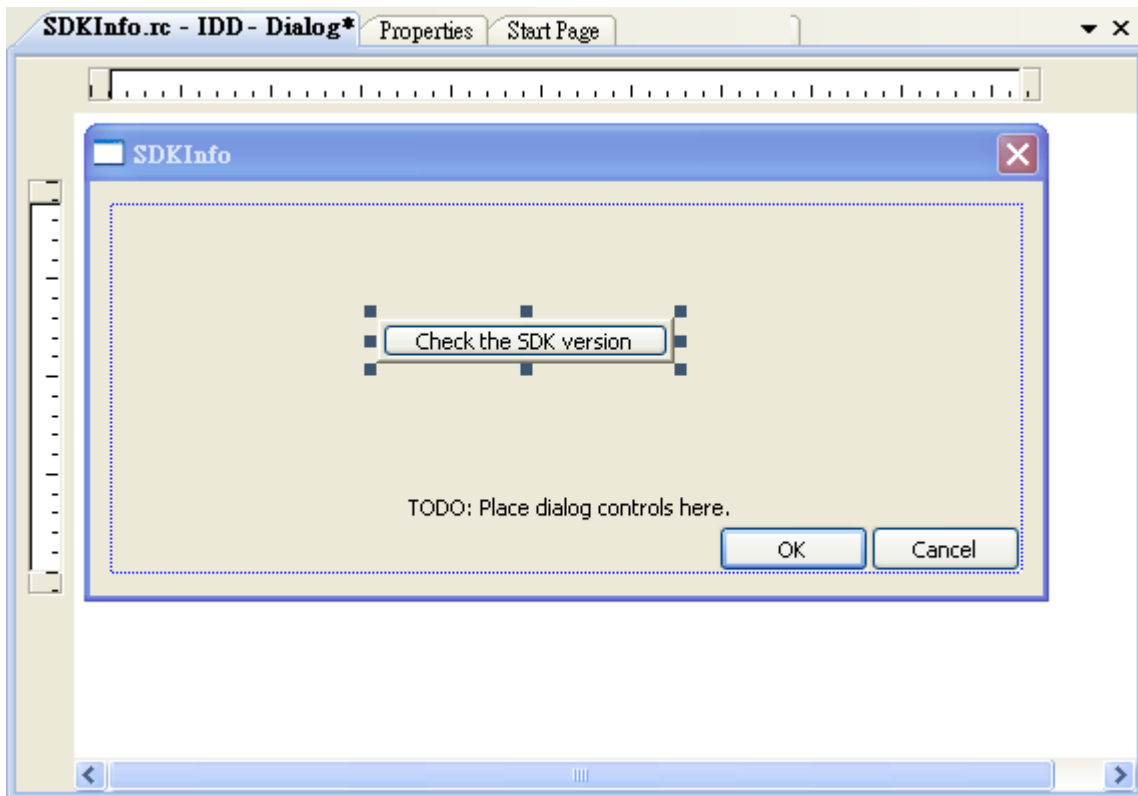

2. Inserting the following code

```
char sdk_version[32];
TCHAR buf[32];
pac_GetSDKVersion(sdk_version);
pac_AnsiToWideString(sdk_version, buf);
MessageBox(buf,0,MB_OK);
```

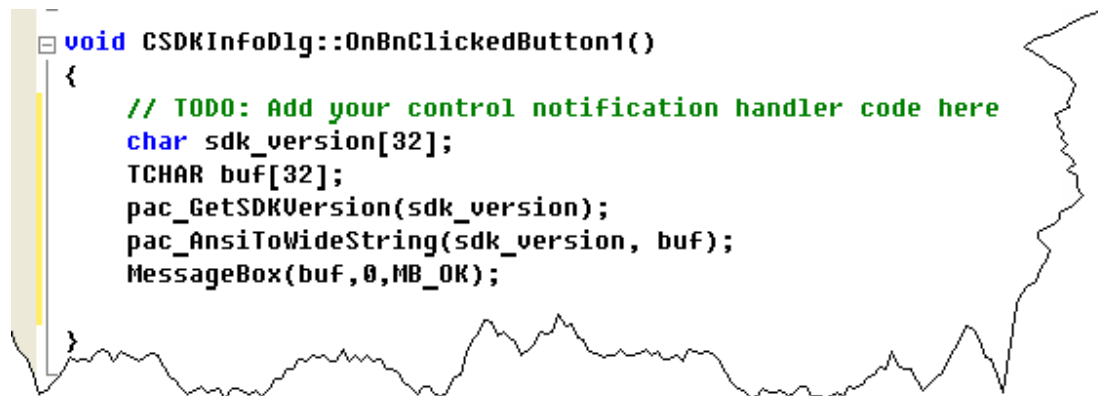

```
void CSDKInfoDlg::OnBnClickedButton1()
{
    // TODO: Add your control notification handler code here
    char sdk_version[32];
    TCHAR buf[32];
    pac_GetSDKVersion(sdk_version);
    pac_AnsiToWideString(sdk_version, buf);
    MessageBox(buf,0,MB_OK);
}
```

3. Inserting the following code into the header area

```
#include "PACSDK.H"
```

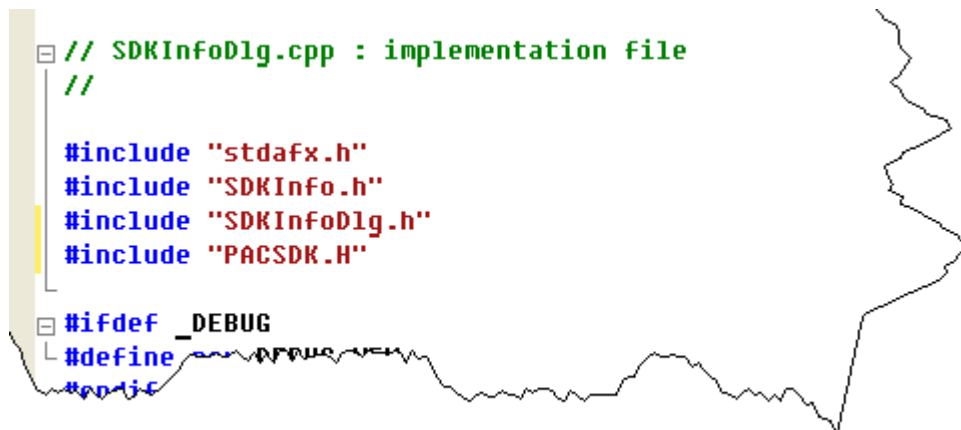

```
// SDKInfoDlg.cpp : implementation file
//
#include "stdafx.h"
#include "SDKInfo.h"
#include "SDKInfoDlg.h"
#include "PACSDK.H"

#ifdef _DEBUG
#define
#endif
```

5.3.5. Upload the Application to XP-9000-IoT

XP-9000-IoT supports FTP server service. You can upload files to XP-9000-IoT or download files from a public FTP server.

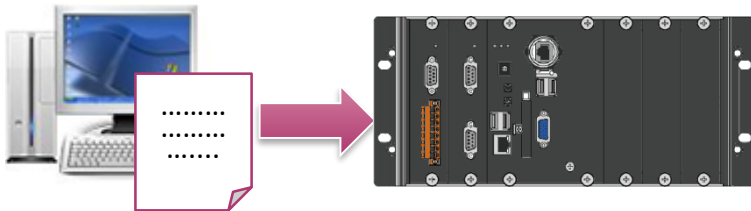

1. On the Build menu, click Build Solution

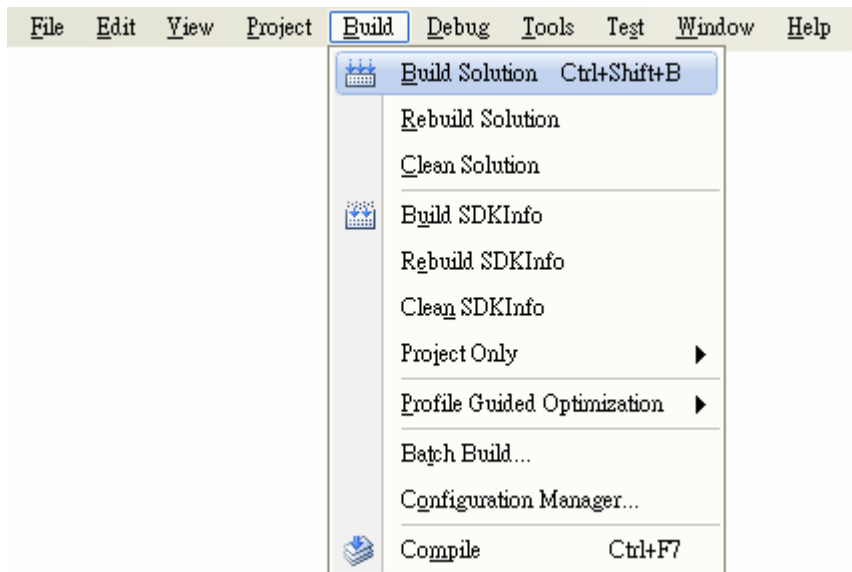

2. Open the browser and type the IP address of XP-9000-IoT

3. Upload the SDKInfo.exe application to XP-9000-IoT



5.3.6. Execute the Application on XP-9000-IoT

After uploading the application to XP-9000-IoT, you can just double-click it to execute it.

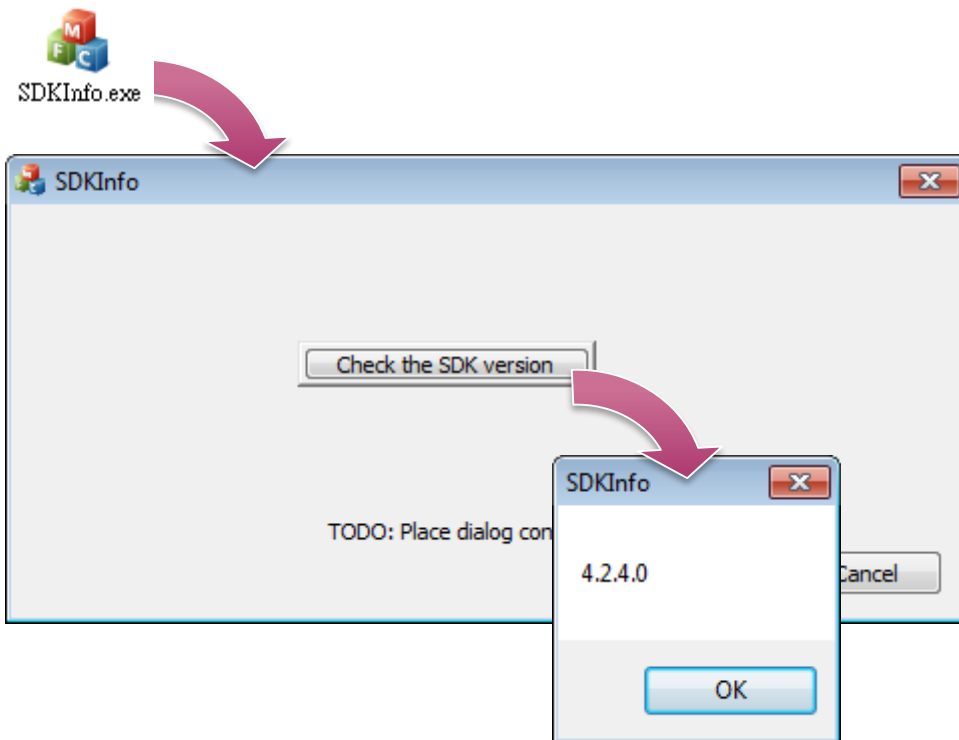

6. I/O Modules and SDK Selection

This chapter describes how to select a suitable expansion I/O module and the corresponding SDK library to be used for developing programs on XP-9000-IoT.

XP-9000-IoT provides the following I/O expansion buses:

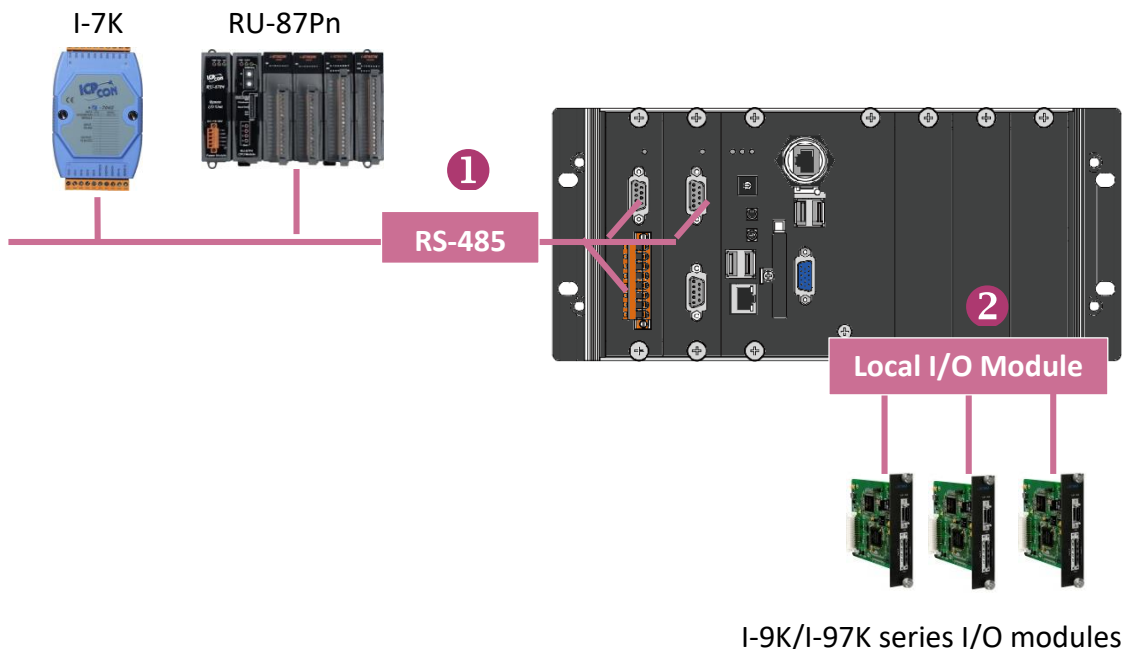

1. RS-485 (I-7000 series and M-7000 series)

I-7000, RU-87Pn and high profile I-87K series modules connect to XP-9000-IoT via a twisted-pair, multi-drop, 2-wire RS-485 network.

➤ I-7000 series I/O modules

Module	Native SDK	.NET CF SDK
I-7000 series	PACSDK.dll	PACNET.dll
I-7000 series with I-7088 (D)	PACSDK_PWM.dll	PACNET.dll

For full details regarding I-7K series I/O modules and its demos, please refer to:

註:網頁 demo 位置未知

➤ RU-87Pn + I-87K series I/O modules

Module	Native SDK	.NET CF SDK
RU-87Pn+I-87K series	PACSDK.dll	PACNET.dll

➤ Other Specified I/O

Module	Native SDK	.NET CF SDK
Others	PACSDK.dll	PACNET.dll

2. Local I/O Module (I-9K series and I-97K series)

There are two types of I/O modules that can be inserted into local bus of a XP-9000-IoT, Parallel and Serial. Parallel modules (I-9K Series) are high-speed modules and only support an MCU (Main Control Unit). Serial modules (I-97K Series) can support either an MCU or an I/O expansion unit.

The following table shows the appropriate SDK library to be used for I/O modules.

➤ I-9K series I/O modules

Module	Native SDK	.NET CF SDK
I-9014 (C)	pac_i9014W.dll	pac_i9014Wnet.dll
I-9017(C)-15	pac_i9017W.dll	pac_i9017Wnet.dll
I-9028U	pac_i9028W.dll	pac_i9028Wnet.dll
I-9093	pac_i9093W.dll	pac_i9093Wnet.dll
I-9172	pac_i9172W.dll	pac_i9172Wnet.dll
Other I-9K series	PACSDK.dll	PACNET.dll

For full details regarding I-9K series I/O modules and its demos, please refer to:

註:網頁 demo 位置未知

➤ I-97K series I/O modules

Module	Native SDK	.NET CF SDK
I-97K series	PACSDK.dll	PACNET.dll

For full details regarding I-97K series I/O modules and its demos, please refer to:

註:網頁 demo 位置未知

7. APIs and Demo Programs

This chapter provides a brief overview of PAC APIs and demo programs that have been designed for XP-9000-IoT.

ICP DAS provides a set of demo programs in different programming languages. You can examine the demo codes, which includes numerous comments, to familiarize yourself with the PAC APIs. This will allow developing your own applications quickly by modifying these demo programs.

For full usage information regarding the description, prototype and the arguments of the functions, please refer to the “PAC Standard API Manual”

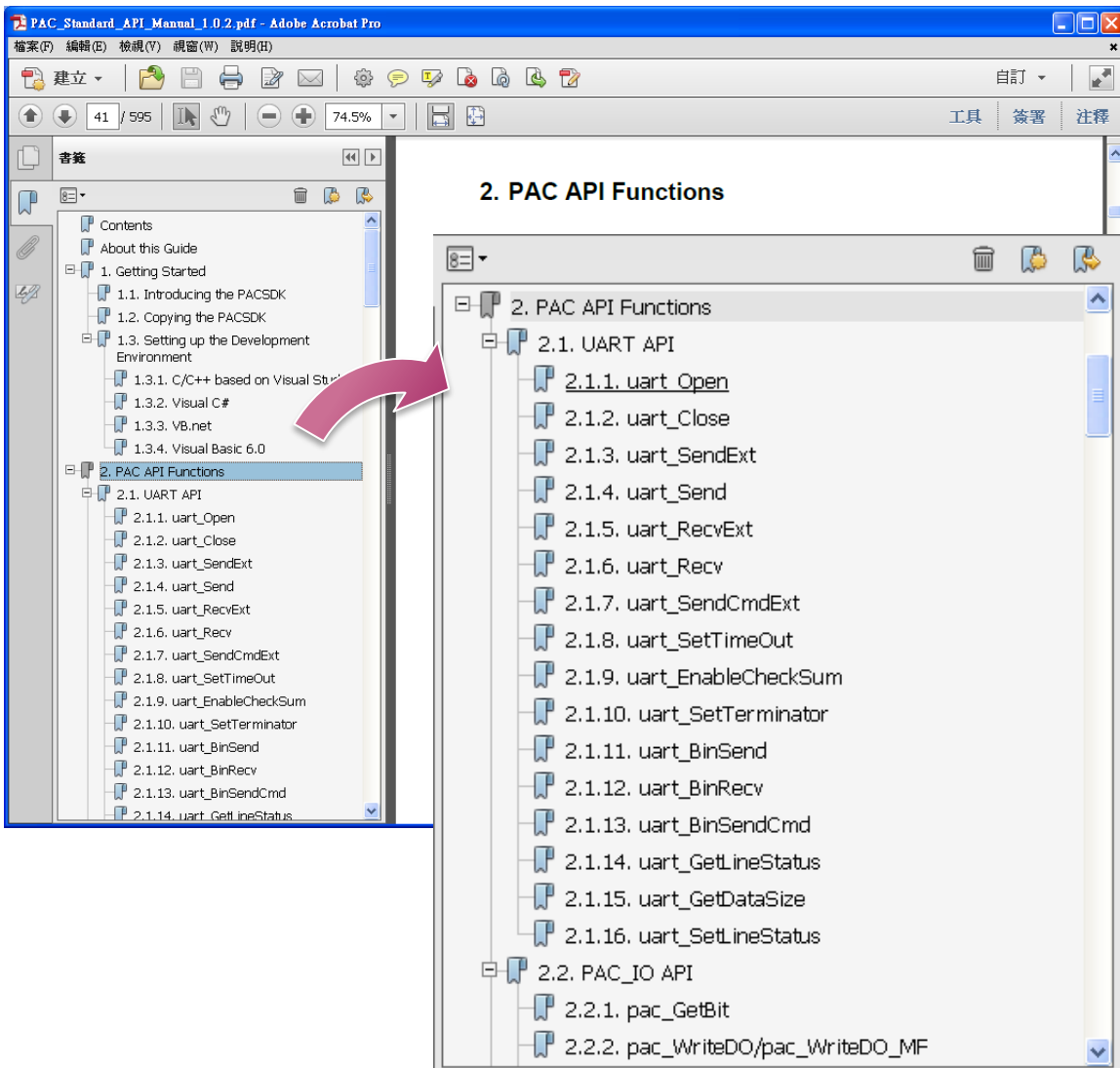

7.1. PAC Standard APIs

The diagram below shows the set of each system operation API provided in the PACSDK.

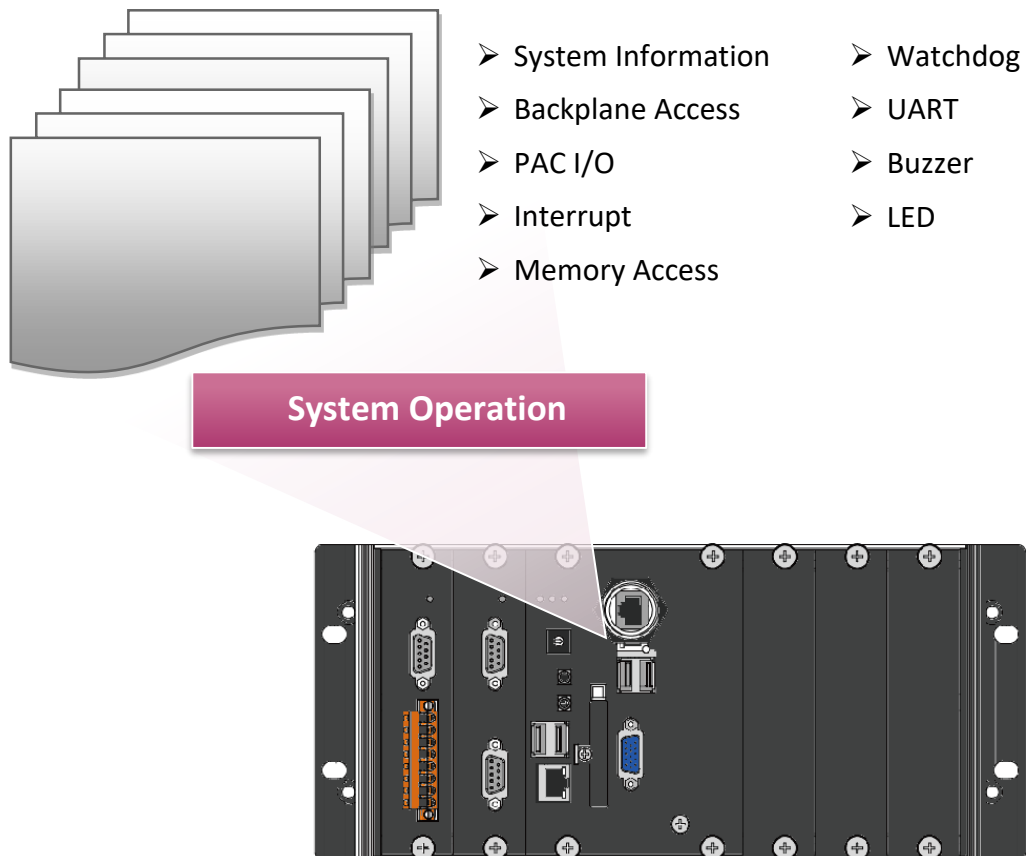

7.1.1. VB.NET Demo Programs for PAC Standard APIs

The PAC SDK includes the following demo programs that demonstrate the use of the PAC Standard APIs in a VB.NET language environment. The following demo programs can be found by downloading the latest version from ICP DAS web site.

For VB.NET applications, these demo programs can be obtained from:

<https://www.icpdas.com/en/download/index.php?model=XP-9181-IoT>

Folder	Demo	Explanation
deviceinformation	deviceinformation	Retrieves information about the OS version, the CPU version and the SDK version, etc.
diagnostic	diagnostic	Retrieves information about the slot count and the module inserted in the backplane.
dip	dip	Retrieves information about the status of the DIP switch.
getrotaryid	getrotaryid	Retrieves information about the status of the rotary switch.
memory	memory	Shows how to read/write data values from/to EEPROM.
uart	uart	Shows how to read the name of local I/O modules via UART
watchdog	watchdog	Displays information about how to operate the watchdog

7.1.2. C# Demo Programs for PAC Standard APIs

The PAC SDK includes the following demo programs that demonstrate the use of the PAC Standard APIs in a C# language environment. The following demo programs can be found by downloading the latest version from ICP DAS web site.

For C# applications, these demo programs can be obtained from:

<https://www.icpdas.com/en/download/index.php?model=XP-9181-IoT>

Folder	Demo	Explanation
deviceinformation	deviceinformation	Retrieves information about the OS version, the CPU version and the SDK version, etc.
diagnostic	diagnostic	Retrieves information about the slot count and the module inserted in the backplane.
dip	dip	Retrieves information about the status of the DIP switch.
getrotaryid	getrotaryid	Retrieves information about the status of the rotary switch.
memory	memory	Shows how to read/write date values from/to EEPROM.
uart	uart	Shows how to read the name of local I/O modules via UART
watchdog	watchdog	Displays information about how to operate the watchdog

7.1.3. Visual C++ Demo Programs for PAC Standard APIs

The PAC SDK includes the following demo programs that demonstrate the use of the PAC Standard APIs in a Visual C++ language environment. The following demo programs can be found by downloading the latest version from ICP DAS web site.

For Visual C++ applications, these demo programs can be obtained from:

<https://www.icpdas.com/en/download/index.php?model=XP-9181-IoT>

Folder	Demo	Explanation
diagnostic	diagnostic	Retrieves information about the slot count and the module inserted in the backplane.
dip	dip	Retrieves information about the status of the DIP switch.
getdeviceinformation	getdeviceinformation	Retrieves information about the OS version, the CPU version and the SDK version, etc.
GetRotaryID	GetRotaryID	Retrieves information about the status of the rotary switch.
Memory	readmemory	Shows how to read date values from EEPROM.
	writememory	Shows how to write date values to EEPROM.
uart_sendcmd	uart_sendcmd	Shows how to read the name of local I/O modules via UART
WatchDog	WatchDog	Displays information about how to operate the watchdog

7.2. PAC IO APIs

The diagram below shows the types of the PAC IO APIs provided in the PACSDK or the specified SDK.

For more information about the APIs and demo programs provided by the expansion I/O modules, please refer to chapter 6. I/O Modules and SDK Selection

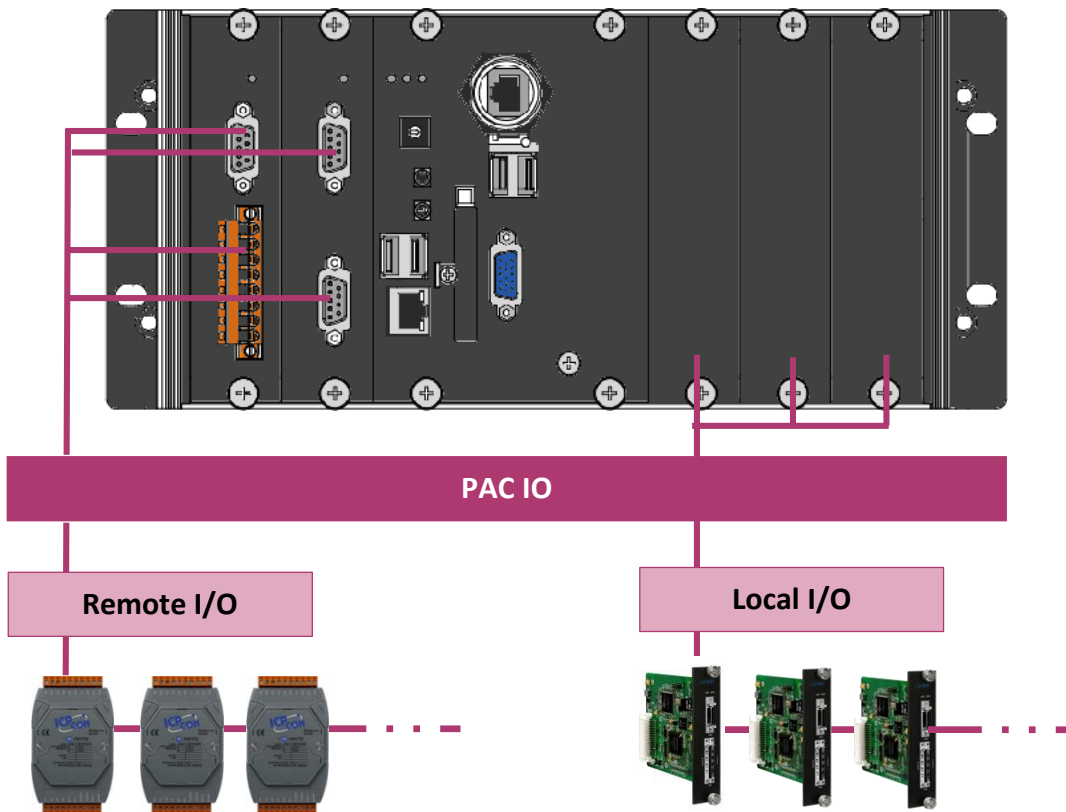

7.2.1. VB.NET Demo Programs for PAC IO APIs

The PAC SDK includes the following demo programs that demonstrate the use of the PAC IO APIs in a VB.NET language environment. The following demo programs can be found by downloading the latest version from ICP DAS web site.

For VB.NET applications, these demo programs can be obtained from:

<https://www.icpdas.com/en/download/index.php?model=XP-9181-IoT>

Folder	Demo	Explanation
Remote	7k87k_basic	Shows how to send/receive a command/response application. This demo program is used by 7K, 87K or 97K series AI modules which connected through a COM port.
	7k87k_ai	Shows how to read the AI values of AI module. This demo program is used by 7K, 87K or 97K series AI modules which connected through a COM port.
	7k87k_ao	Shows how to write the AO values to AO module. This demo program is used by 7K, 87K or 97K series AI modules which connected through a COM port.
	7k87k_di	Shows how to read the DI values of DI module. This demo program is used by 7K, 87K or 97K series AI modules which connected through a COM port.
	7k87k_do	Shows how to write the DO values to DO module. This demo program is used by 7K, 87K or 97K series AI modules which connected through a COM port.
	7k87k_dio	Shows how to read the DI and the DO values of the DIO module. This demo program is used by 7K, 87K or 97K series AI modules which connected through a COM port.

7.2.2. C# Demo Programs for PAC IO APIs

The PAC SDK includes the following demo programs that demonstrate the use of the PAC IO APIs in a C# language environment. The following demo programs can be found by downloading the latest version from ICP DAS web site.

For C# applications, these demo programs can be obtained from:

<https://www.icpdas.com/en/download/index.php?model=XP-9181-IoT>

Folder	Demo	Explanation
Remote	7k87k_basic	Shows how to send/receive a command/response application. This demo program is used by 7K, 87K or 97K series AI modules which connected through a COM port.
	7k87k_ai	Shows how to read the AI values of AI module. This demo program is used by 7K, 87K or 97K series AI modules which connected through a COM port.
	7k87k_ao	Shows how to write the AO values to AO module. This demo program is used by 7K, 87K or 97K series AI modules which connected through a COM port.
	7k87k_di	Shows how to read the DI values of DI module. This demo program is used by 7K, 87K or 97K series AI modules which connected through a COM port.
	7k87k_do	Shows how to write the DO values to DO module. This demo program is used by 7K, 87K or 97K series AI modules which connected through a COM port.
	7k87k_dio	Shows how to read the DI and the DO values of the DIO module. This demo program is used by 7K, 87K or 97K series AI modules which connected through a COM port.

7.2.3. Visual C++ Demo Programs for PAC IO APIs

The PAC SDK includes the following demo programs that demonstrate the use of the PAC IO APIs in a Visual C++ language environment. The following demo programs can be found by downloading the latest version from ICP DAS web site.

For Visual C++ applications, these demo programs can be obtained from:

<https://www.icpdas.com/en/download/index.php?model=XP-9181-IoT>

Folder	Demo	Explanation
Remote	7k87k_basic	Shows how to send/receive a command/response application. This demo program is used by 7K, 87K or 97K series AI modules which connected through a COM port.
	7k87k_ai	Shows how to read the AI values of AI module. This demo program is used by 7K, 87K or 97K series AI modules which connected through a COM port.
	7k87k_ao	Shows how to write the AO values to AO module. This demo program is used by 7K, 87K or 97K series AI modules which connected through a COM port.
	7k87k_di	Shows how to read the DI values of DI module. This demo program is used by 7K, 87K or 97K series AI modules which connected through a COM port.
	7k87k_do	Shows how to write the DO values to DO module. This demo program is used by 7K, 87K or 97K series AI modules which connected through a COM port.
	7k87k_dio	Shows how to read the DI and the DO values of the DIO module. This demo program is used by 7K, 87K or 97K series AI modules which connected through a COM port.

8. Restore and Recovery

This chapter provides information of the XP-9000-IoT restore and recovery, and a guided tour that describes the steps needed to restore and recovery the XP-9000-IoT.

The XP-9000-IoT come with a rescue CF card that can be used to not only boot the XP-9000-IoT when the OS fails to load, but also recover files.

The recovery file of the rescue CF card can be found separately by downloading the latest version from ICP DAS web site.

<https://www.icpdas.com/en/download/index.php?model=XP-9181-IoT>

8.1. Recovering the XP-9000-IoT

The XP-9000-IoT comes with a rescue CF card that can be used to restore the XP-9000-IoT to factory default settings by reinstalling the XP-9000-IoT OS image.

If the XP-9000-IoT crashes and won't start up, you can use the rescue CF card to start up the XP-9000-IoT and then fix the problem that caused the crash.

To restore the XP-9000-IoT OS

1. Plug the Rescue CF card into CF slot (XP-9000-IoT)

2. Restart the XP-9000-IoT, and then enter the BIOS by pressing Delete key

3. Press the → key to highlight the Boot tab, and then press ↓ key to select [Hard Drive BBS Priorities]

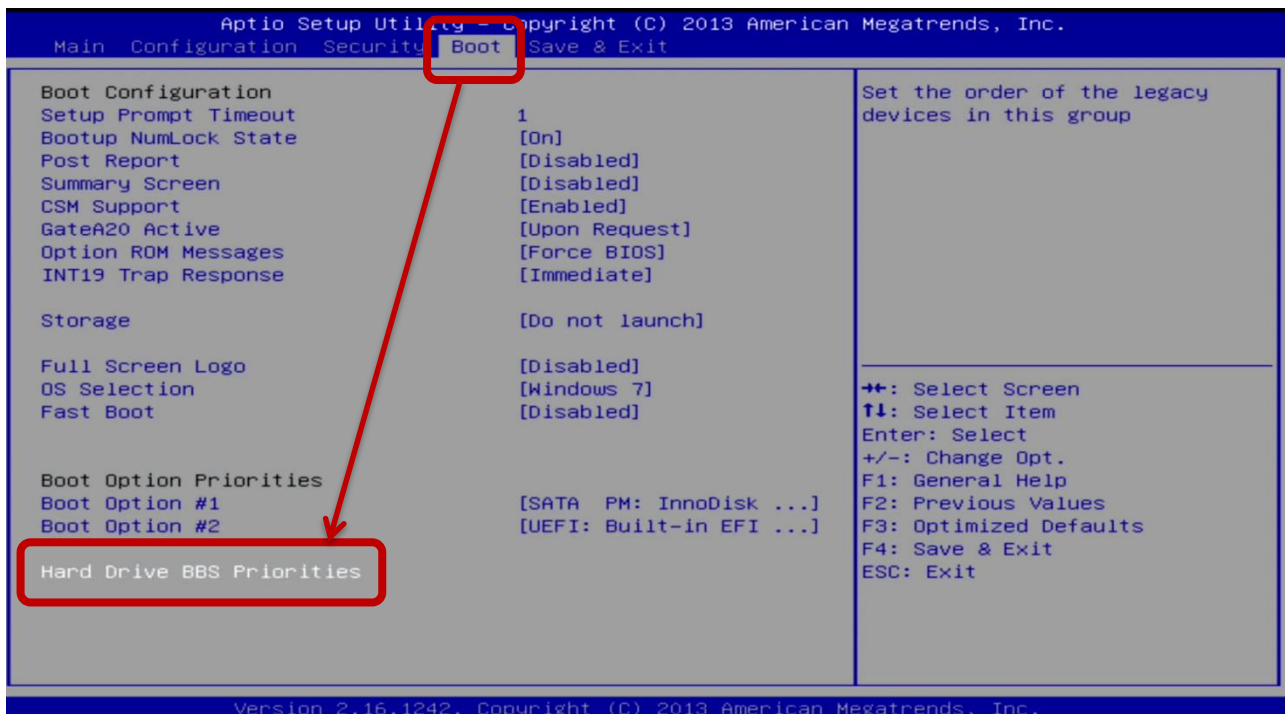

4. Press Enter on Boot Option #1, and select [CF card name]

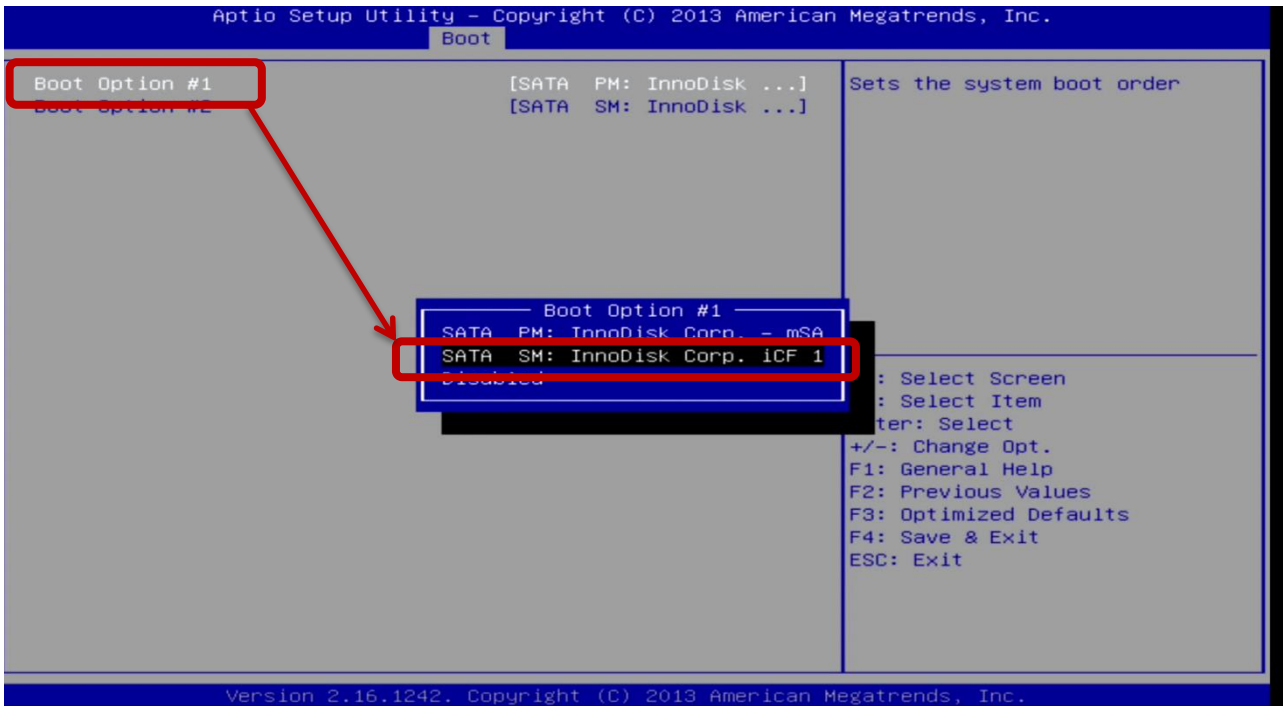

5. Press the F4 key, and then select Yes to save settings and exit the utility.

The XP-9000-IoT will restart and then enter to the XP-9000-IoT PAC Recovery Utility.

6. Check Yes and click Start XP-9000-IoT Recovery button for start the recovery process.

The process will take a few minutes until this utility is displayed again.

Windows 10 IoT PAC Recovery

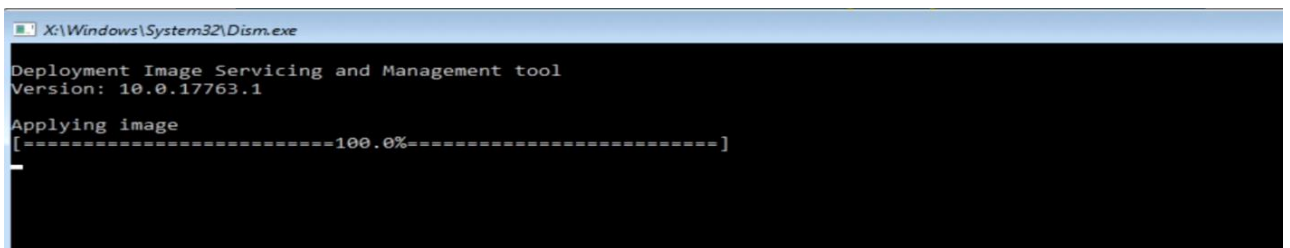
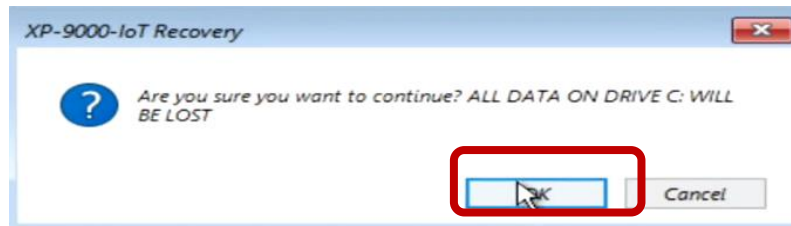
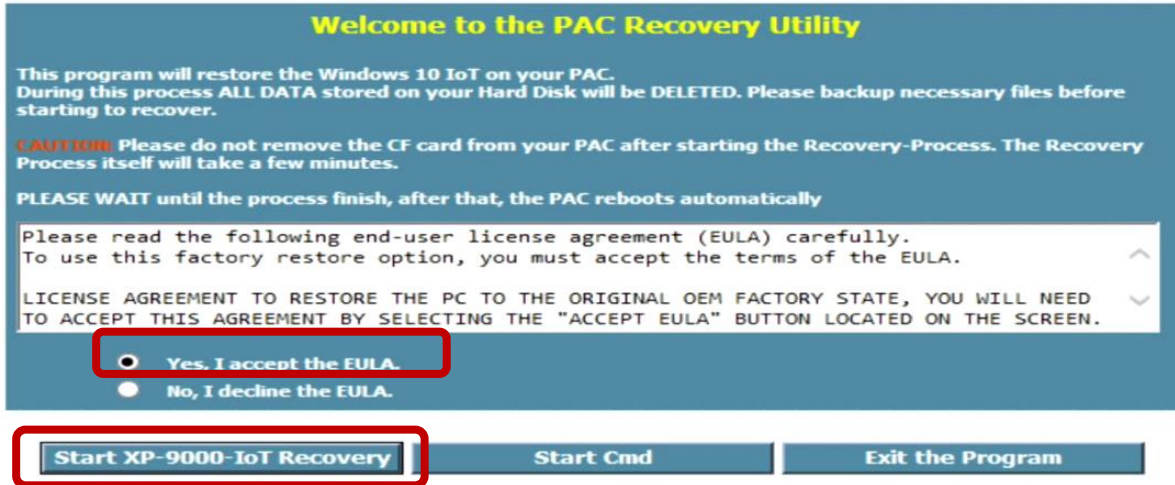

8. Click the Exit And Restart button, and then repeat the step 2 to step 5. In step 4, the [SATA PM: InnoDisk Corp. –mSA] option need be selected for using the restored disk as a boot drive. After completing the configuration process, restart the XP-9000-IoT.

Windows 10 IoT PAC Recovery

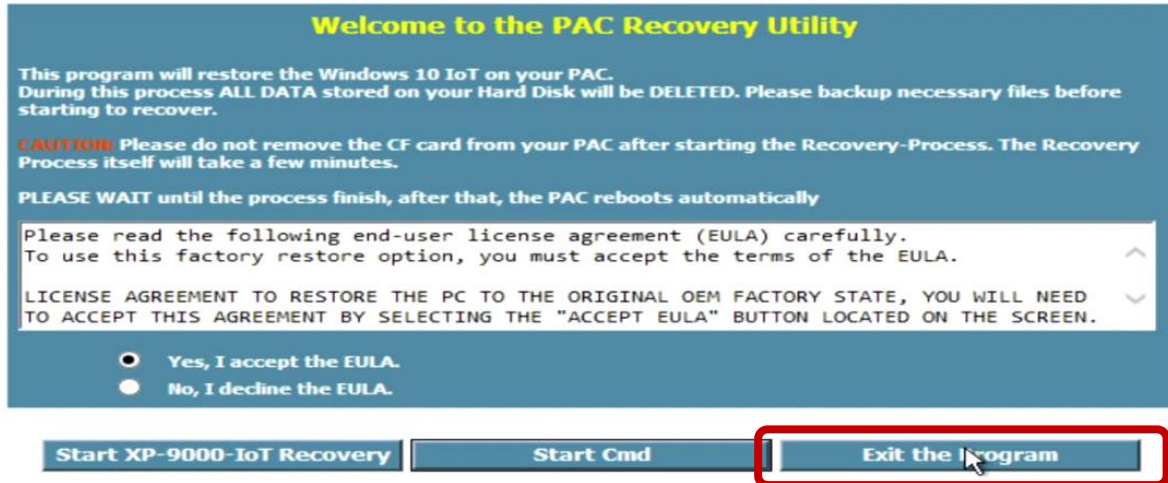

8.2. Restoring the Rescue CF Card

The rescue CF card is rescue equipment that allows you to perform some maintenance tasks on your system in case of failure.

Once the rescue CF card are partitioned or formatted, you must restore the rescue CF card.

Requirements

For restoring the Rescue CF card, you should prepare Ghost 11 or later, which you could obtain by contacting Symantec (<http://www.symantec.com>)

In this article, we will use Symantec Norton Ghost32 V.11 (The Symantec Norton Ghost V.11 or above version are recommend) to restore the rescue CF card.

To restore the rescue CF card

1. Get the rescue ghost file, rescue.gho

The rescue.gho file can be found by downloading the latest version from ICP DAS web site.

<https://www.icpdas.com/en/download/index.php?model=XP-9181-IoT>

2. Run the Symantec Ghost32, and then click OK button

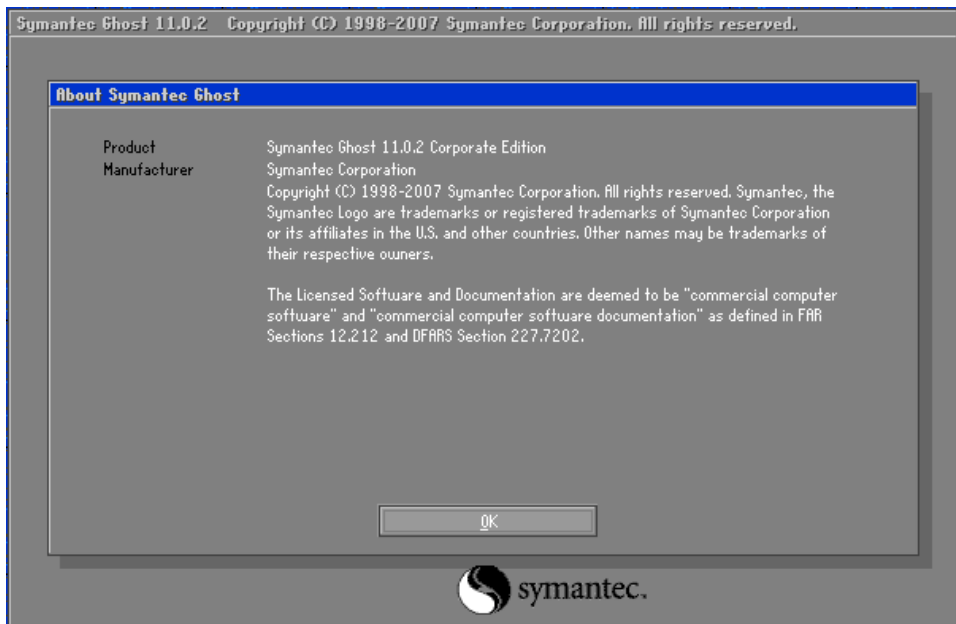

3. Click Function Menu, point to Local, point to Disk, and then click From Image

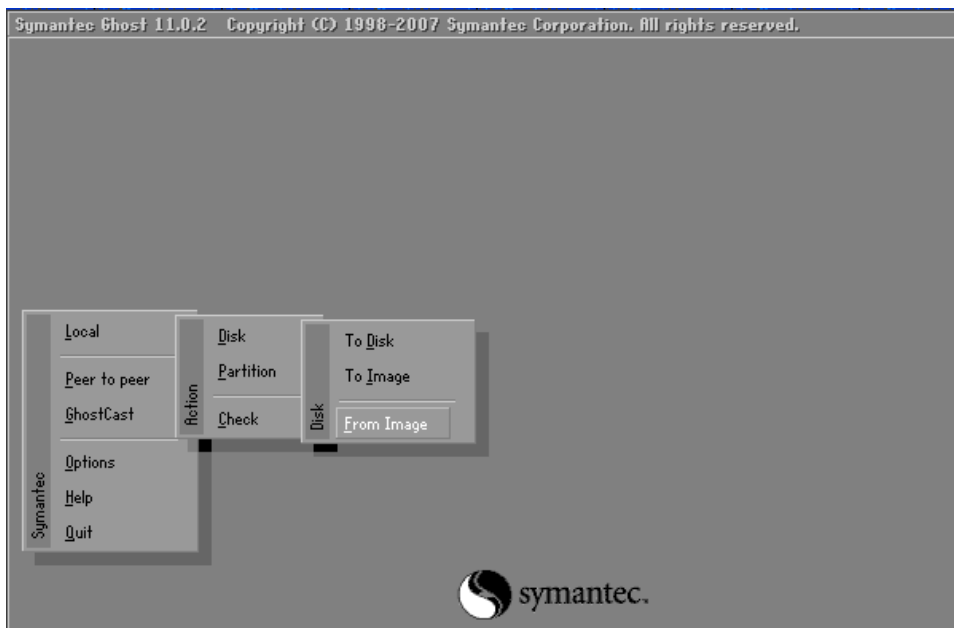

4. Select the rescue ghost file, rescue.gho, that you saved and then click Open

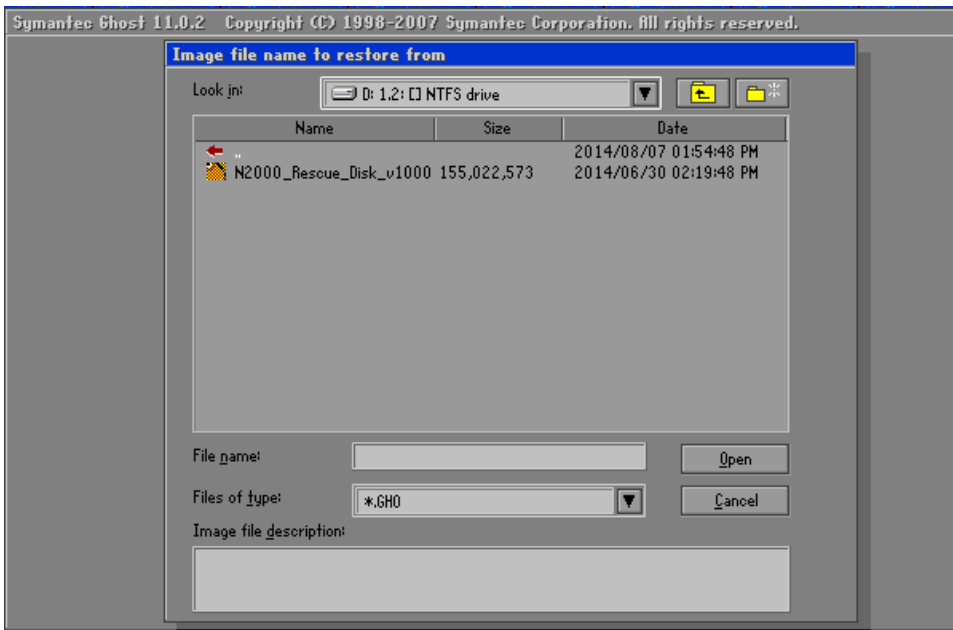

5. Select the destination to CF card and click then OK

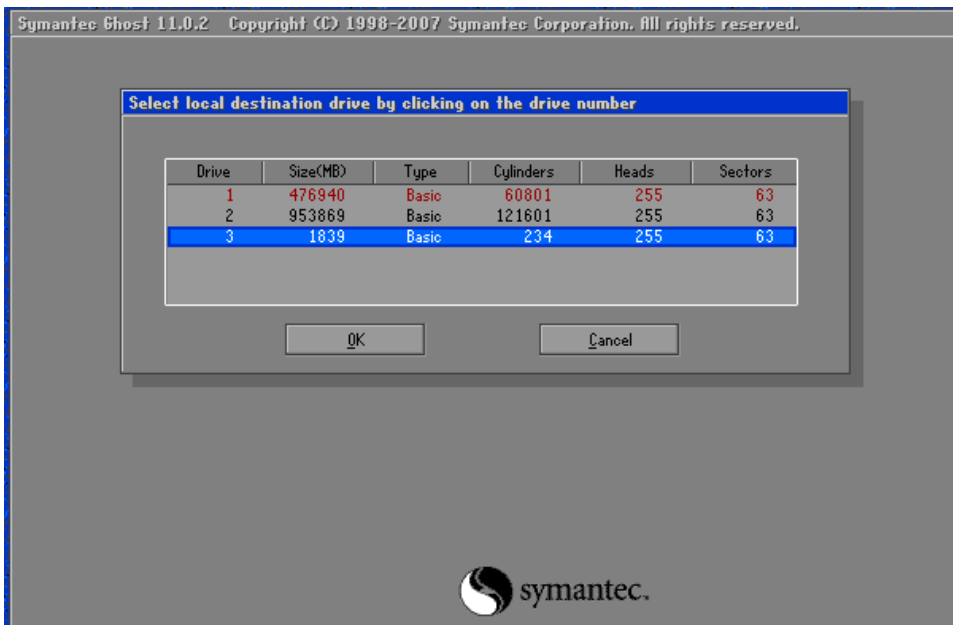

6. Recovery the rescue ghost file, rescue.gho, into CF card and then click OK

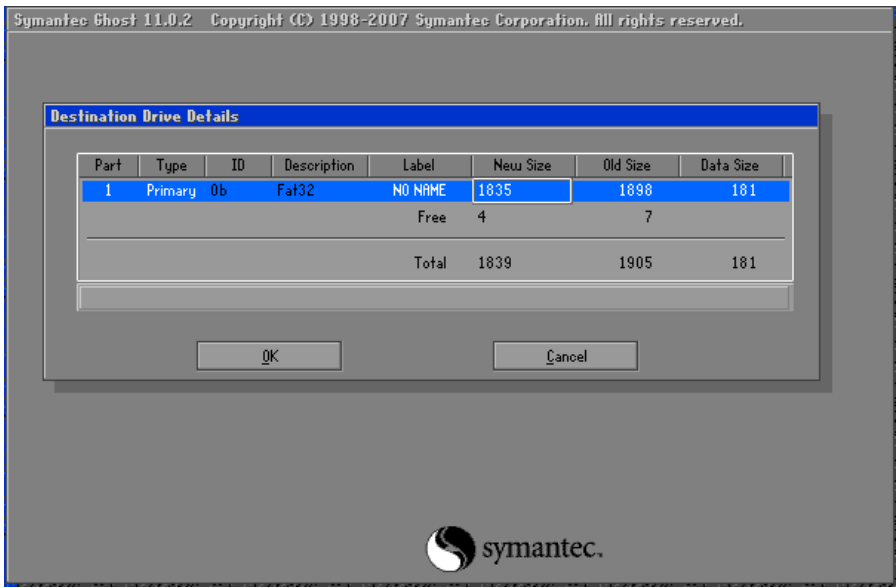

7. The rescue CF card has been done

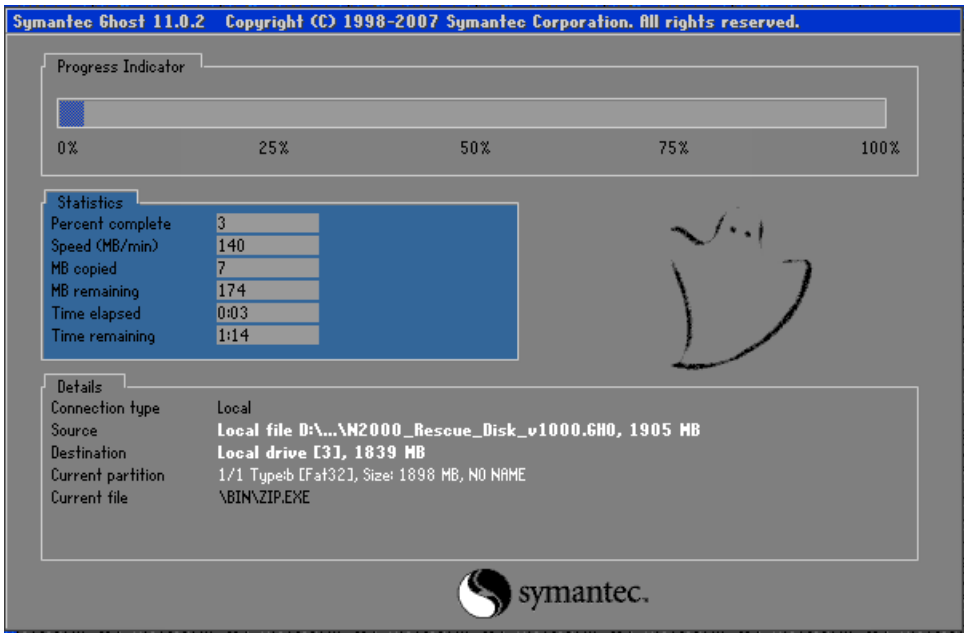

9. XP-9000-IoT Updates

This chapter provides information of the XP-9000-IoT OS, SDKs and tools, and a guided tour that demonstrates the steps needed to update the XP-9000-IoT OS, SDKs and tools.

ICP DAS will continue to add additional features to XP-9000-IoT OS, SDKs and tools in the future, so we advise you to periodically check the ICP DAS web site for the latest updates.

The files of OS updates, SDK updates and tool updates can be found by downloading the latest version from ICP DAS web site.

<https://www.icpdas.com/en/download/index.php?model=XP-9181-IoT/>

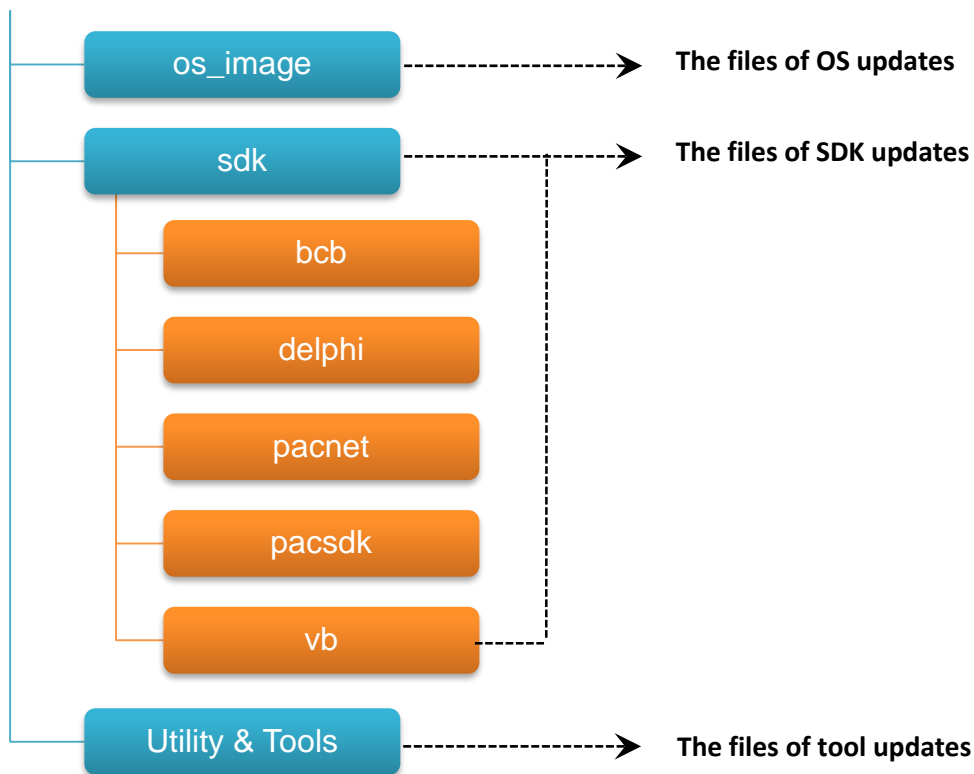

9.1. Updating the XP-9000-IoT OS

ICP DAS will continue to add additional features and improve performances to XP-9000-IoT OS in the future, so we advise you to periodically check the ICP DAS web site for the latest updates.

The information can be obtained from:

<https://www.icpdas.com/en/download/index.php?model=XP-9181-IoT>

Free feel to contact us to get the latest version of OS image.

E-mail: service@icpdas.com

9.2. Updating the XP-9000-IoT SDK



ICP DAS will continue to include more functionality and API calls to XP-9000-IoT SDK in the future, so we advise you to periodically check the ICP DAS web site for the latest updates.

To update the XP-9000-IoT SDK

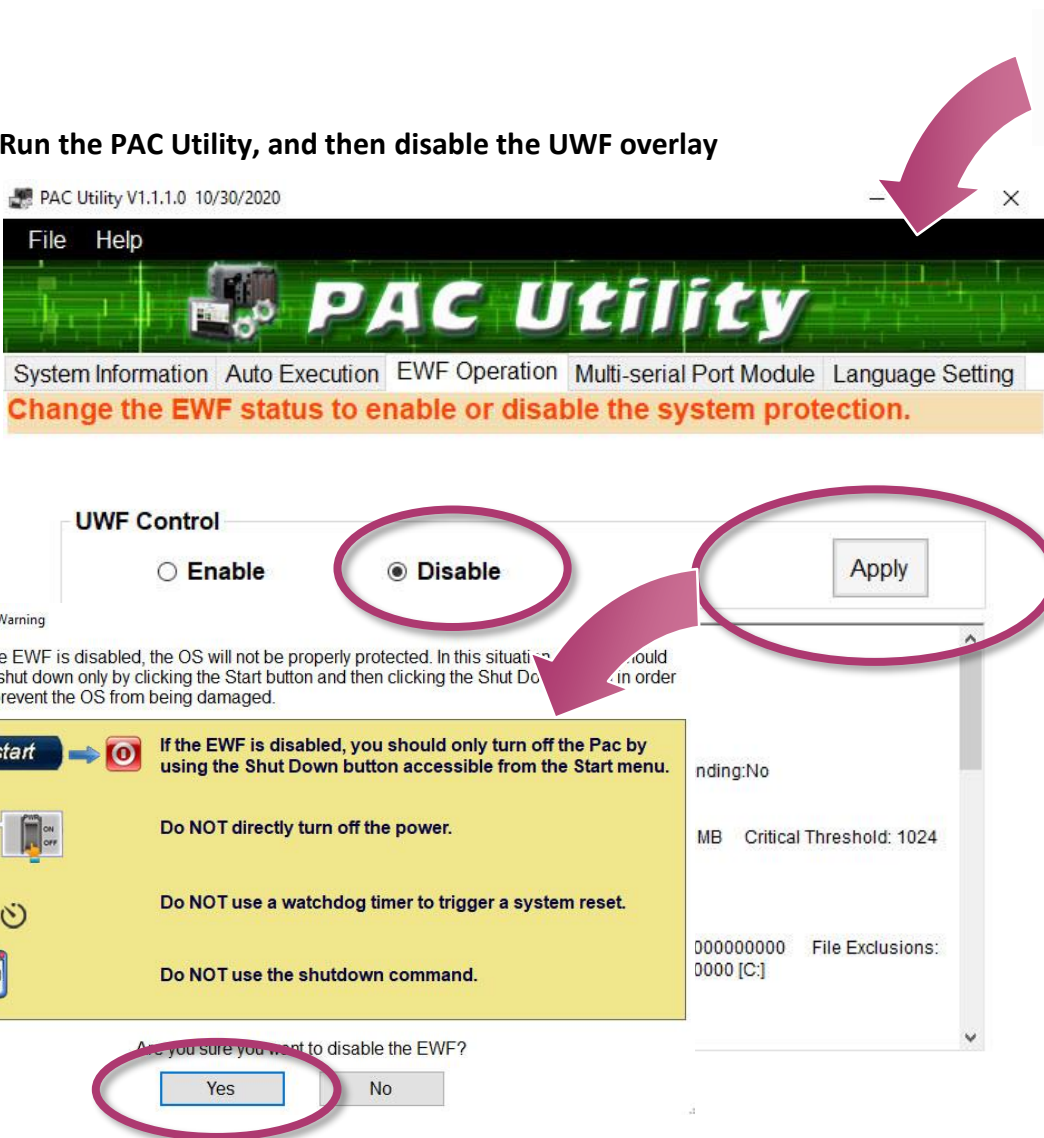
1. Run the PAC Utility, and then disable the UWF overlay



The screenshot shows the PAC Utility V1.1.1.0 application window. The title bar reads "PAC Utility V1.1.1.0 10/30/2020". The menu bar includes "File" and "Help". The main window has a green header with "PAC Utility" and a navigation bar with tabs: "System Information", "Auto Execution", "EWF Operation", "Multi-serial Port Module", and "Language Setting". A red banner at the top of the main area says "Change the EWF status to enable or disable the system protection." Below this, the "UWF Control" section has two radio buttons: "Enable" and "Disable". The "Disable" radio button is selected and circled in red. To the right of these buttons is an "Apply" button, also circled in red. Below the "UWF Control" section is a warning box titled "Disable EWF - Warning" with a red triangle icon. The warning text states: "If the EWF is disabled, the OS will not be properly protected. In this situation, you should be shut down only by clicking the Start button and then clicking the Shut Down button in order to prevent the OS from being damaged." Below the warning is a yellow box with three instructions, each with a red 'X' icon: "If the EWF is disabled, you should only turn off the Pac by using the Shut Down button accessible from the Start menu.", "Do NOT directly turn off the power.", "Do NOT use a watchdog timer to trigger a system reset.", and "Do NOT use the shutdown command." Below the yellow box is a question: "Are you sure you want to disable the EWF?" with "Yes" and "No" buttons. The "Yes" button is circled in red. A pink arrow points from the "PAC_Utility" icon in the top right to the application window. Another pink arrow points from the "Apply" button to the "Yes" button.

2. Click the Start button  , click the power button  , and then click Restart for changes to take effect.

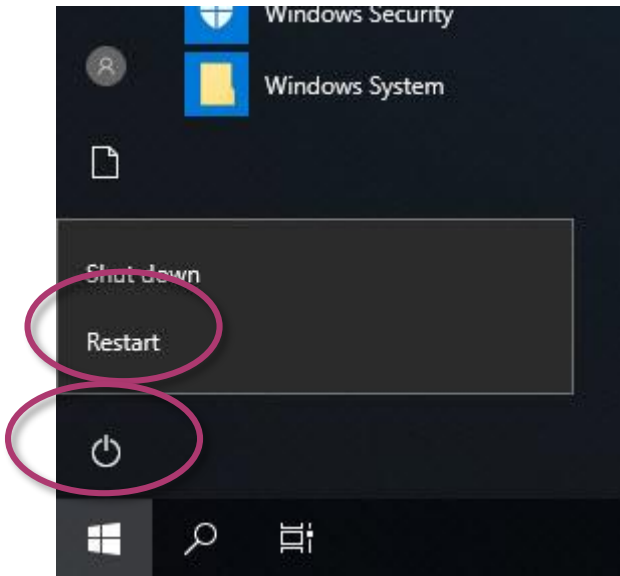

3. Download the latest version of the pacsdk.dll file

The latest version of the pacsdk.dll file can be obtained from ICP DAS web site.

<https://www.icpdas.com/en/download/index.php?model=XP-9181-IoT>

Copy the downloaded file, pacsdk.dll into the C:\Windows\System32\ folder.

This will overwrite the existing pacsdk.dll file

9.3. Updating the XP-9000-IoT Tools

ICP DAS will continue to add more functionality and support to the PAC utility in the future, so we advise you to periodically check the ICP DAS web site for the latest updates.

To update the PAC Utility

1. Download the latest version of the PAC utility file in PC or a laptop

The latest version of the PAC utility file can be obtained from ICP DAS web site.

<https://www.icpdas.com/en/download/index.php?model=XP-9181-IoT>

2. Extract the downloaded file, and then copy the file folder to the CF card

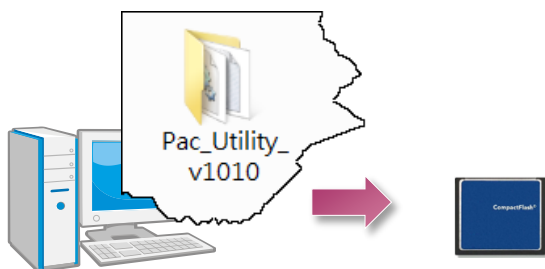



3. Plug the Rescue CF card into CF socket of XP-9000-IoT

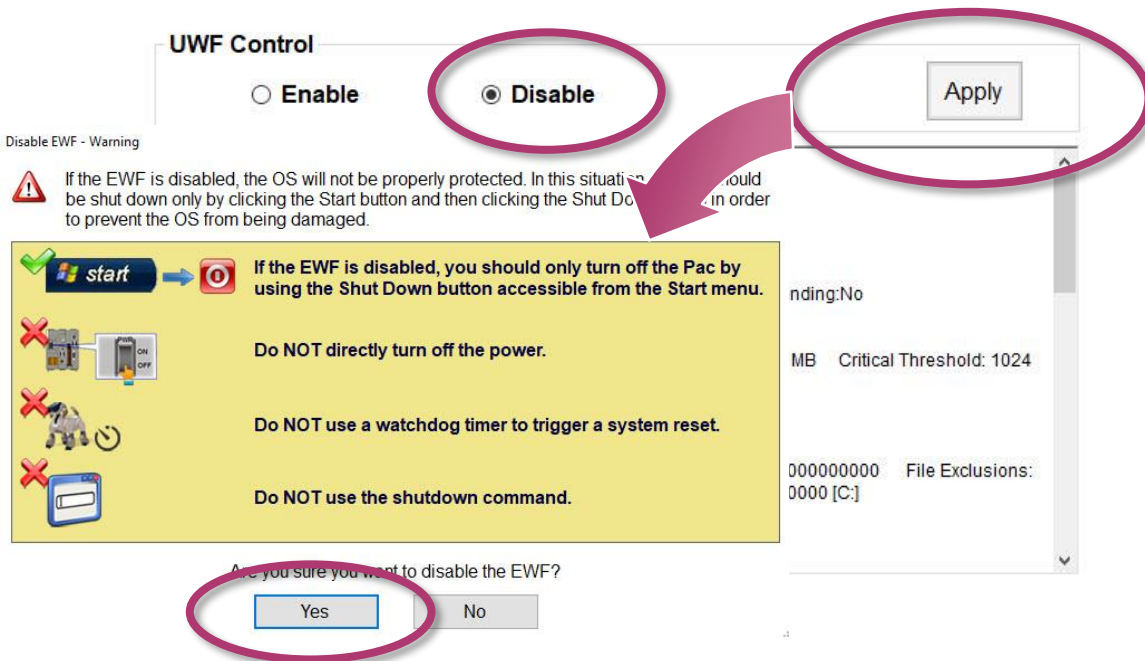
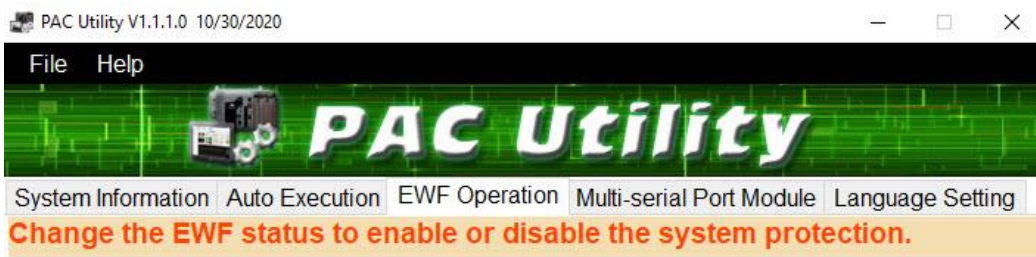

4. Run the PAC Utility, and then disable the UWF overlay



5. Click the Start button  , click the power button  , and then click Restart for changes to take effect.

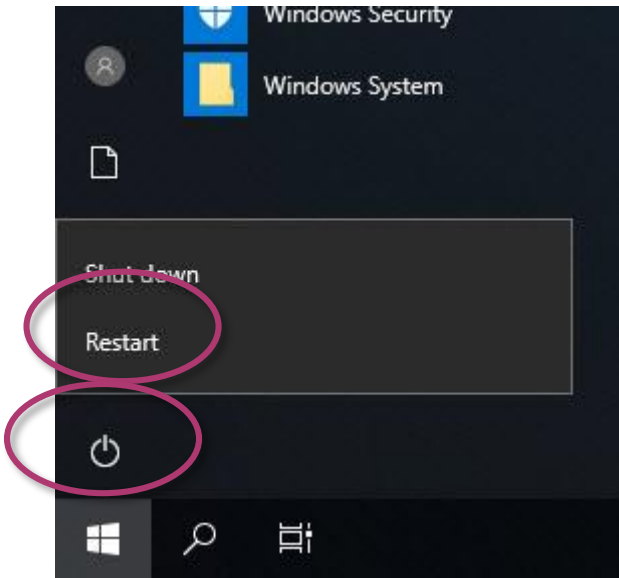

6. Copy the file folder into C:\icpdas\, and then delete the older, existing file folder

10. XP-9000-IoT Download Center

This chapter provides a brief introduction of the XP-9000-IoT download center.

XP-9000-IoT has a download center where you can access the latest version of the software, tools, demo programs, and related information.

The XP-9000-IoT Download Center can be found at:

<https://www.icpdas.com/en/download/index.php?model=XP-9181-IoT>

Download Center

About Product

PACTECH

Catalog/Flyer

Partner Zone

Download Center

Search for Subjects ▼

User Manual

FILE NAME	DESCRIPTION	MODEL	FILE DATE	LAST UPDATE	DETAIL
DCON Utility Pro	DCON Utility Pro User Manual	XP-9181-IoT	2020-11-19	2020-11-20	🔍
PAC Standard API (WES/IoT Platform)	User Manual for Windows XP/7/8/10 PC and WES PAC	XP-9181-IoT		2020-08-18	🔍

Quick Start

FILE NAME	DESCRIPTION	MODEL	FILE DATE	LAST UPDATE	DETAIL
XP-9000-IoT	Quick Start	XP-9181-IoT		2020-12-17	🔍

Data Sheet

FILE NAME	DESCRIPTION	MODEL	FILE DATE	LAST UPDATE	DETAIL

Appendix

A. I-9K Modules and I-97K Modules

This chapter provides a brief overview of the different between the I-9K series modules and I-97K series modules.

There are two types of I/O modules provided for supporting XP-9000-IoT. One is high communication speed I-9K series modules with parallel interface; the other is I-97K series modules with serial interface.

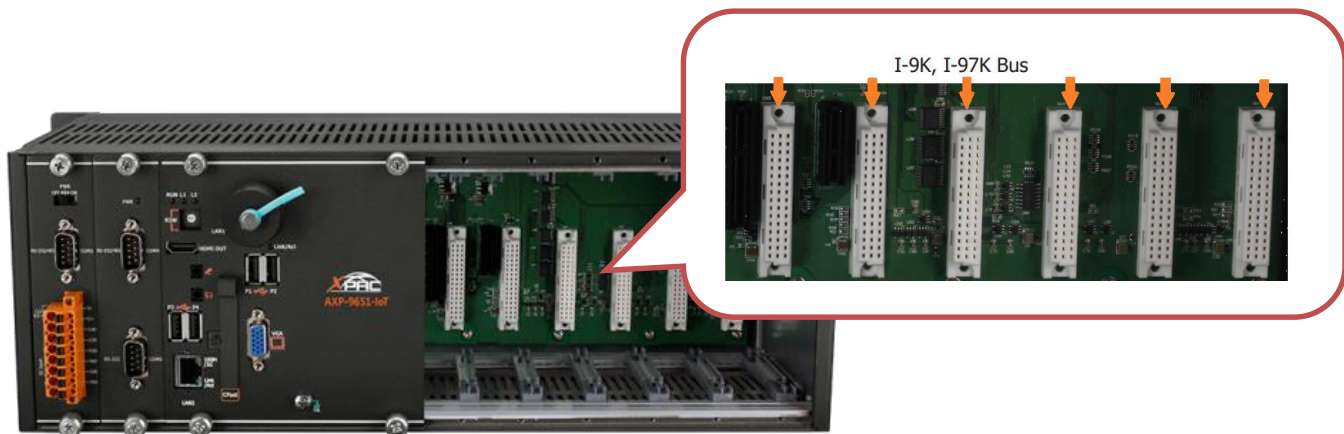
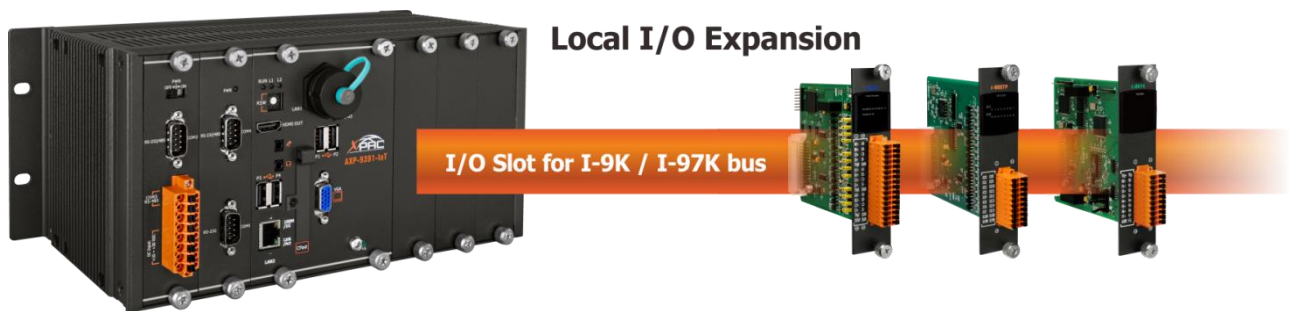

The differences between the I-9K and I-97K series I/O modules are as follows.

Item	I-9K Series	I-97K Series
Communication Interface	Parallel Bus	Serial Bus
Protocol	-	DCON
Communication Speed	Fast	Slow
DI with latched function	-	Y
DI with counter input	-	Y (100 Hz)
Power on value	-	Y
Safe Value	-	Y
Programmable slew-rate for AO module	-	Y

B. Revision History

This chapter provides revision history information to this document.

The table below shows the revision history.

Revision	Date	Created By	Description
V1.0.0	July 2015	Anna	Initial issue
V1.1.0	March 2017	Sunny	Added XP-9x71-IoT product information
V1.1.1	November 2017	Anna	Modified the information about the RJ-45 Waterproof installation in section 2.2 Installing the RJ-45 Waterproof Assembly.
V1.1.2	May 2021	Jeffery	Modified the pictures to IoT version. Modified the links to new website. Deleted section 1.5(Companion CD)