



# WP-9000-CE7 Series User Manual

V1.0.0, January 2016



**WP-9221-CE7/WP-9421-CE7/WP-9821-CE7**

Written by Sean Hsu

Edited by Anna Huang

## Warranty

---

All products manufactured by ICP DAS are under warranty regarding defective materials for a period of one year, beginning from the date of delivery to the original purchaser.

## Warning

---

ICP DAS assumes no liability for any damage resulting from the use of this product. ICP DAS reserves the right to change this manual at any time without notice. The information furnished by ICP DAS is believed to be accurate and reliable. However, no responsibility is assumed by ICP DAS for its use, not for any infringements of patents or other rights of third parties resulting from its use.

## Copyright

---

Copyright © 2016 by ICP DAS Co., Ltd. All rights are reserved.

## Trademark

---

The names used for identification only may be registered trademarks of their respective companies.

### Contact US

If you have any problem, please feel free to contact us.

You can count on us for quick response.

Email: [service@icpdas.com](mailto:service@icpdas.com)

# Contents

<b>CONTENTS.....</b>	<b>3</b>
<b>1. INTRODUCTION .....</b>	<b>6</b>
1.1. Features.....	7
1.2. Specifications .....	8
1.3. Overview .....	10
1.4. Dimensions.....	17
1.5. Companion CD.....	19
<b>2. GETTING STARTED.....</b>	<b>20</b>
2.1. Mounting the WP-9000-CE7 .....	21
2.2. Installing the RJ-45 waterproof connector assembly .....	25
2.3. Deploying a Basic WP-9000-CE7 System .....	28
2.4. Inserting the I/O Modules .....	30
2.5. Configuring the Boot Mode.....	31
2.6. Changing the User Interface Language .....	33
2.7. Using PAC Utility to Manage the WP-9000-CE7 .....	35
2.8. Using DCON Utility Pro Configure I/O Modules .....	36
<b>3. TOOLS AND TASKS.....</b>	<b>39</b>
3.1. PAC Utility.....	40
3.1.1. Menu Bar – File.....	41
3.1.2. Menu Bar – Help.....	42
3.1.3. Property Tab - General.....	43
3.1.4. Property Tab – General2.....	45
3.1.5. Property Tab – Display .....	46
3.1.6. Property Tab – IP Config .....	47
3.1.7. Property Tab – Network.....	48
3.1.8. Property Tab – Device Information.....	51
3.1.9. Property Tab – Auto Execution .....	52
3.1.10. Property Tab – Rotary Execution .....	53
3.2. DCON Utility Pro.....	54
3.3. TaskMgr.....	55
3.4. VCEP .....	56
3.5. Remote_Display .....	57
3.6. SendToCOM.....	58
3.7. RegEdit .....	59
3.8. ISQLW35 .....	60

3.9.	INotepad.....	61
<b>4.</b>	<b>YOUR FIRST WP-9000-CE7 PROGRAM.....</b>	<b>62</b>
4.1.	Setting up the Development Environment.....	62
4.1.1.	Preparing the Development Tools and Programming Languages .....	63
4.1.2.	Installing the WP-9000-CE7 SDK.....	64
4.1.3.	Setting up the Global Compiler Settings (for Visual C++) .....	65
4.2.	First WP-9000-CE7 Program in VB.NET .....	67
4.2.1.	Create a new project .....	68
4.2.2.	Specify the path of the PAC reference.....	71
4.2.3.	Add the control to the form .....	73
4.2.4.	Add the event handling for the control.....	75
4.2.5.	Upload the application to WP-9000-CE7.....	76
4.2.6.	Execute the application on WP-9000-CE7 .....	78
4.3.	First WP-9000-CE7 Program in Visual C# .....	79
4.3.1.	Create a new project .....	80
4.3.2.	Specify the path of the PAC reference.....	83
4.3.3.	Add the control to the form .....	85
4.3.4.	Add the event handling for the control.....	87
4.3.5.	Upload the application to WP-9000-CE7.....	88
4.3.6.	Execute the application on WP-9000-CE7 .....	90
4.4.	First WP-9000-CE7 Program in Visual C++ .....	91
4.4.1.	Create a new project .....	92
4.4.2.	Configure the Platform .....	97
4.4.3.	Specify the Libraries of the PAC SDK.....	98
4.4.4.	Add the control to the form .....	100
4.4.5.	Add the event handling for the control.....	103
4.4.6.	Upload the application to WP-9000-CE7.....	105
4.4.7.	Execute the application on WP-9000-CE7 .....	107
<b>5.</b>	<b>I/O EXPANSION MODULES AND SDKS SELECTION .....</b>	<b>108</b>
<b>6.</b>	<b>API RESOURCES AND DEMO REFERENCES .....</b>	<b>110</b>
6.1.	PAC Standard APIs for System Operation.....	111
6.1.1.	VB.NET Demos for PAC Standard APIs.....	112
6.1.2.	C# Demos for PAC Standard APIs.....	113
6.1.3.	Visual C++ Demos for PAC Standard APIs .....	114
6.2.	PAC Standard APIs for PAC Expansion I/O .....	115
6.2.1.	VB.NET Demos for PAC Expansion I/O.....	116
6.2.2.	C# Demos for PAC Expansion I/O.....	117
6.2.3.	Visual C++ Demos for PAC Expansion I/O .....	118

<b>7. WP-9000-CE7 UPDATES .....</b>	<b>119</b>
7.1. OS Updates.....	120
7.1.1. OS Updates from Eshell .....	121
7.1.2. OS updates using SD.....	124
7.2. SDK Updates .....	127
7.2.1. SDK Updates for VB.NET or C# .....	128
7.2.2. SDK Updates for VB.NET or Visual C++ .....	129
<b>8. WP-9000-CE7 DOWNLOAD CENTER .....</b>	<b>130</b>
<b>TIPS – HOW TO .....</b>	<b>131</b>
A. How to Use the Printer .....	132
A.1. How to Use a Network Printer.....	133
A.2. How to Use a USB printer .....	135
B. How to Online Debug the WP-9000-CE7 Program .....	136
C. How to Automatically Synchronize WP-9000-CE7 Clock with an Internet Time Server .....	141
D. How to Control the User Account Control in WP-9000-CE7.....	143
D.1. How to Create a User Account.....	144
D.2. How to Telnet to Remote Login the WinPAC from PC.....	146
D.3. How to Remove a User Account from the Login List .....	148
E. Revision History .....	149

# 1. Introduction

This chapter provides an overview of the WP-9000-CE7 and its components, and introduces the fundamental concepts for user familiar with the WP-9000-CE7.



The WP-9000-CE7 is the new generation Windows CE 7.0 based PAC (Programmable Automation Controller) of ICP DAS. Each WP-9000-CE7 is equipped with a Cortex-A8 (1.0 GHz) CPU running a Windows CE 7.0 operating system, a variant of input/output ports (VGA, USB, Ethernet, RS-232/485), and 2/4/8 expansion I/O slots that can be used to integrate high performance I-9K (parallel-type) and I-97K (serial-type) series I/O modules.

Its operating system, Windows CE 7.0, has many advantages, including hard real-time capability, small core size, fast boot speed, interrupt handling at a deeper level, achievable deterministic control and low cost. Using Windows CE 7.0 in the WP-9000-CE7 gives it the ability to run PC-based Control software such as Visual Basic.NET, Visual C#, Visual C++, SCADA software, Soft PLC and etc.

## 1.1. Features

The WP-9000-CE7 offers the most comprehensive configuration to meet specific application requirements. The following list shows the hardware and software features designed to simplify installation, configuration and application.

### Hardware Features

---

- Powerful CPU module
- Cortex-A8 1.0 GHz CPU
- Memory Size:
  - SDRAM (512 MB)
  - Flash (256 MB)
  - SD card (support up to 32 GB)
- VGA Port x 1, USB 2.0 port x 2, Series port (RS-232/RS-485) x 4
- 64-bit Hardware Serial Number
- Dual Watchdog Timers
- Dual Ethernet Ports (10 M/100 M/1000 M)
- Redundant Power Input
- Operating Temperature: -25 ~ +75 °C

### Software Features

---

- Windows Embedded Compact 7.0
- JavaScript and VBScript
- SQL Compact Edition 3.5
- .NET Compact Framework 3.5
- Remote Display
- Rich Software Solution – SDK for Microsoft Visual Studio 2008

## 1.2. Specifications

The table below summarizes the specifications of the WP-9000-CE7.

Models	WP-9221-CE7	WP-9421-CE7	WP-9821-CE7
<b>System Software</b>			
OS	Windows CE 7.0		
.Net Compact Framework	3.5		
Embedded Service	FTP Server, Web Server (Supports VB script, JAVA script), Embedded SQL Server		
SDK Provided	DII for VC, DII for Visual Studio.Net 2008		
Multilanguage Support	English, German, French, Spanish, Russian, Italian, Korean, Simplified Chinese, Traditional Chinese		
<b>CPU Module</b>			
CPU	Cortex-A8 (1.0 GHz)		
SDRAM	512 MB (DDR3)		
Flash	256 MB		
MRAM	128 KB		
EEPROM	16 KB		
SD	SD slot with one SD card		
RTC (Real Time Clock)	Provide second, minute, hour, date, day of week, month, year		
64-bit Hardware Serial Number	Yes, for software copy protection		
Dual Watchdog Timers	Yes (0.8 second)		
Programmable LED Indicator	2 (L1,L2)		
Rotary Switch	Yes (0 ~ 9)		
<b>VGA &amp; Communication Ports</b>			
VGA Resolution	800 x 600, 1024 x 768		
Dual Ethernet Ports	RJ-45, 10 M/100 M/1000 M Base-TX		
USB	USB 2.0 x 2		
COM 0	Internal communication with the high profile I-97K series modules in slots		
COM 1	RS-232/485 (RxD, TxD and GND for RS-232; Data+, Data- for RS-485); 3000 V <sub>DC</sub> isolated		



Models	WP-9221-CE7	WP-9421-CE7	WP-9821-CE7
COM 2	RS-485 (Data+, Data-); 3000 V <sub>DC</sub> isolated		
COM 3	RS-232/485 (RxD, TxD and GND for RS-232; Data+, Data- for RS-485); 3000 V <sub>DC</sub> isolated		
COM 4	RS-232 (RxD, TxD, CTS, RTS, DSR, DTR, CD, RI and GND); 3000 V <sub>DC</sub> isolated		
<b>I/O Expansion Slots</b>			
Number of I/O slots	2	4	8
Supported types of I/O modules	I-9K and I-97K series I/O Modules		
<b>Mechanical</b>			
Dimensions (W x H x D)	239 x 133 x 164	300 x 133 x 164	422 x 133 x 164
Installation	Wall and DIN-rail mounting		
<b>Environmental</b>			
Operating Temperature	-25 °C ~ +75 °C		
Storage Temperature	-30 °C ~ + 80 °C		
Ambient Relative Humidity	10 % ~ 90 % RH (non-condensing)		
Input Range	+10 V <sub>DC</sub> ~ +30 V <sub>DC</sub>		
Redundant Power Inputs	Yes		
Isolation	1 kV		
Capacity	1.5 A, 5 V supply to CPU and backplane; 6.5 A, 5 V supply to I/O expansion slots, total 40 W		
Consumption	10.8 W (0.45 A @ 24 V <sub>DC</sub> )		

### 1.3. Overview

The WP-9000-CE7 Series modules are equipped with several interfaces and peripherals that can be integrated with external systems. Here is an overview of the components and its descriptions.

#### WP-9221-CE7

---

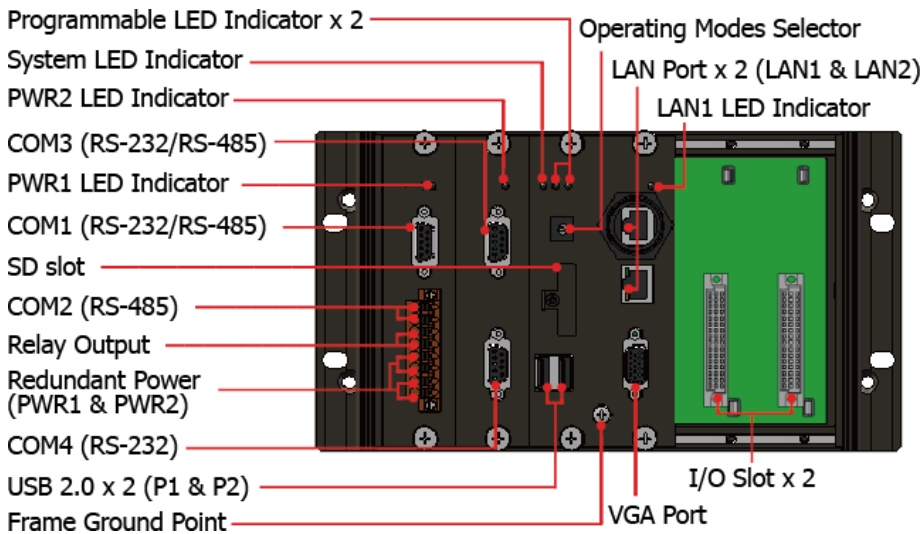

#### WP-9421-CE7

---

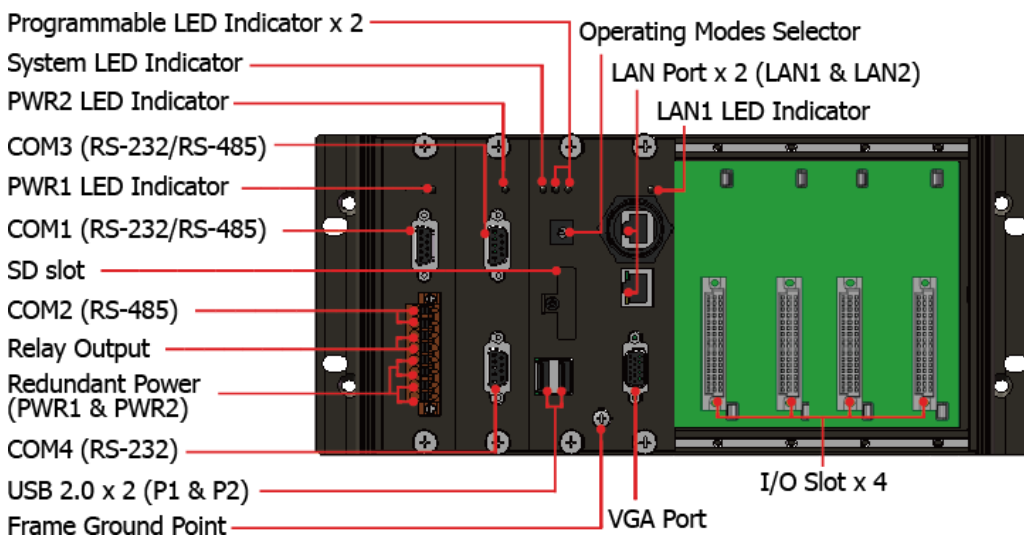

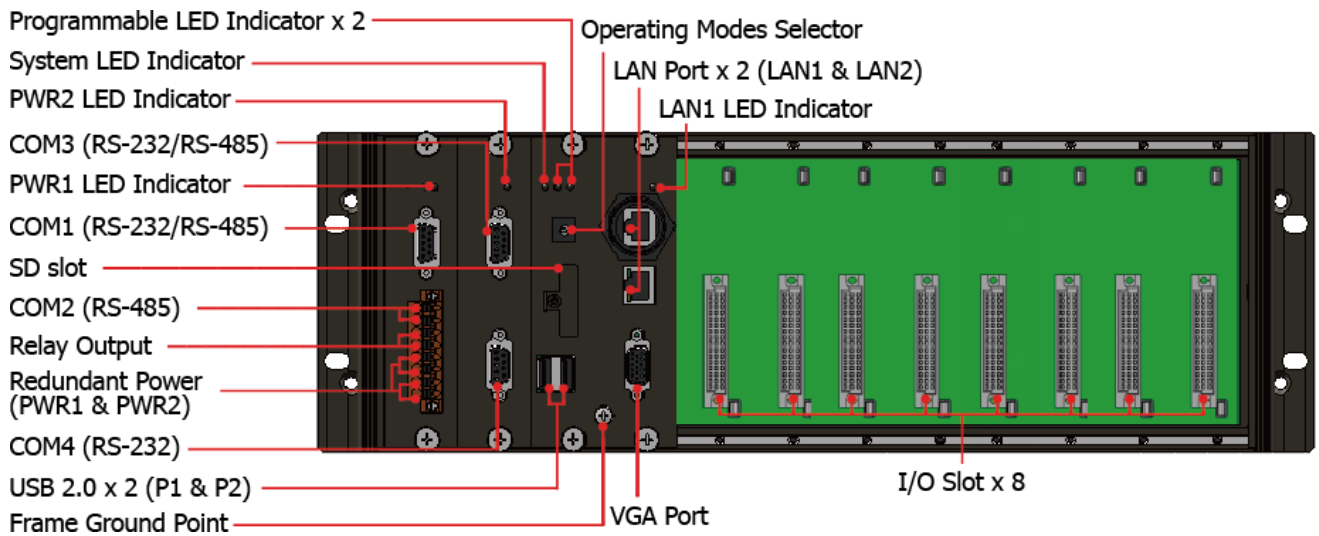

The details of these items are as follows:

### Redundant Power (PWR1 and PWR2)

The WP-9000-CE7 has a terminal with 8-wire; there are 4-wire for redundant power inputs, the details of the redundant power are shown to the side.

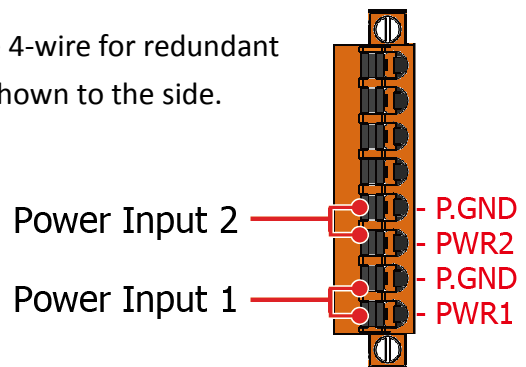

### Operating mode Selector



Rotary Switch is an operating mode selector. The WP-9000-CE7 has several operating modes, for more detailed information about these operating mode, please refer to “2.4 Configuring the Boot Mode”

## LED Indicators

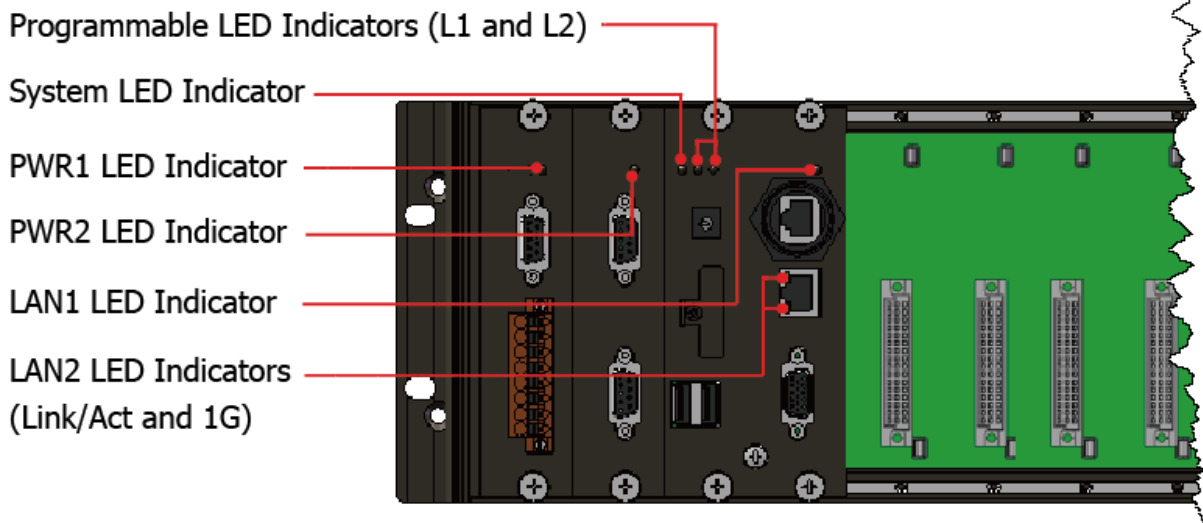

LED Indicator	Label	State (Color)	Meaning
Programmable LED Indicators	L1 and L2	-	Programmable LED indicators
System LED indicator	RUN	Orange	OS is running
PWR1 LED Indicator	PWR	Green	Power 1 is on
PWR2 LED Indicator	PWR	Green	Power 2 is on
LAN1 LED indicator	Link/Act	Green	The Link is active
		Blinking	Network activity
LAN2 LED indicator	Link/Act	Green	The Link is active
		Blinking	Network activity
	1G	Orange	The network speed is 1 G

## Communication Ports

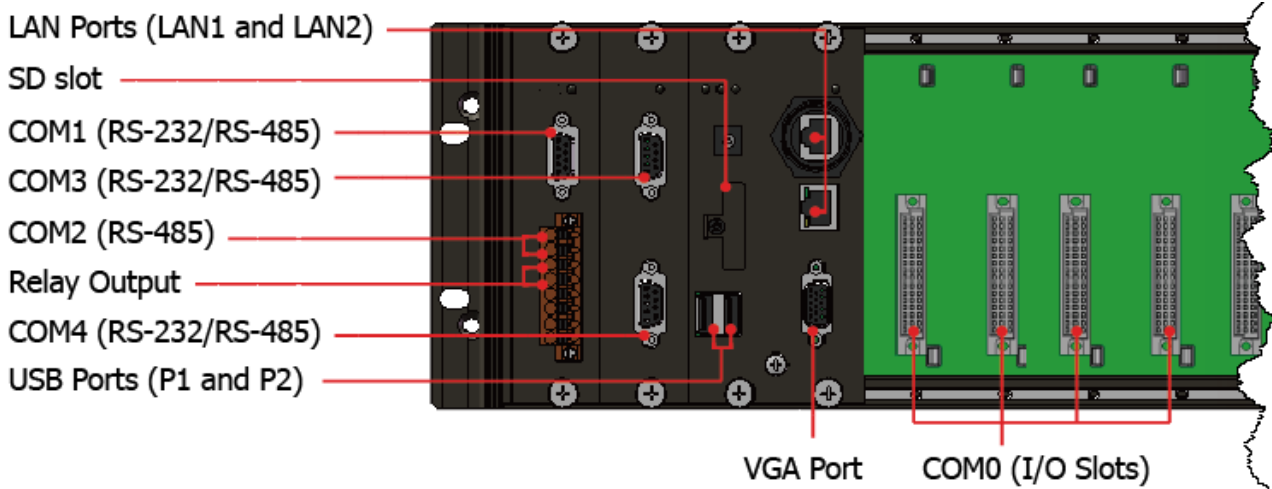

- **LAN Ports (LAN1 and LAN2)**

The WP-9000-CE7 has two Ethernet ports that can be used to connect the router to the Internet or to other devices.

- **SD slot**

The SD slot can be used to restore the WP-9000-CE7 system and expand the memory up to 32 GB.

- **USB Ports (P1 and P2)**

The WP-9000-CE7 has two USB 2.0 ports that can be used to connect the USB devices such as mouse, keyboard or an external USB hard drive.

- **Relay Output**

The WP-9000-CE7 has a relay output that can be used to control a light, siren, or other low voltage device when an alarm occurs.

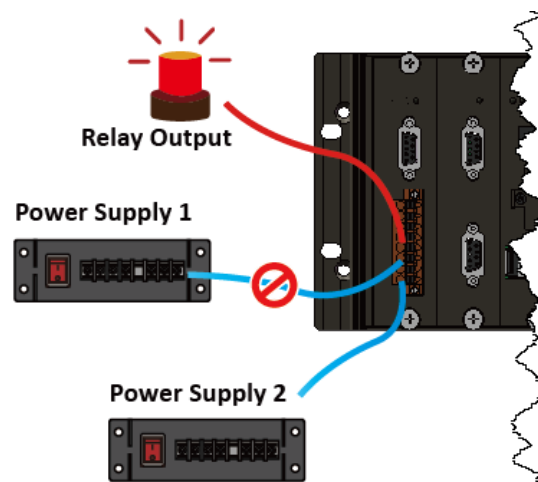

- **VGA Port**

The WP-9000-CE7 has a VGA port that can be used with a variety of supported VGA resolutions, and the output resolution covers, 800 x 600, 1024 x768.

- **COM0, Expansion I/O Slot**

The WP-9000-CE7 has 2/4/8 I/O slots that can be used to integrate high performance parallel I/O modules (high profile I-9K Series) or serial I/O modules (high profile I-97K series).

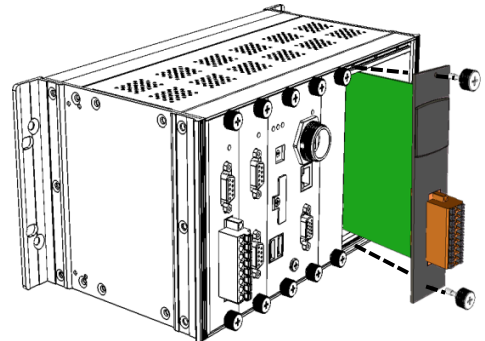

- **COM1 (RS-232/RS-485)**

The COM1 port is a 9-pins RS-232/RS-485 connector. The details of the COM1 port specifications are shown to the side.

**Note:** 16C550 compatible

**Port Type:** Male

**Baud Rate:** 115200, 57600, 38400, 19200, 9600, 4800, 2400, 1200 bps

**Data Bits:** 5, 6, 7, 8

**Parity:** None, Even, Odd, Mark (Always 1), Space (Always 0)

**Stop Bits:** 1, 2

**FIFO:** 64 bytes

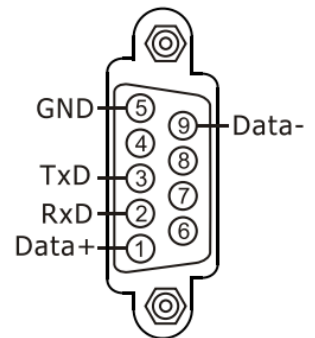

- **COM2 (2-wire RS-485)**

**Note:** 16C550 compatible

**Port Type:** Terminals

**Baud Rate:** 115200, 57600, 38400, 19200, 9600, 4800, 2400, 1200 bps

**Data Bits:** 5, 6, 7, 8

**Parity:** None, Even, Odd, Mark (Always 1), Space (Always 0)

**Stop Bits:** 1, 2

**FIFO:** 128 bytes

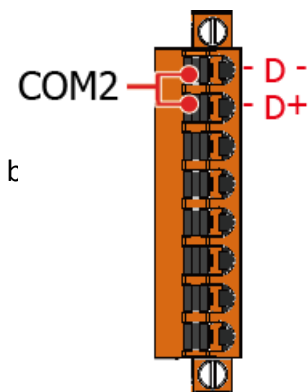

● **COM3 (RS-232/RS-485)**

The COM3 port is a 9-pins RS-232/RS-485 connector. The details of the COM3 port specifications are shown to the side.

**Note:** 16C550 compatible

**Port Type:** Male

**Baud Rate:** 115200, 57600, 38400, 19200, 9600, 4800, 2400, 1200 bps

**Data Bits:** 5, 6, 7, 8

**Parity:** None, Even, Odd, Mark (Always 1), Space (Always 0)

**Stop Bits:** 1, 2

**FIFO:** 128 bytes

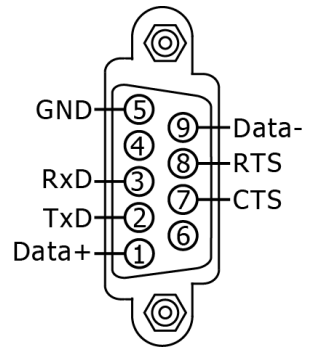

● **COM4 (RS-232)**

The COM4 port is a 9-pins RS-232 connector. The details of the COM4 port specifications are shown to the side.

**Note:** 16C550 compatible

**Port Type:** Male

**Baud Rate:** 115200, 57600, 38400, 19200, 9600, 4800, 2400, 1200 bps

**Data Bits:** 5, 6, 7, 8

**Parity:** None, Even, Odd, Mark (Always 1), Space (Always 0)

**Stop Bits:** 1, 2

**FIFO:** 128 bytes

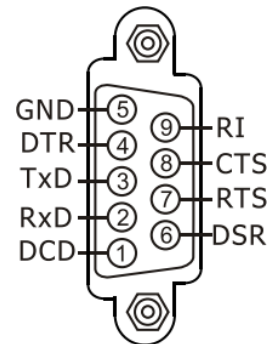

**Tips & Warnings**



The table below shows the data bit and their corresponding stop bit for COM1, COM2, COM3 and COM4.

Word Length	Number of Stop Bits
5, 6, 7, 8	1
5	1.5
6, 7, 8	2

## Frame Ground Point

---

The frame ground point is a small piece of metal that can be used to terminate the shield.

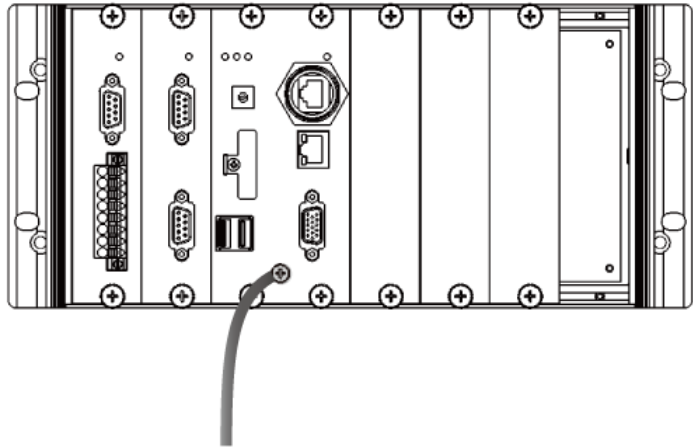



## 1.4. Dimensions

The diagrams below provide the dimensions of the WP-9000-CE7 to use in defining your enclosure specifications. Remember to leave room for potential expansion if you are using other components in your system.

The height dimension is the same for all WP-9000-CE7. The width depending on your choose of I/O expansion slots. All dimensions are in millimeters.

### WP-9221-CE7

---

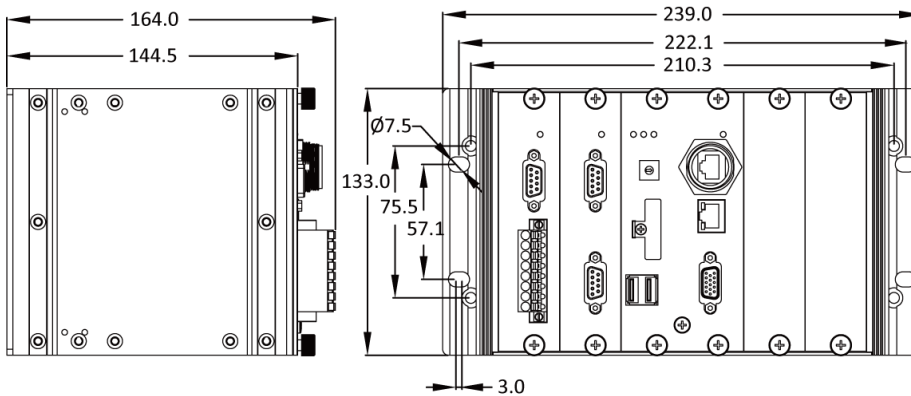

### WP-9421-CE7

---

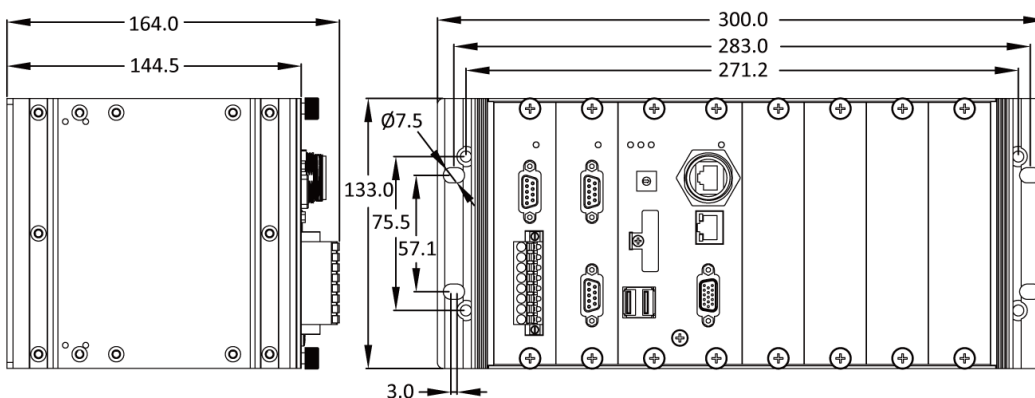

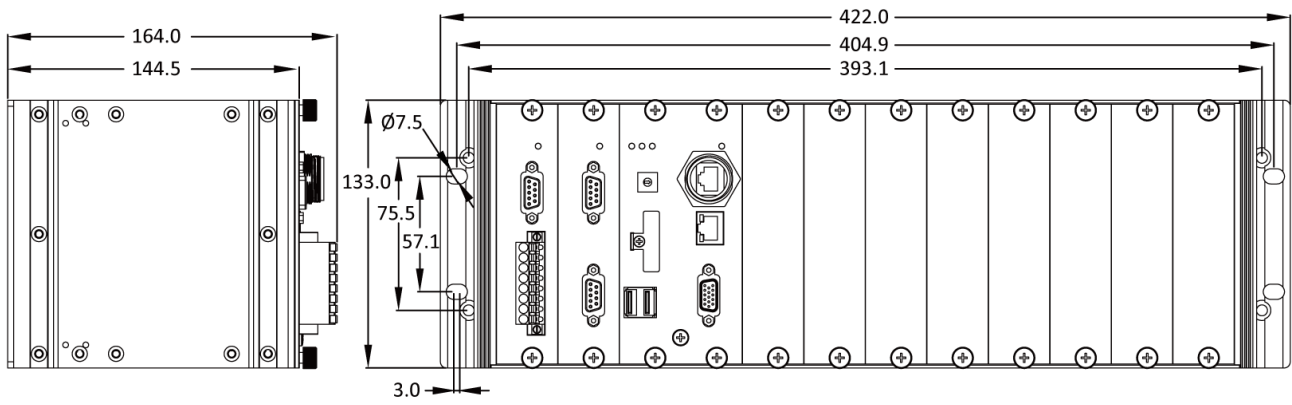

## 1.5. Companion CD

This package comes with a CD that provides a collection of the software utility, documentation, drivers, demo program and application. The CD contains several subdirectories located in \wp-9000 directory. All of them are listed below.

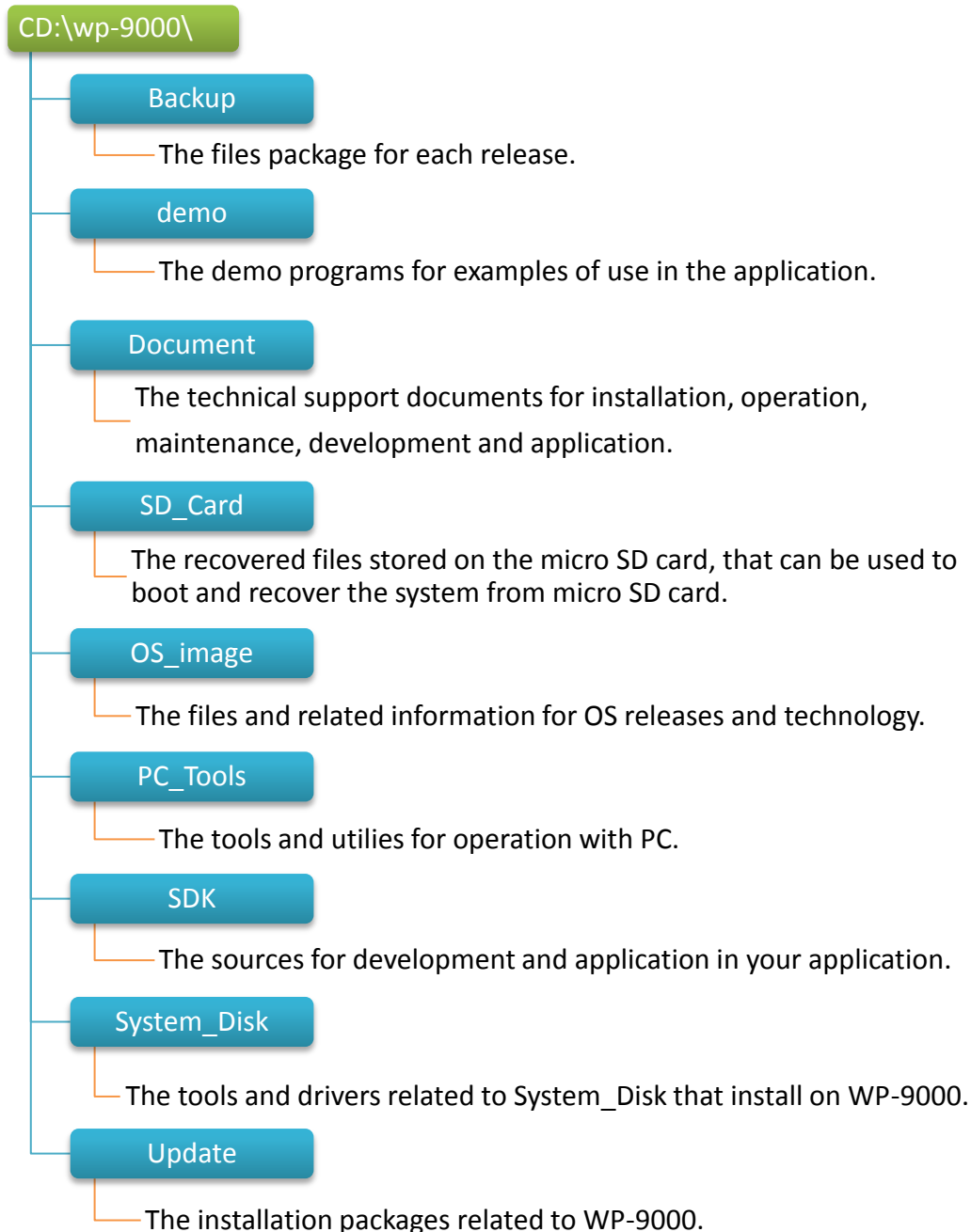

## 2. Getting Started

This chapter provides a guided tour of the WP-9000-CE7 installation and configuration that describes the steps needed to download, install, configure, and run the basic procedures for user working with the WP-9000-CE7 for the first time.

Before starting any task, please check the package contents. If any of the following package contents are missing or damaged, contact your dealer, distributor.

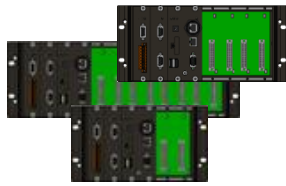

**WP-9221-CE7/WP-9421-CE7/WP-9821-CE7**

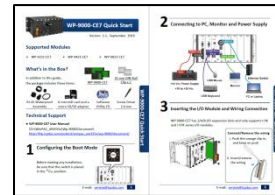

**Quick Start Guide**



**RJ-45 Waterproof Assembly**

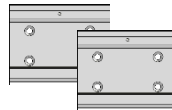

**44 mm DIN-Rail Clip \* 2**



**M3x6L Screw \* 8**



**A microSD card and a micro SD/SD adapter**



**Software Utility CD**



**Screw Driver (1C016) 2.4 mm**

## 2.1. Mounting the WP-9000-CE7

The WP-9000-CE7 can be mounted either directly to a wall/panel, or onto a stainless 35mm DIN rail.

### Wall/Panel mounting

---

**Step 1: Install the four mounting screws into the 4 keyhole mounting holes**

**Step 2: Fasten the screws securely**

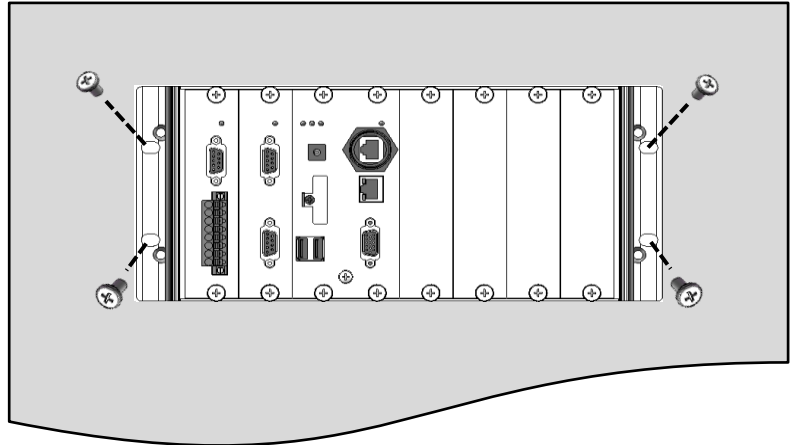

### Tips & Warnings

---



There must be a minimum clearance of 50mm between the WP-9000-CE7 and the top and bottom side of the enclosure panel.

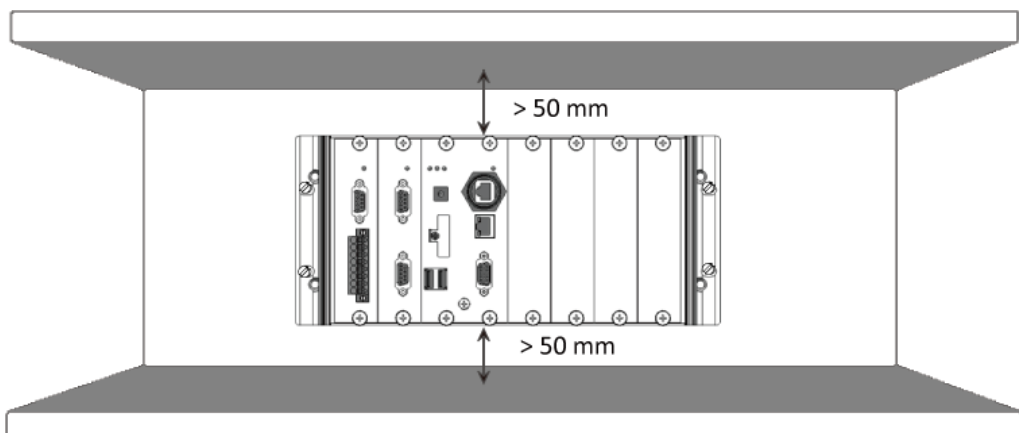

**Step 3: Connect the ground lead to the frame ground point**

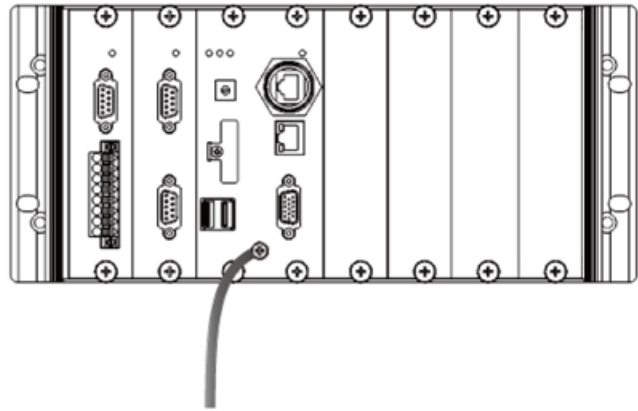

### Tips & Warnings

---



A good common ground reference (earth ground) is essential for proper operation of the WP-9000-CE7. One side of all control circuits, power circuits and the ground lead must be properly connected to earth ground by either installing a ground rod in close proximity to the enclosure or by connecting to the incoming power system ground. There must be a single-point ground (i.e. copper bus bar) for all devices in the enclosure that require an earth ground.

---

### DIN Rail mounting

---

**Step 1: Fasten the DIN rail clip to the WP-9000-CE7**

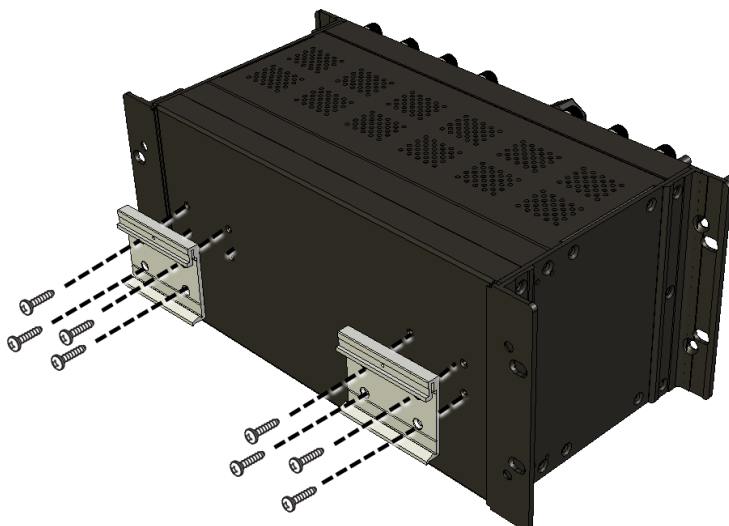

## Step 2: Clip the device onto a stainless DIN rail

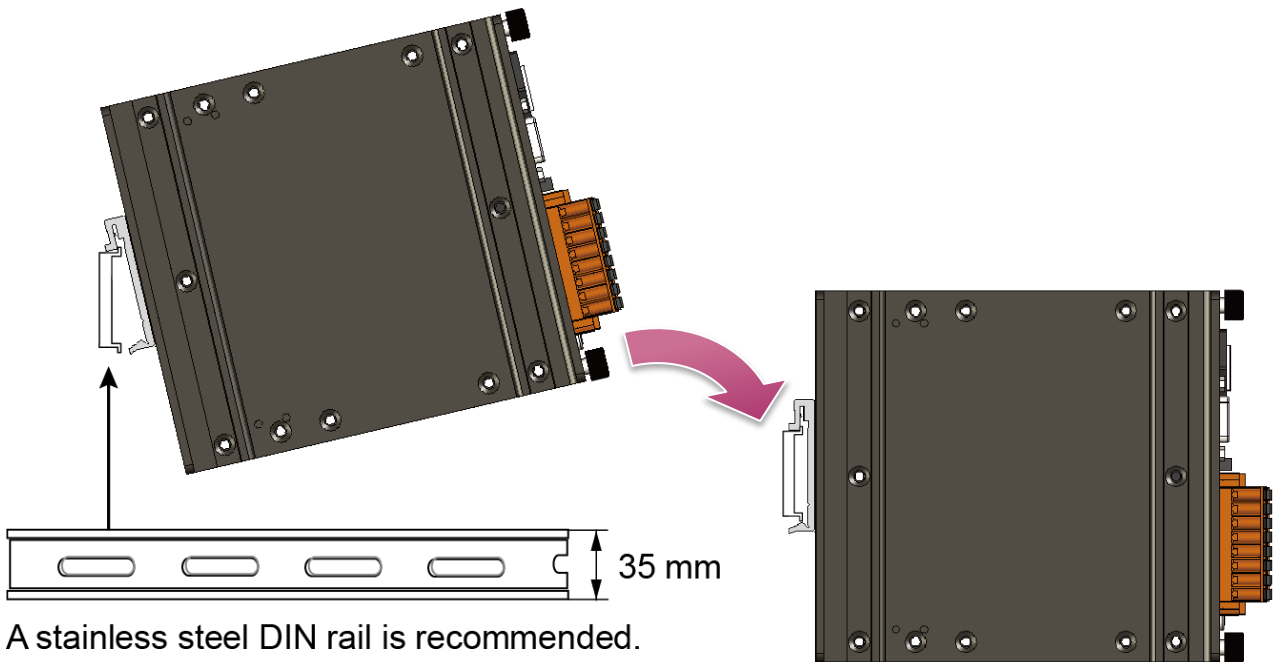

### Tips & Warnings



For DIN rail mounting, it is strongly recommended that only a stainless steel DIN rail be used to support the weight of WP-9000-CE7 system, providing stability and preventing WP-9000-CE7 from leaning

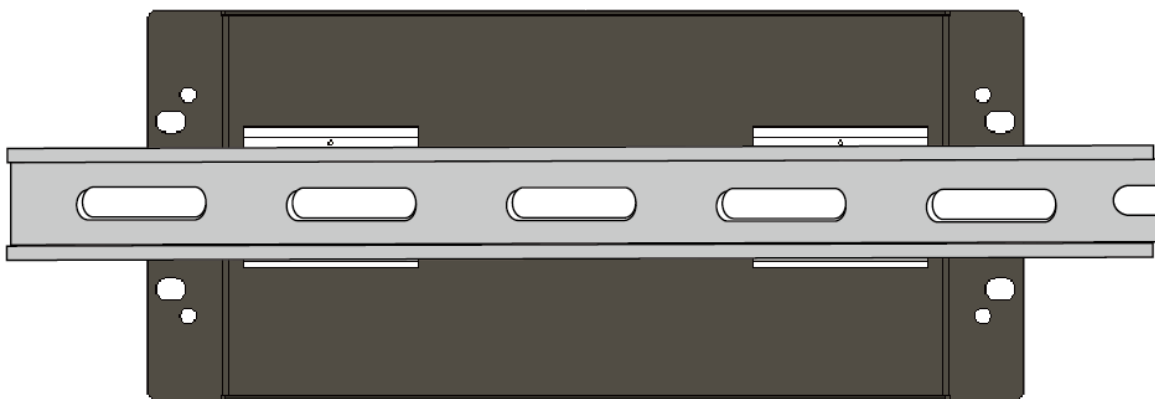

### Step 3: Connect the ground lead to the frame ground point

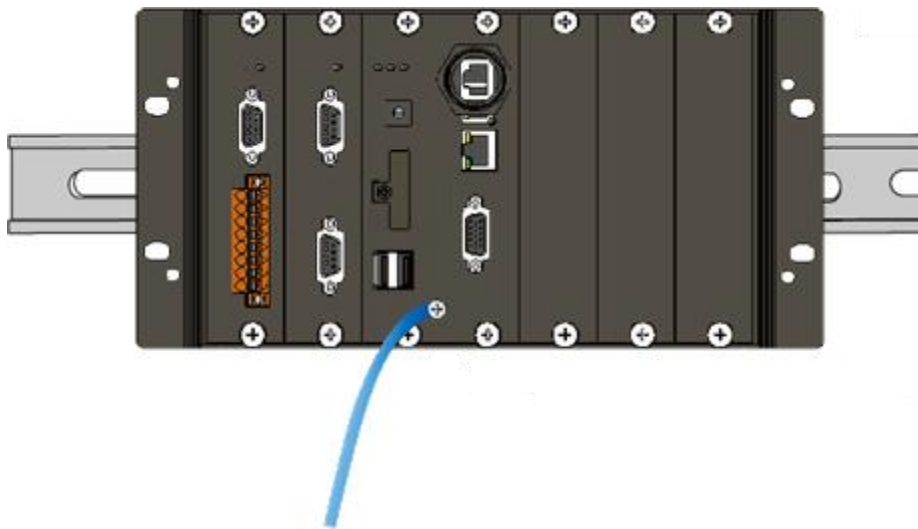

#### Tips & Warnings

---



A good common ground reference (earth ground) is essential for proper operation of the WP-9000-CE7. One side of all control circuits, power circuits and the ground lead must be properly connected to earth ground by either installing a ground rod in close proximity to the enclosure or by connecting to the incoming power system ground. There must be a single-point ground (i.e. copper bus bar) for all devices in the enclosure that require an earth ground.

---



## 2.2. Installing the RJ-45 waterproof connector assembly

The WP-9000-CE7 is equipped with an RJ-45 waterproof connector to withstand contaminant in dusty environment.

### Step 1: Remove the RJ-45 connector from the RJ-45 cable



### Step 2: Feed the end of the RJ-45 cable through the (A) sealing nut, (B) rubber sealing insert, (C) clamping ring, (D) panel gasket and (E) cable gland base

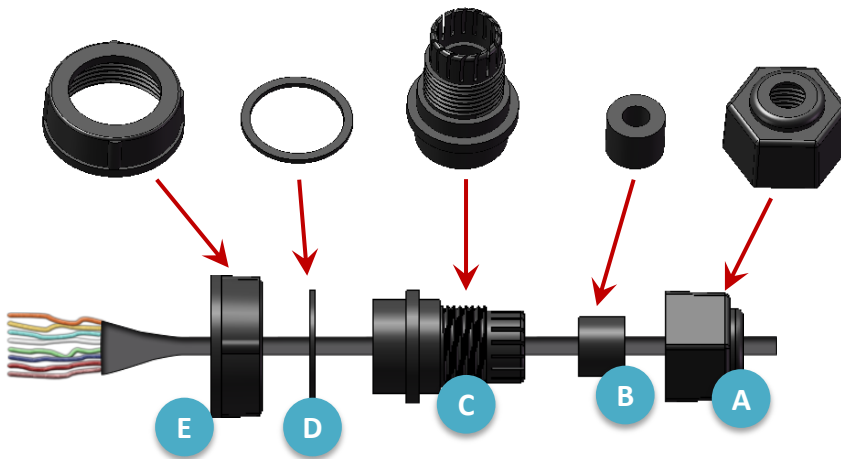

### Step 3: Wrap the (C) clamping ring around the (B) rubber sealing insert

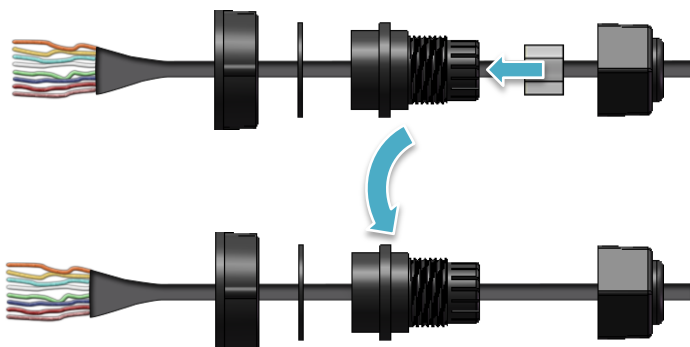

**Step 4: Insert the (D) panel gasket into the (C) clamping ring**

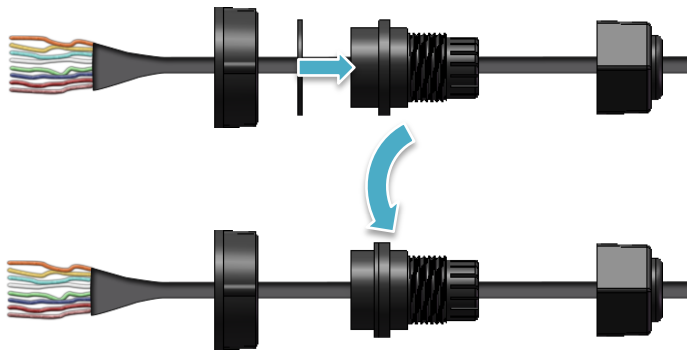

**Step 5: Seat the (C) clamping ring and (D) panel gasket in the (E) cable gland base**

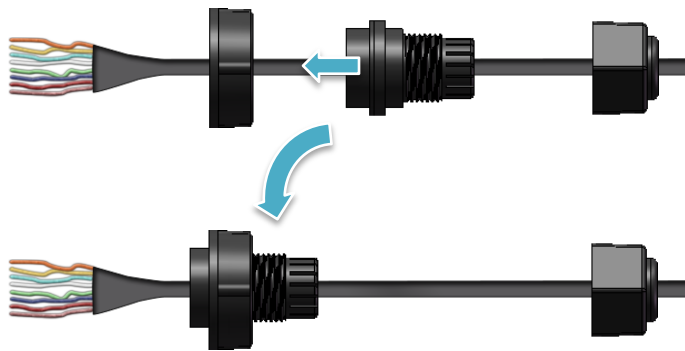

**Step 6: Push the (E) sealing nut forward and Hand-tighten it to seal the assembly**

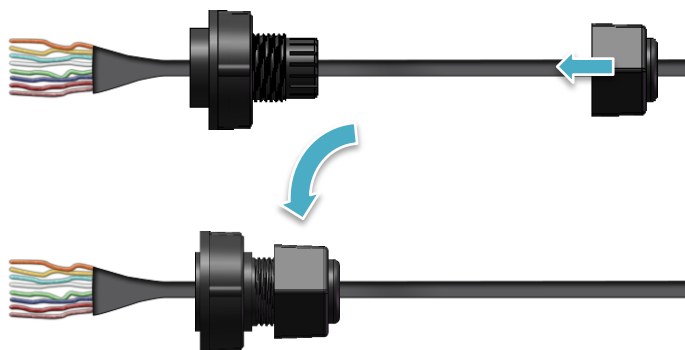

**Step 7: Insert the RJ-45 cable into the RJ-45 connector**

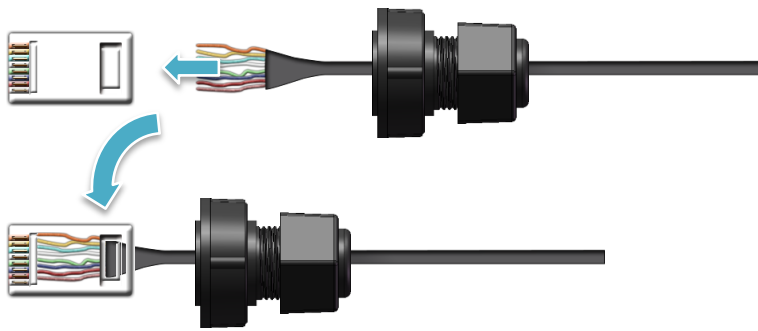

**Step 8: Push the RJ-45 waterproof connector assembly forward**



## 2.3. Deploying a Basic WP-9000-CE7 System

The WP-9000-CE7 provides a variety of communication interface to suit a range of application. Here is a simple application for using the WP-9000-CE7.

**Step 1: Connect the positive terminal (+) of the power supply to the terminal PWR1/2 and the negative terminal (-) of the power supply to the P.GND**

### Tips & Warnings

---



1. The input range of power supply is +10 to +30 V<sub>DC</sub>.
2. The WP-9000-CE7 have two power inputs that can be connected simultaneously to the two independent power sources. If one power source fails, the other source takes over automatically. Redundant power inputs help assure non-stop operation of the WP-9000-CE7.

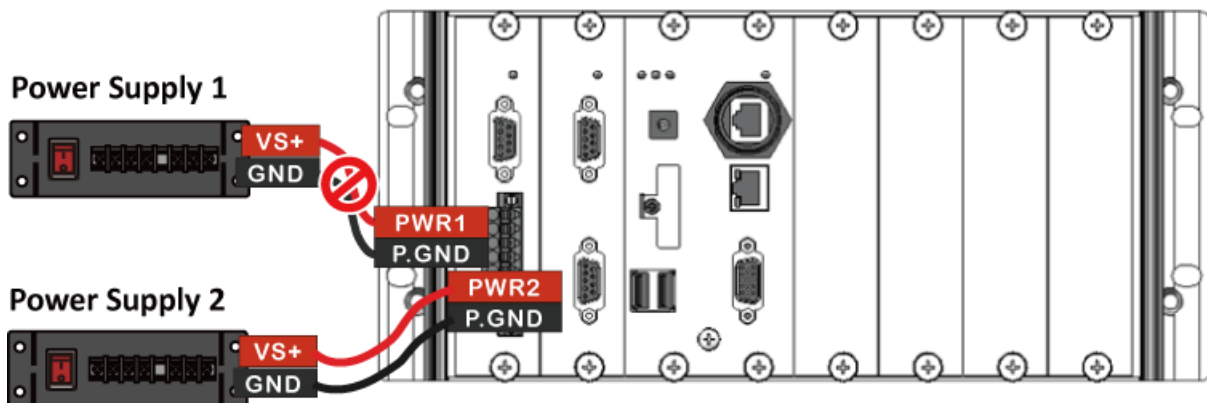

**Step 2: Connect the USB mouse or the USB keyboard to the USB port**

**Step 3: Connect the monitor to the VGA port**

**Step 4: Connect to PC or the laptop to the LAN port via an Ethernet switch**

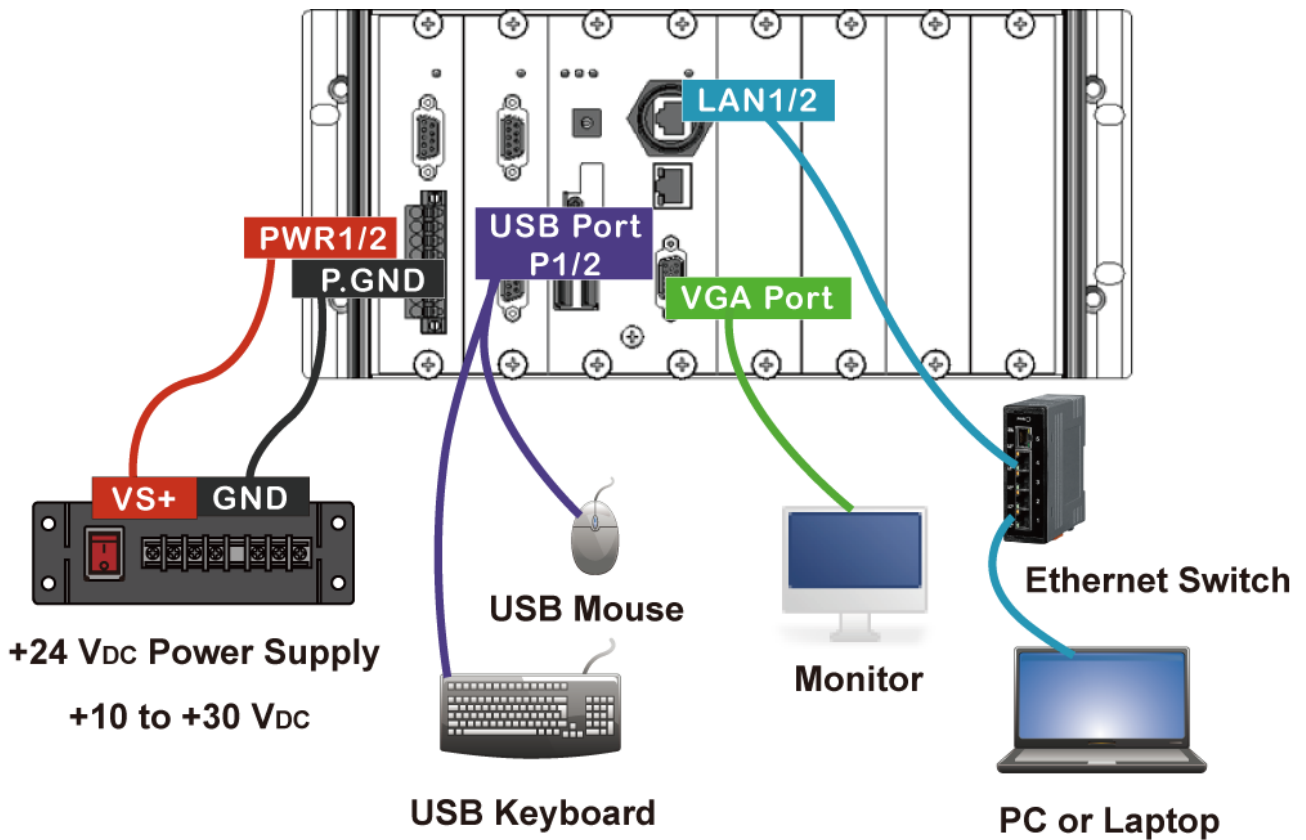

## 2.4. Inserting the I/O Modules

WP-9000-CE7 has 2/4/8 I/O expansion slots and only supports I-9K and I-97K series I/O modules.

Before choosing the right I/O modules, you first need to know the I/O expansion capacities in order to choose the best expansion module for achieving maximal efficiency. For more information about the I/O expansion modules that are compatible with the WP-9000-CE7, please refer to: [http://www.icpdas.com/root/product/solutions/remote\\_io/i-9k\\_i-97k/i-9k\\_i-97k\\_selection.html](http://www.icpdas.com/root/product/solutions/remote_io/i-9k_i-97k/i-9k_i-97k_selection.html)

### Step 1: Insert the I/O module

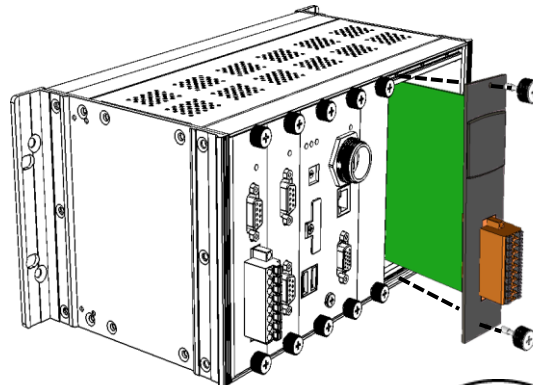

### Step 2: Wiring connection

The metal part of the cord end terminal on the wire can be direct wired to the terminal of XP-9000-CE7.

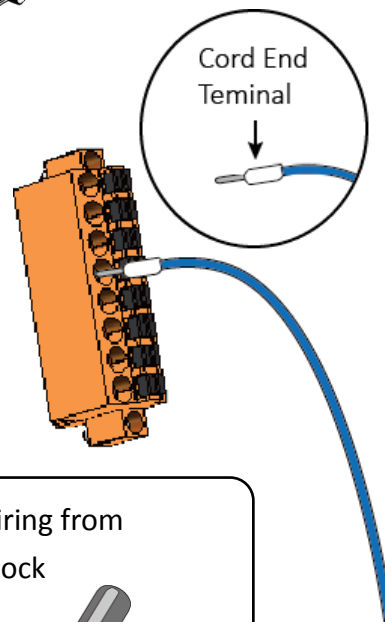

1. Use screwdriver to push the black clip in.

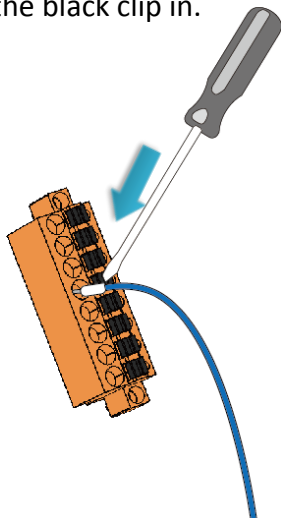

2. Remove the wiring from the terminal block

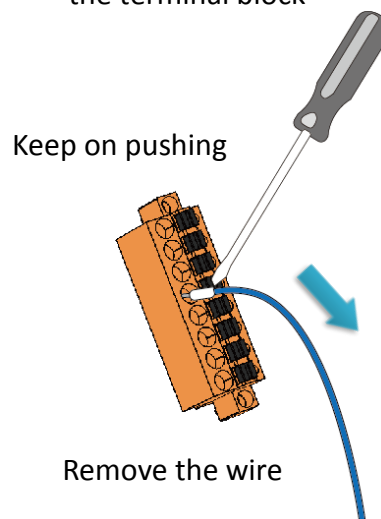

## 2.5. Configuring the Boot Mode

The WP-9000-CE7 has several operating modes, which can be selected by a rotary switch.

The table below lists the operation modes available with the WP-9000-CE7.

Position	Operating Mode
0	Normal mode (Default)
1	Safe mode
2	Debug mode
3	OS update mode by Ethernet
4	Reserve
5	OS update mode by SD
6	Reserve (OS Development Mode)
7 ~ 9	User Mode

The following is a brief introduction of these modes.

### Normal Mode (Default mode)

---

Normal mode is the default mode of operation and the one you will use most of the time. Use this mode for more tasks and configurations. Programs also are executed in this mode.

### Safe Mode

---

Safe mode is a troubleshooting mode. The mode loads the minimum required device drivers and system services to boot the WP-9000-CE7.

If you have malicious software or a program caused the WP-9000-CE7 cannot be boot or run the normal mode, you can boot in safe mode to solve the problem.

## **Debug Mode**

---

Debug mode is a special environment in which program debug functions can be used in addition to normal system functions.

Debug mode is unsupported.

## **OS Update Mode**

---

OS update mode is a way used to update OS. For more information on updating the WP-9000-CE7 OS image, please refer to section 7.1. OS updates

## **Reserve → OS Development Mode**

---

The positions 4, 6, of rotary switch are reserved for OS development.

## **User Mode**

---

The positions 7, 8, 9 of rotary switch are reserved for user's applications.

When WP-9000-CE7 is boot with one of these positions, it is boot at normal mode. User's application can check the position of the rotary switch position to run at different mode.



## 2.6. Changing the User Interface Language

The **Regional and Language Settings** is a Windows CE functionality that allows users to change the WP-9000-CE7 user interface with your native language.

**Step 1: Click Start menu, point to Settings, click Control Panel, and then click Regional Settings**

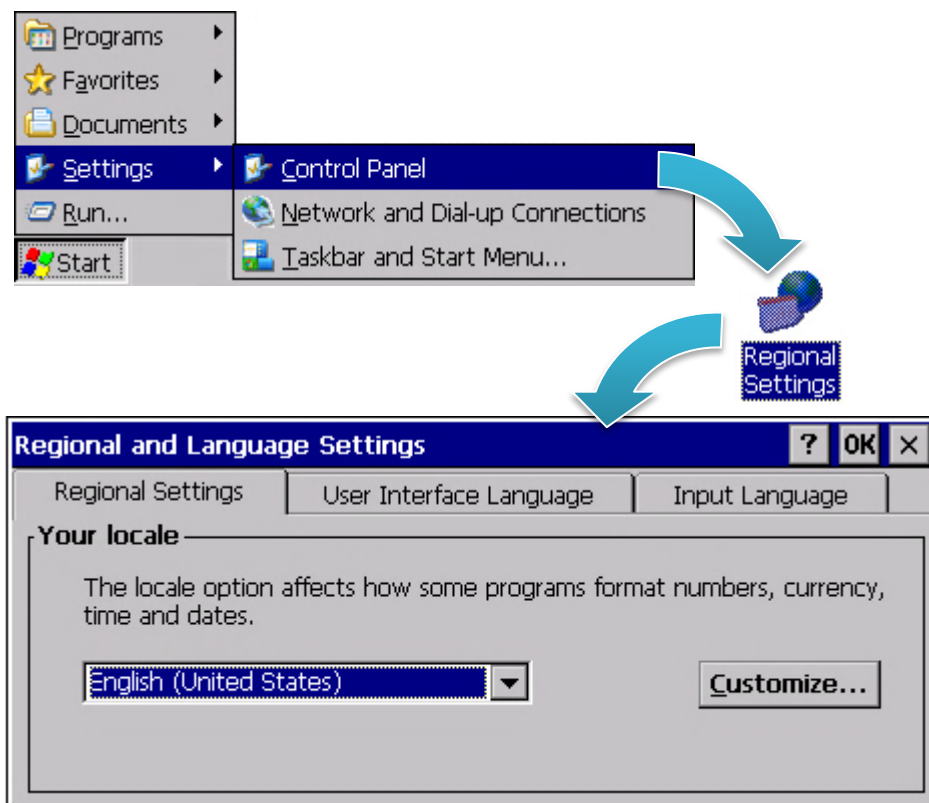

**Step 2: Click User Interface Language tab, choose to your local language, and then click OK button**



**Step 3: Double-click the PAC Utility on the desktop, and then reboot the WP-9000-CE7 for changes to take effect**

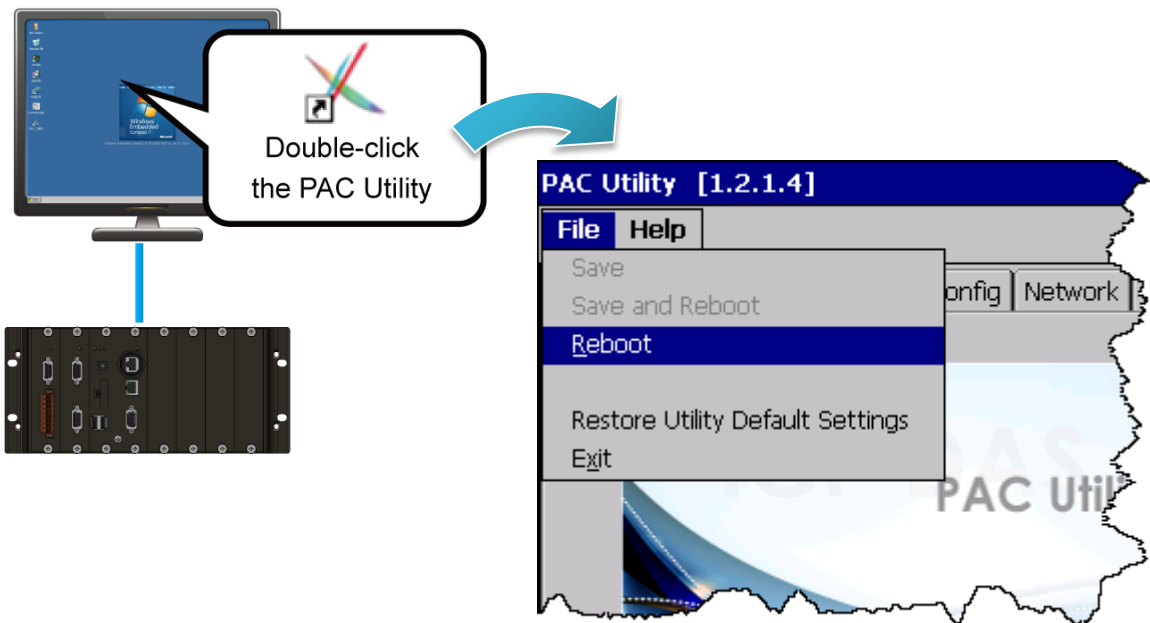

## 2.7. Using PAC Utility to Manage the WP-9000-CE7

The PAC Utility is a collection of the WP-9000-CE7 system tool that allows users to manage and configure the WP-9000-CE7 quickly and easily.

For more detailed information on PAC Utility applications, please refer to “3.1. PAC Utility”

**Step 1: Double-click the PAC Utility on the desktop**

**Step 2: Configure IP address (DHCP), FTP Server, Auto Execution files..., etc.**

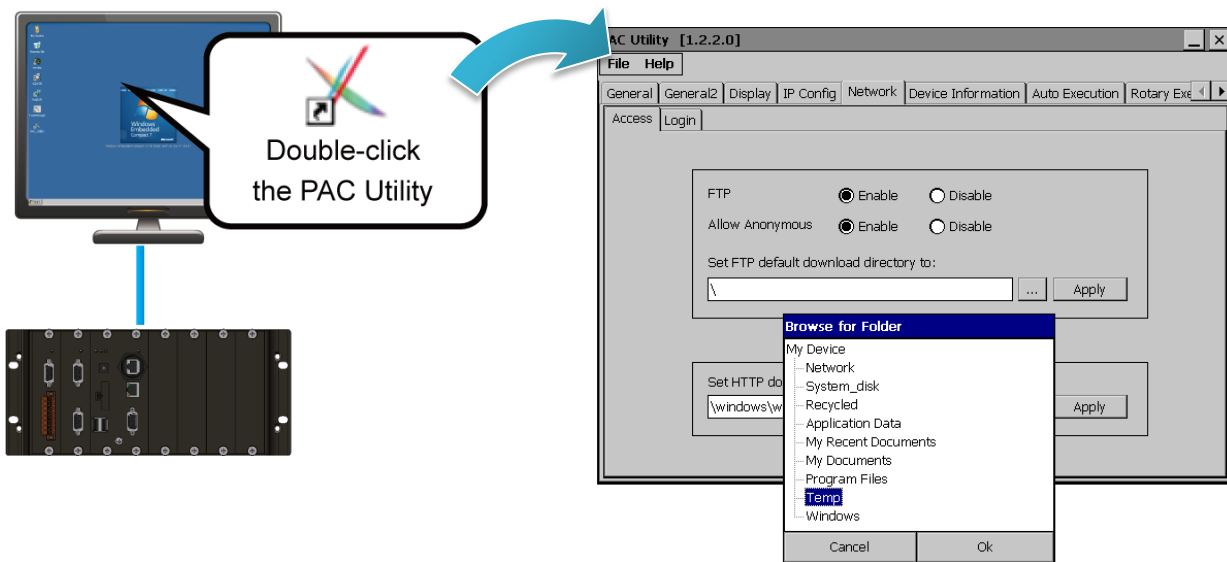

**Step 3: Reboot the WP-9000-CE7 for changes to take effect**

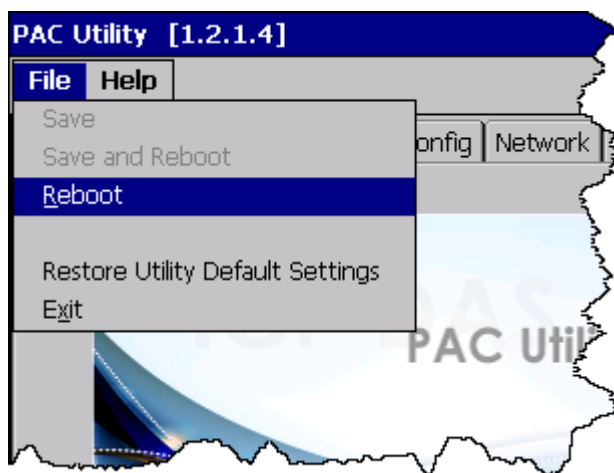

## 2.8. Using DCON Utility Pro Configure I/O Modules

DCON Utility Pro allows users to configure and manage the I/O modules via Ethernet or serial ports (RS-232/RS-485).

**Step 1: Double-click the DCON\_Utility\_Pro on the desktop**

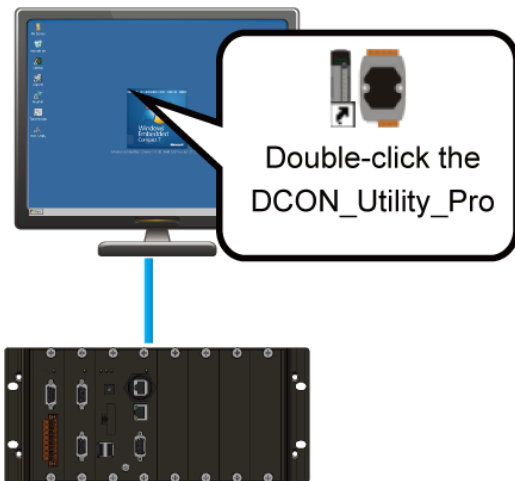

**Step 2: Click the**  **button**

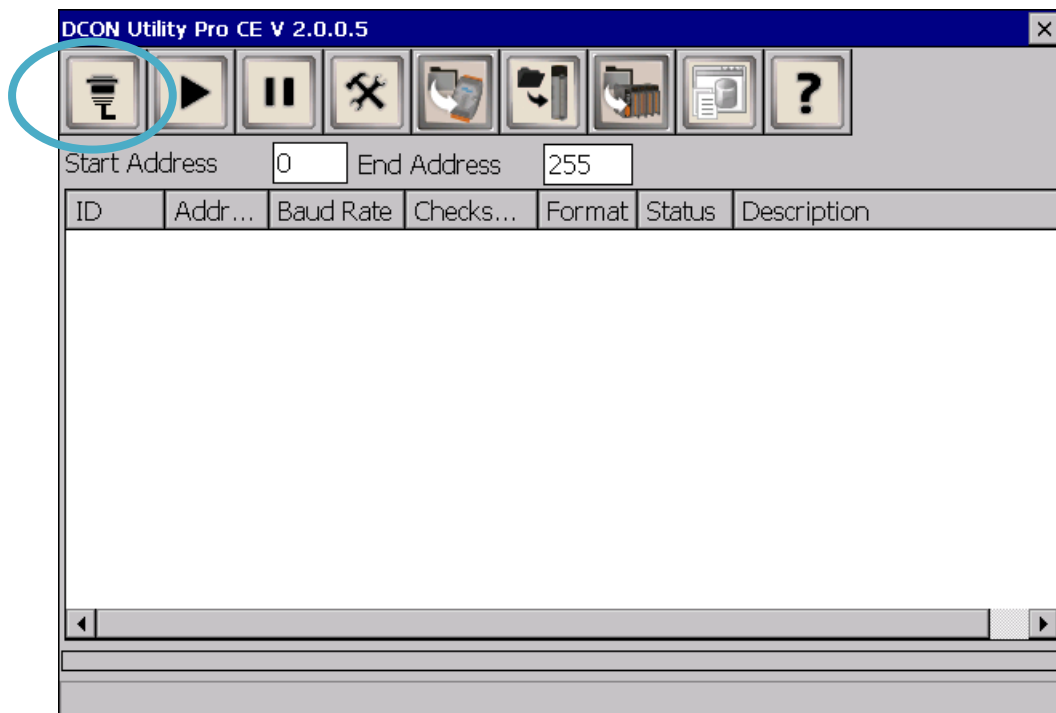

### Step 3: Configure the communication settings

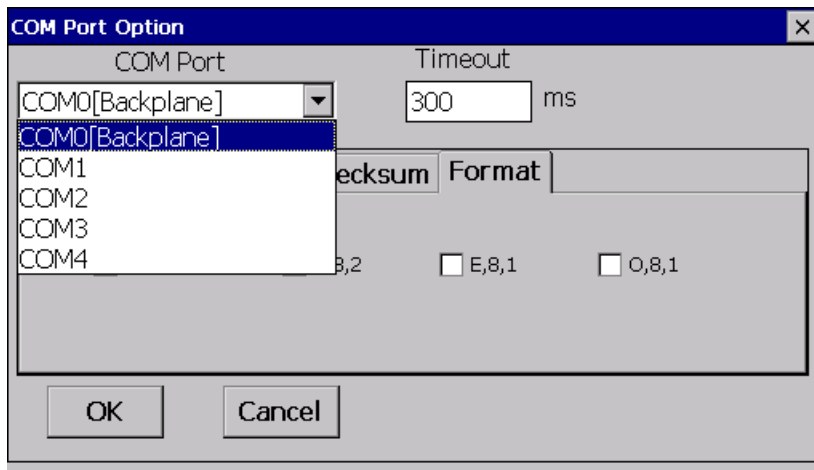

#### Tips & Warnings



The COM port settings for expansion I/O modules are listed below.

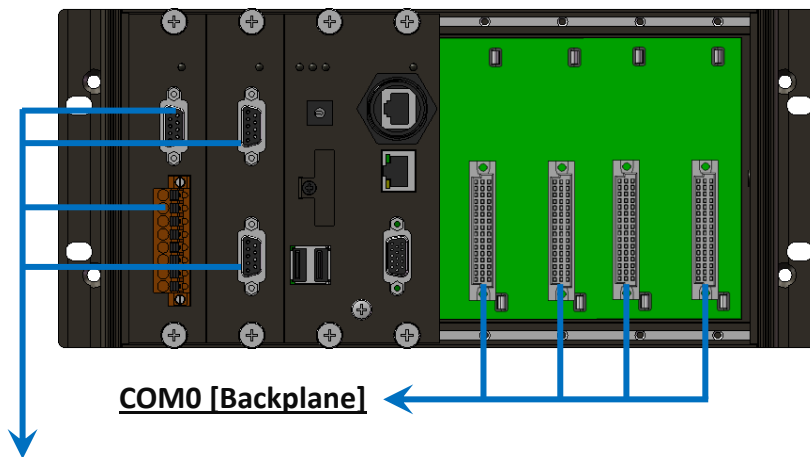

#### COM1/2/3/4

For more information on these COM port selections, please refer to the specification of the pin assignments in section 1.3. Overview

Step 4: Click the  button to scan the I/O module

Step 5: Click the module name to configure the I/O module

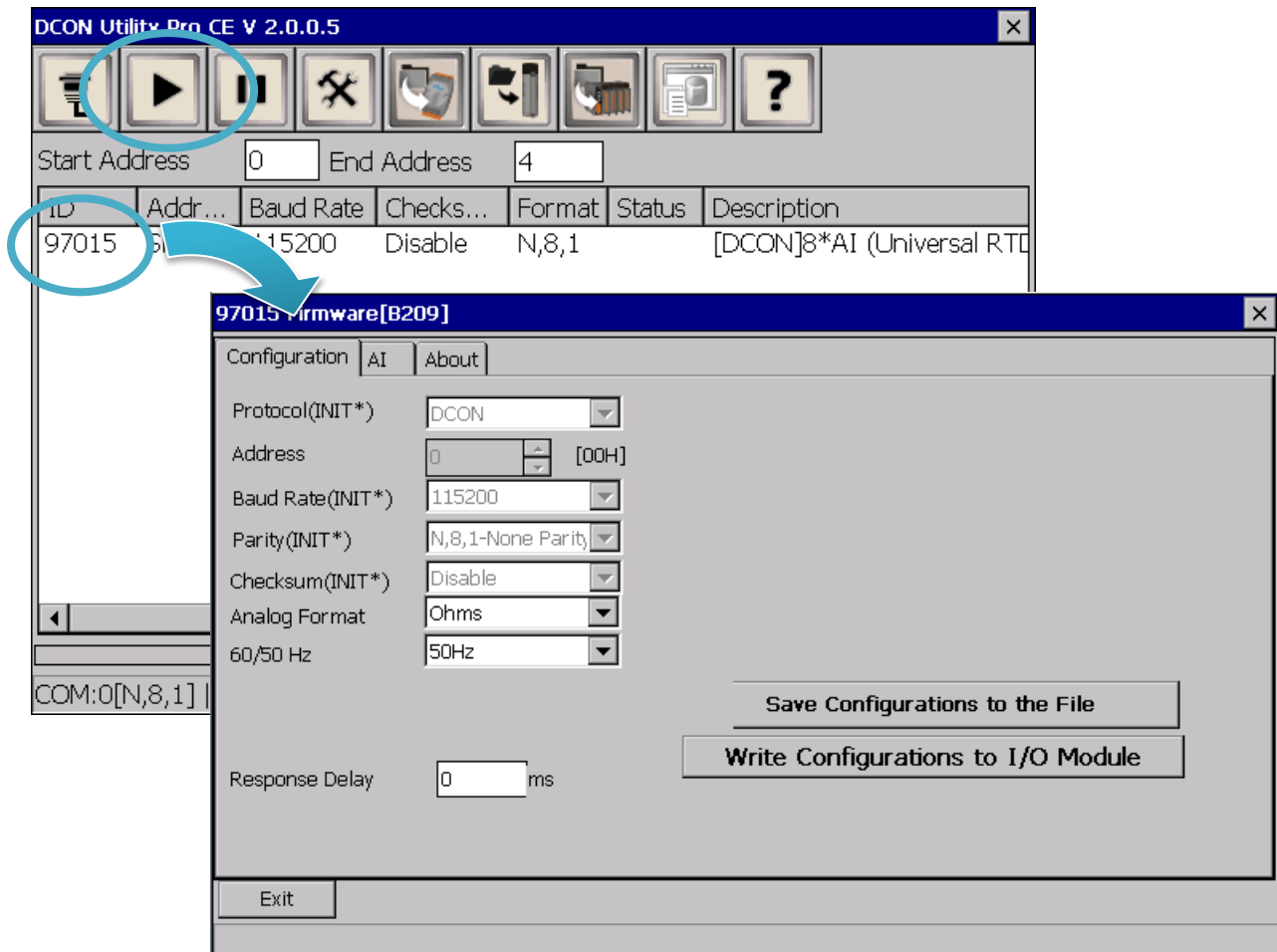

### 3. Tools and Tasks

This chapter provides a brief introduction of the WP-9000-CE7 service tools and its benefits.

There are several tools and utilities built-in and designed for use with WP-9000-CE7. Some of these are pre-installed on WP-9000-CE7 and can work directly on WP-9000-CE7, and some of these are supporting tools and can help you to manage the WP-9000-CE7 remotely on a PC.

The following tools are pre-installed on WP-9000-CE7 and can work directly on WP-9000-CE7 that can be found on the CD that was provided with the package or by downloading the latest version from ICP DAS web site.

CD:\wp-9000\System\_Disk\Tools\

[http://ftp.icpdas.com/pub/cd/winpac\\_am335x/wp-9000/system\\_disk/tools/](http://ftp.icpdas.com/pub/cd/winpac_am335x/wp-9000/system_disk/tools/)

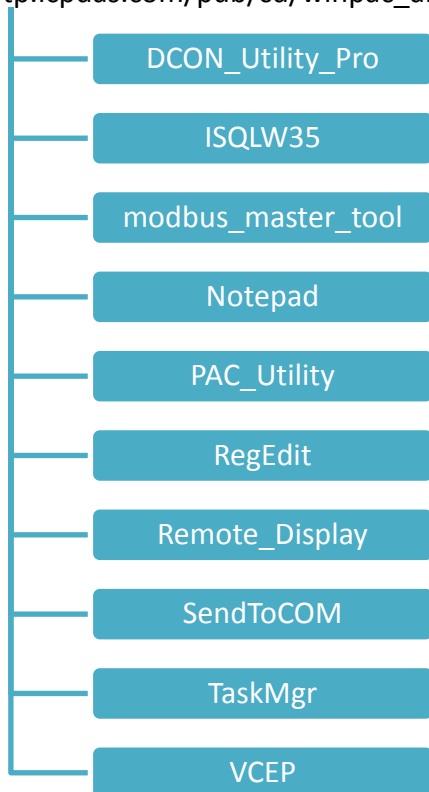

### 3.1. PAC Utility

PAC Utility is a collection of software applications that enable management and configuration of WP-9000-CE7 system and features.

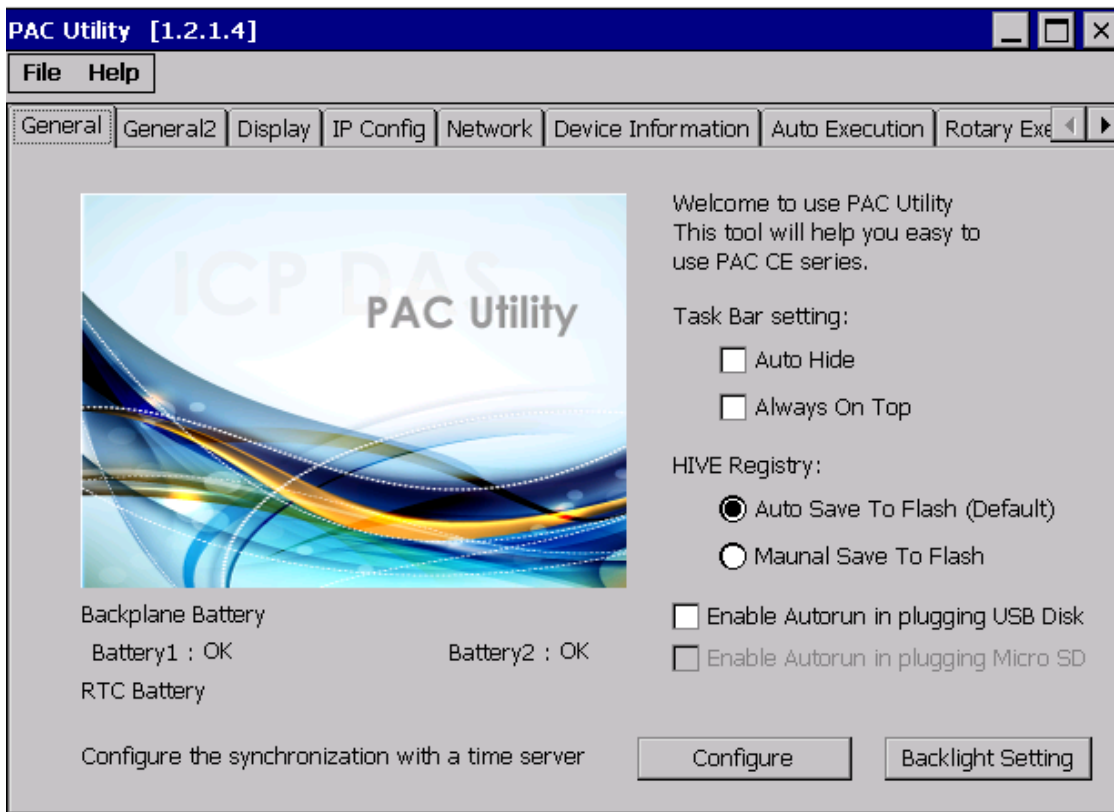

The PAC Utility includes the following menu bars and property tabs. All of these functions will be explained later.

Menu bar	Property Tab
File	General
Help	General2
	Display
	IP Config
	Network
	Device Information
	Auto Execution
	Rotary Execution



### 3.1.1. Menu Bar – File

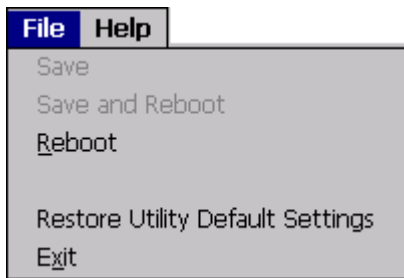

The menus use to	How to use
Reboot	Restarts the WP-9000-CE7
Restore Utility Default Settings	Restore the WP-9000-CE7 to default settings.
Exit	Exits the PAC Utility.

### 3.1.2. Menu Bar – Help

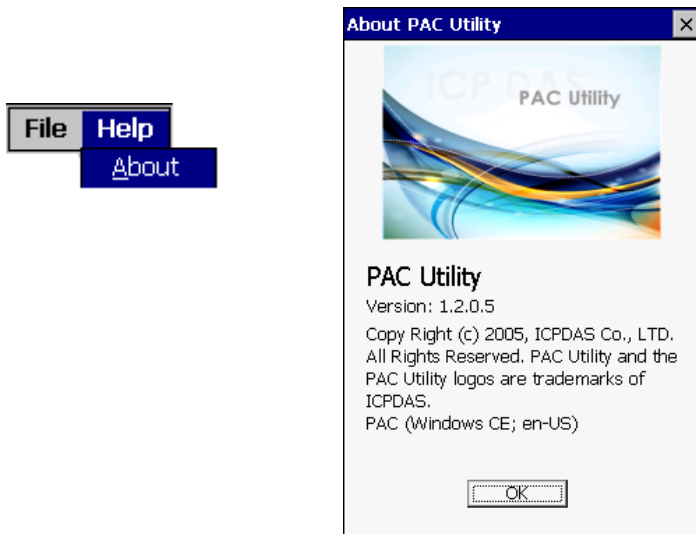

The menus use to	How to use
About	Displays a dialog box with information about PAC Utility, including the current version and copyright information.

### 3.1.3. Property Tab - General

The **General** tab provides functions to configure the task bar, check the status of the battery..., etc.

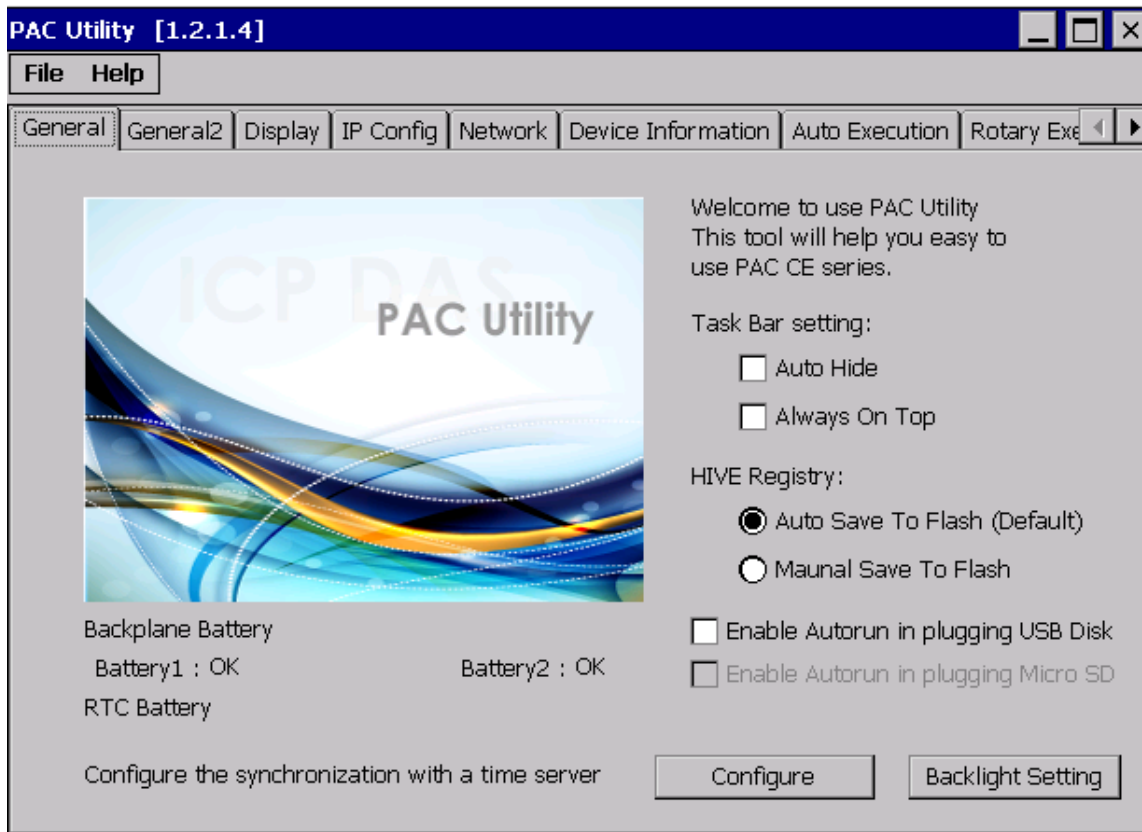

The tab use to	How to use
Lock or Auto-Hide the taskbar	<p><b>Auto-Hide the taskbar:</b> Select the <b>Auto Hide</b> check box.</p> <p><b>Lock the taskbar:</b> Select the <b>Always On Top</b> check box.</p>
Auto save or manual save to flash	<p><b>Auto save to flash:</b> Select the <b>Auto Save To Flash (Default)</b> check box. Any changes made to the WP-9000-CE7 will be saved and only take effect after the WP-9000-CE7 reboots.</p> <p><b>Manual save to flash:</b> Select the <b>Manual Save to Flash</b> check box. Any changes made to the WP-9000-CE7 will be saved by clicking the Save and Reboot from File menu.</p>

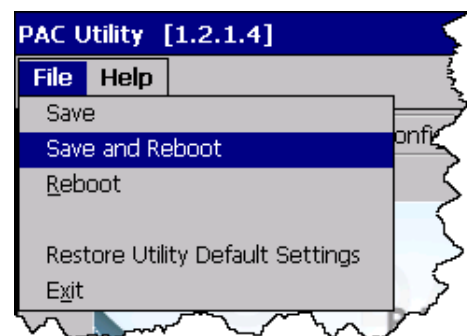

The tab use to	How to use
Enable USB autorun	Select the <b>Enable Autorun in plugging USB Disk</b> check box.
Enable SD auotrun	This item is temporarily unavailable.
Automatic synchronization of system time	Refer to the Appendix A.2. How to configure the service for automatically synchronizing with the internet time server.

### 3.1.4. Property Tab – General2

The **General2** tab provides functions to specify the name of the USB disk.



The tab use to	How to use
Specify the name of the USB disk	Enter a name in the <b>USB Hard Disk:</b> field

### 3.1.5. Property Tab – Display

The **Display** tab provides functions to configure the monitor settings.

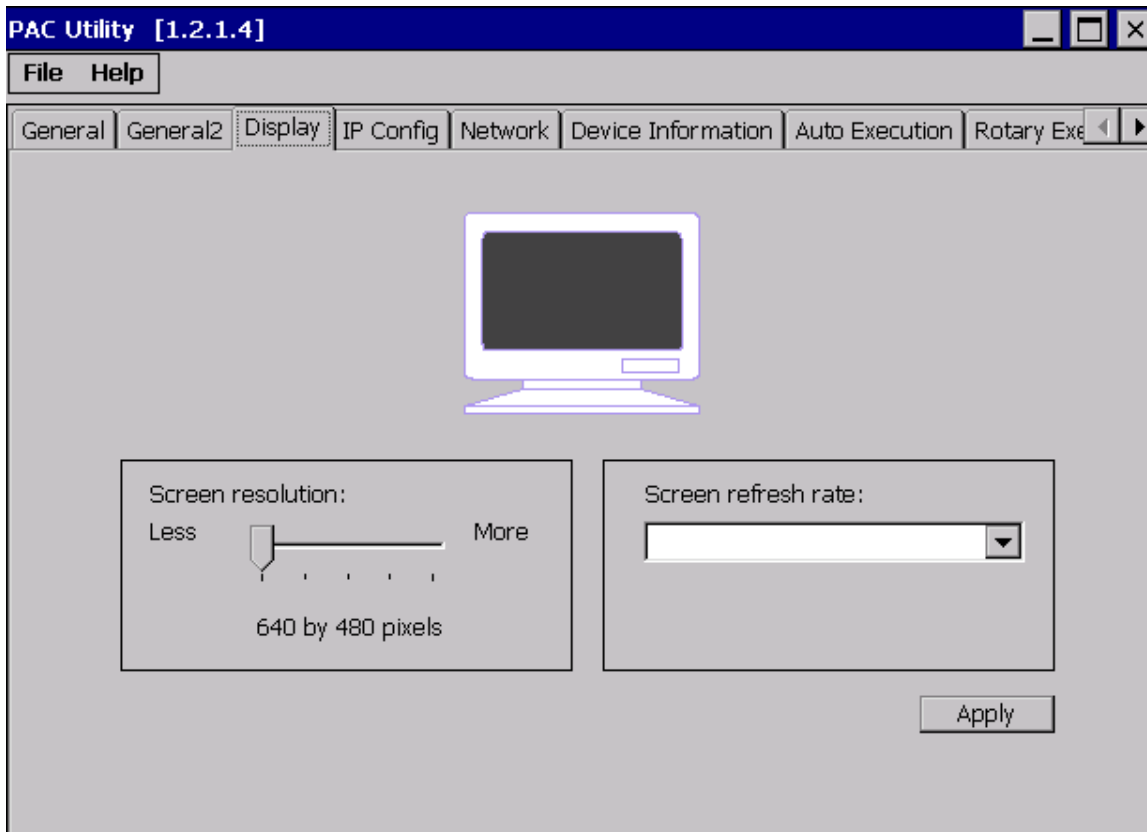

The tab use to	How to use
Adjust the screen resolution	Move the slider to the left to decrease the resolution or move the slider to the right to increase the resolution, and then click the <b>Apply</b> button.
Change the screen refresh rate	Select the desired refresh rate from the <b>Screen refresh rate</b> drop-down list, and then click the <b>Apply</b> button.

### 3.1.6. Property Tab – IP Config

The **IP Config** tab provides functions to configure either DHCP (Roaming) or manually configured (Static) network settings and to monitor the MAC address. Generally, DHCP is the default settings, but if you don't have a DHCP server, you must configure the network settings by using manual configuration.

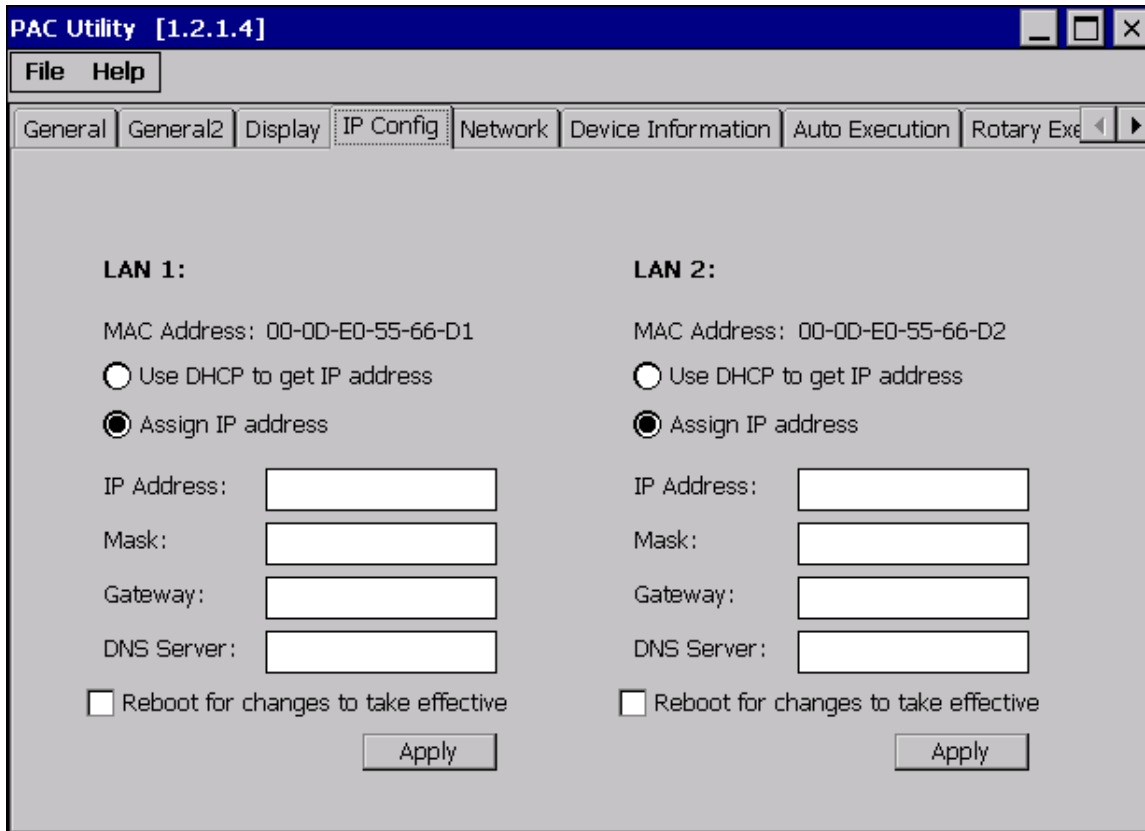

The tab use to	How to use
Set the network settings	<p><b>Use DHCP to get IP address:</b> Select the <b>Use DHCP to get IP address</b> option, and then click the <b>Apply</b> button.</p> <p><b>Assign an IP address:</b> Select the <b>Assign IP address</b> option, and then click the <b>Apply</b> button.</p>

### 3.1.7. Property Tab – Network

The **Network** tab comprises three tabs – Access, Login and File Server Settings.

#### Access

The **Access** tab provides functions to enable/disable the FTP access, enable/disable anonymous FTP access, and configure the FTP and HTTP directory path.

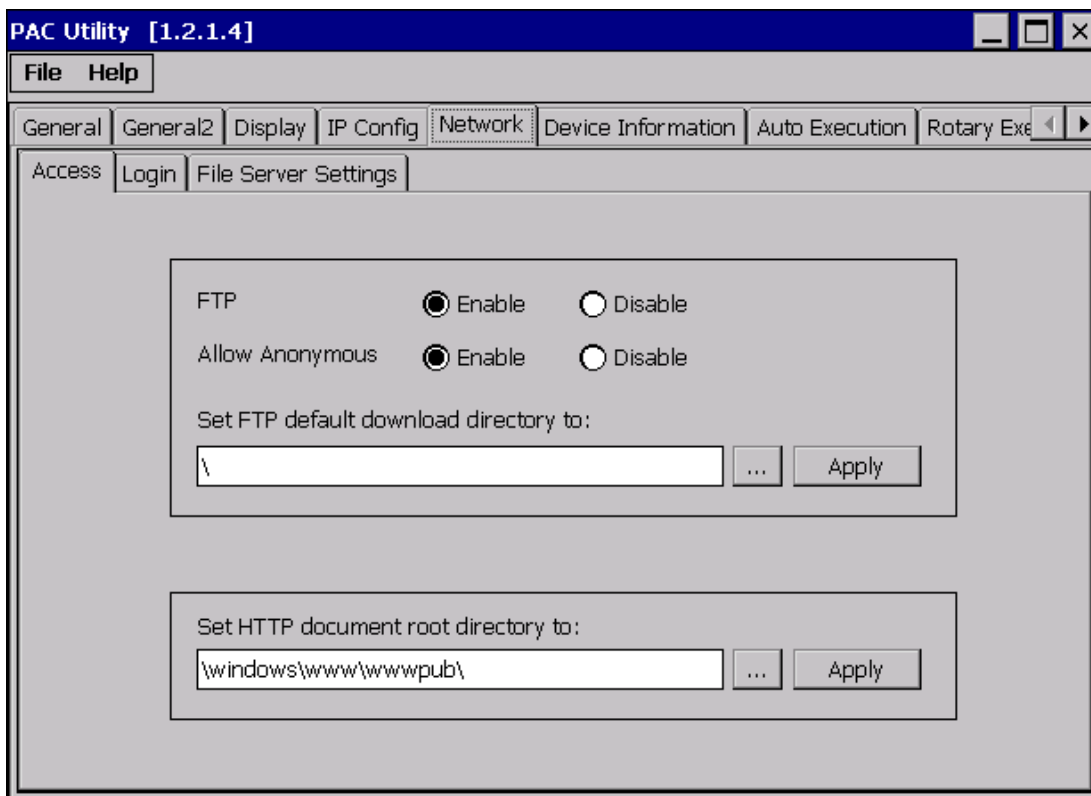

The tab use to	How to use
Enable or disable the FTP access	<p><b>Enable the FTP access:</b> Select the <b>Enable</b> check box in the <b>FTP</b> field, and then click the <b>Apply</b> button.</p> <p><b>Disable the FTP access:</b> Select the <b>Disable</b> check box in the <b>FTP</b> field, and then click the <b>Apply</b> button.</p>



The tab use to	How to use
Enable or disable anonymous FTP access	<p><b>Enable anonymous FTP access:</b> Select the <b>Enable</b> check box in the <b>Allow Anonymous</b> field, and then click the <b>Apply</b> button.</p> <p><b>Disable anonymous FTP access:</b> Select the <b>Disable</b> check box in the <b>Allow Anonymous</b> field, and then click the <b>Apply</b> button.</p>
Set the FTP directory path	Enter a new path in the <b>Set FTP default download directory to:</b> field, and then click the <b>Apply</b> button.
Set the HTTP directory path	Enter a new path in the <b>Set HTTP document root directory to:</b> field, and then click the <b>Apply</b> button.

## Login

The **Login** tab provides functions to maintain the FTP accounts.

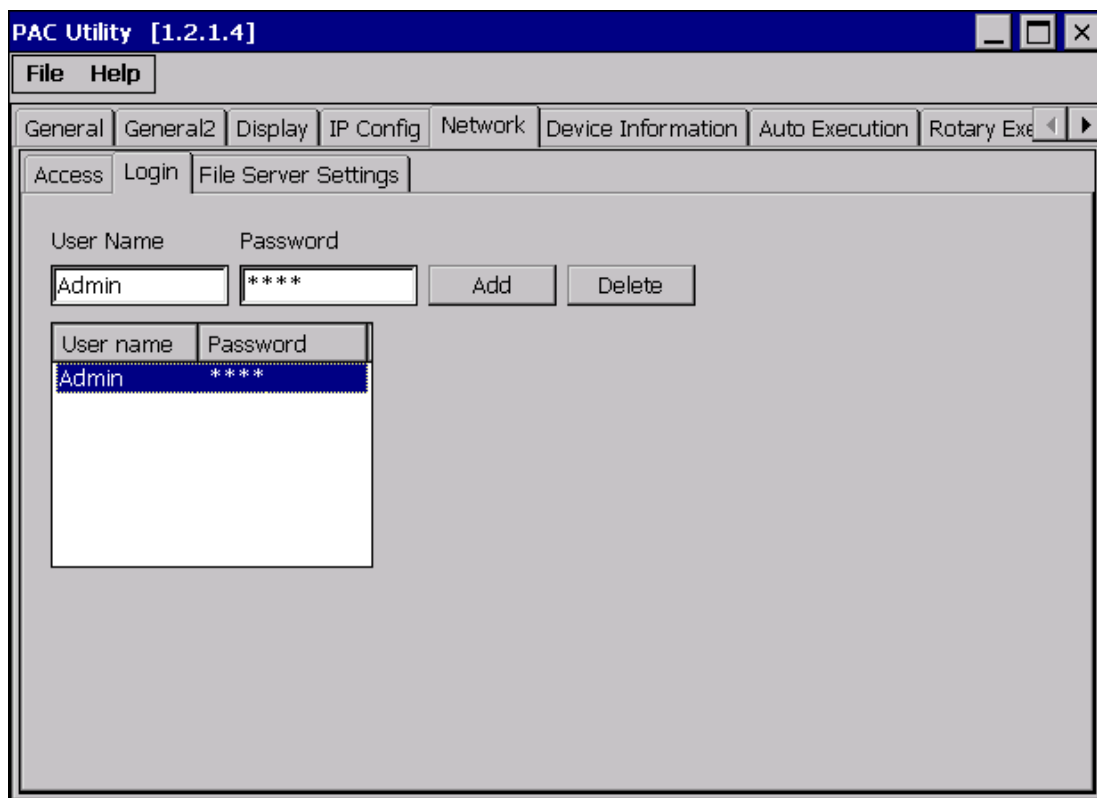

The tab use to	How to use
Maintain the FTP accounts	Refer to the Appendix C.1 How to add a user account to remote login the WP-9000-CE7 from PC.

## File Server Settings

The **File Server Settings** tab provides functions to set the SMB server.

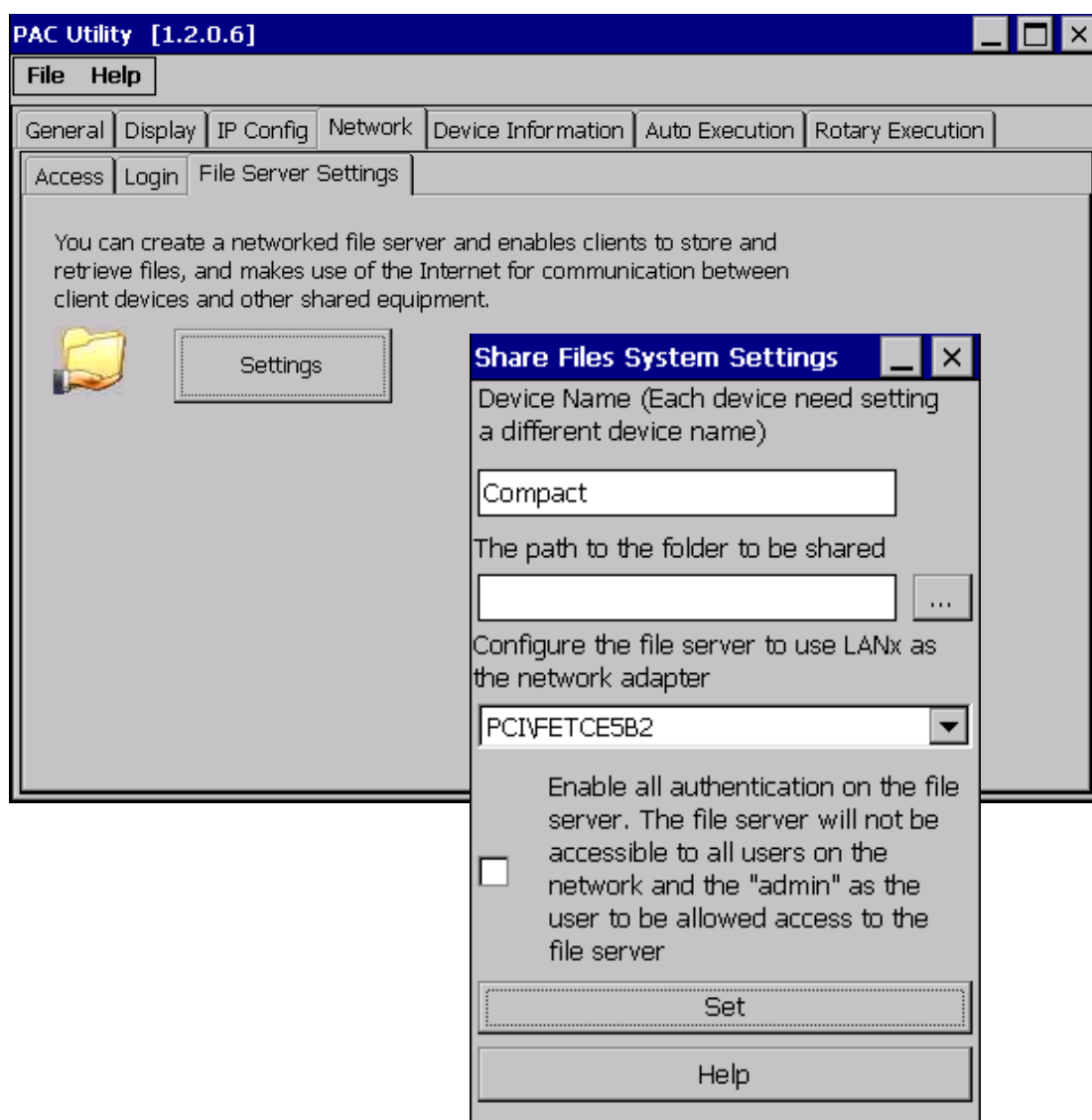

The tab use to	How to use
Set the SMB server	Click the Settings button to set the SMB server path.

### 3.1.8. Property Tab – Device Information

The **Device Information** tab provides functions to monitor necessary system information of the WP-9000-CE7. The information is the most important note of version control for upgrading system.

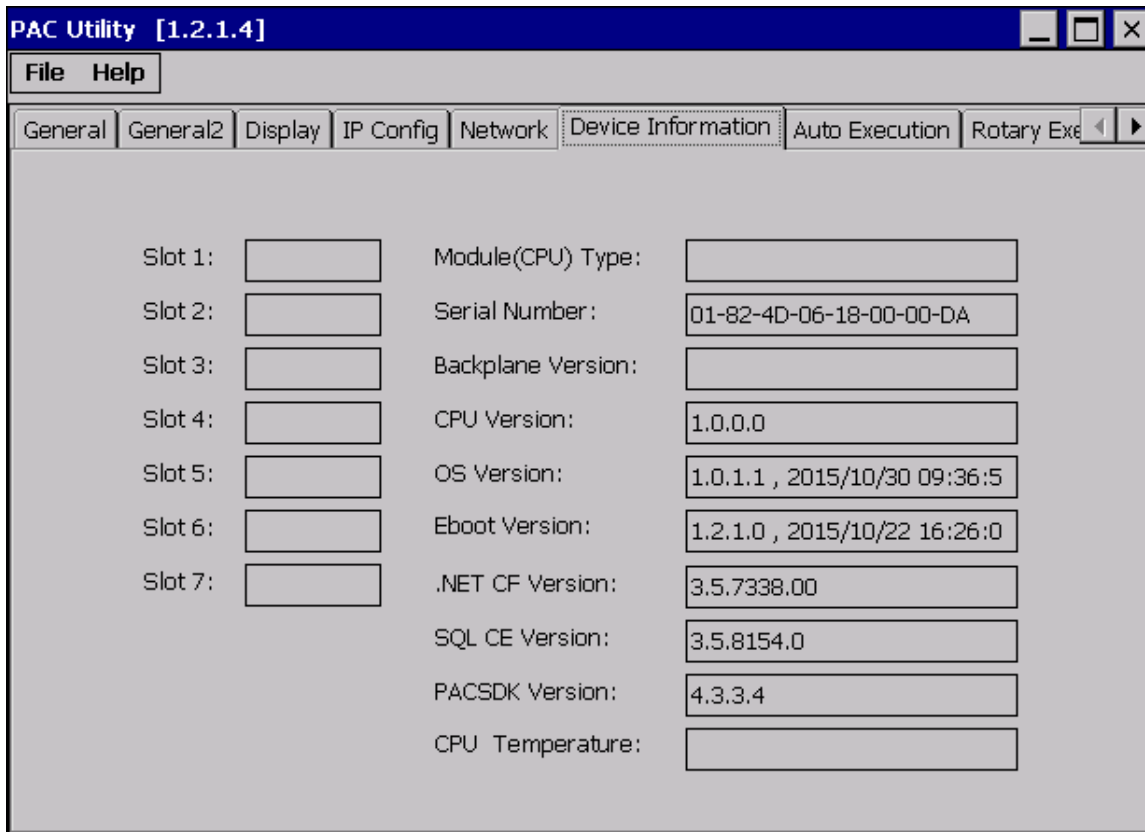

### 3.1.9. Property Tab – Auto Execution

The **Auto Execution** tab provides functions to configure programs running at WP-9000-CE7 startup, it allows users to configure ten execute files at most.

#### Tips & Warnings



The specific extensions are .exe and .bat, and they are executed in order of program 1, program 2, etc.

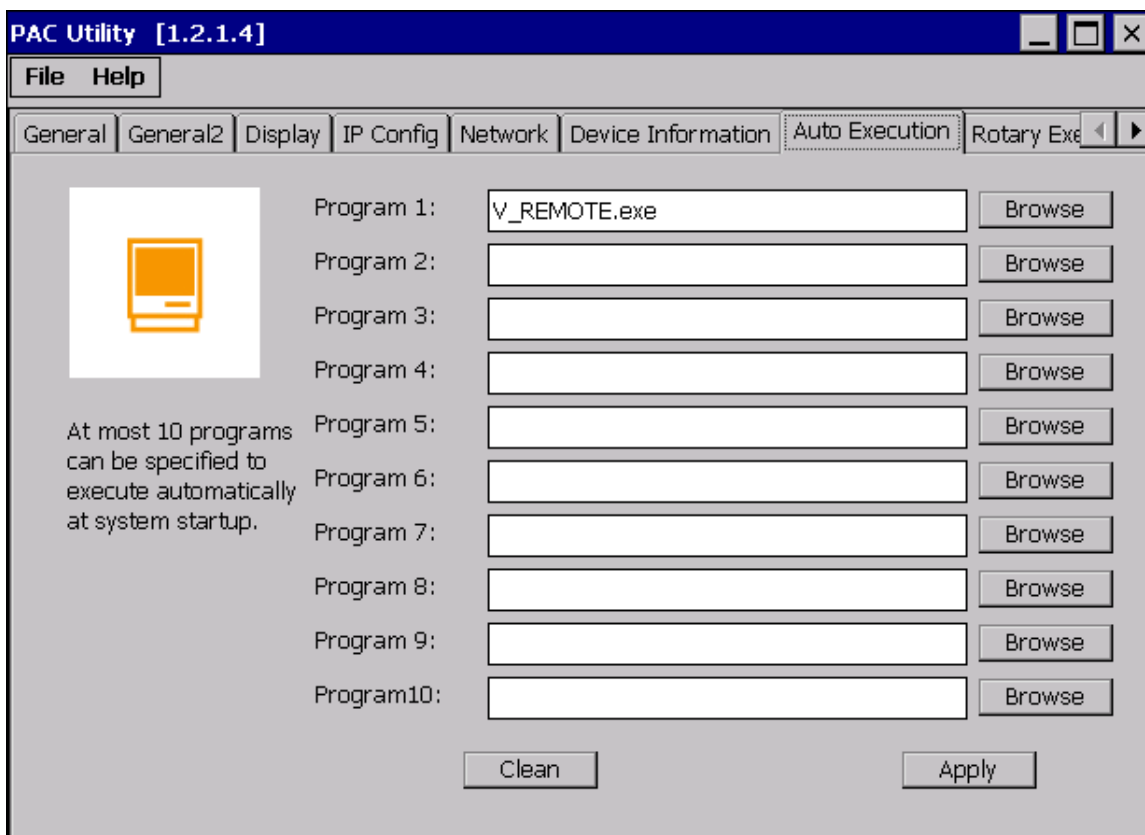

The tab use to	How to use
Configure programs running at startup	Click the <b>Browse</b> button to select the execute file which you want, and then click the <b>Apply</b> button.

### 3.1.10. Property Tab – Rotary Execution

The **Rotary Execution** tab provides functions to configure programs running at WP-9000-CE7 startup in one of the user defined mode, it allows users to configure ten execute files at most.

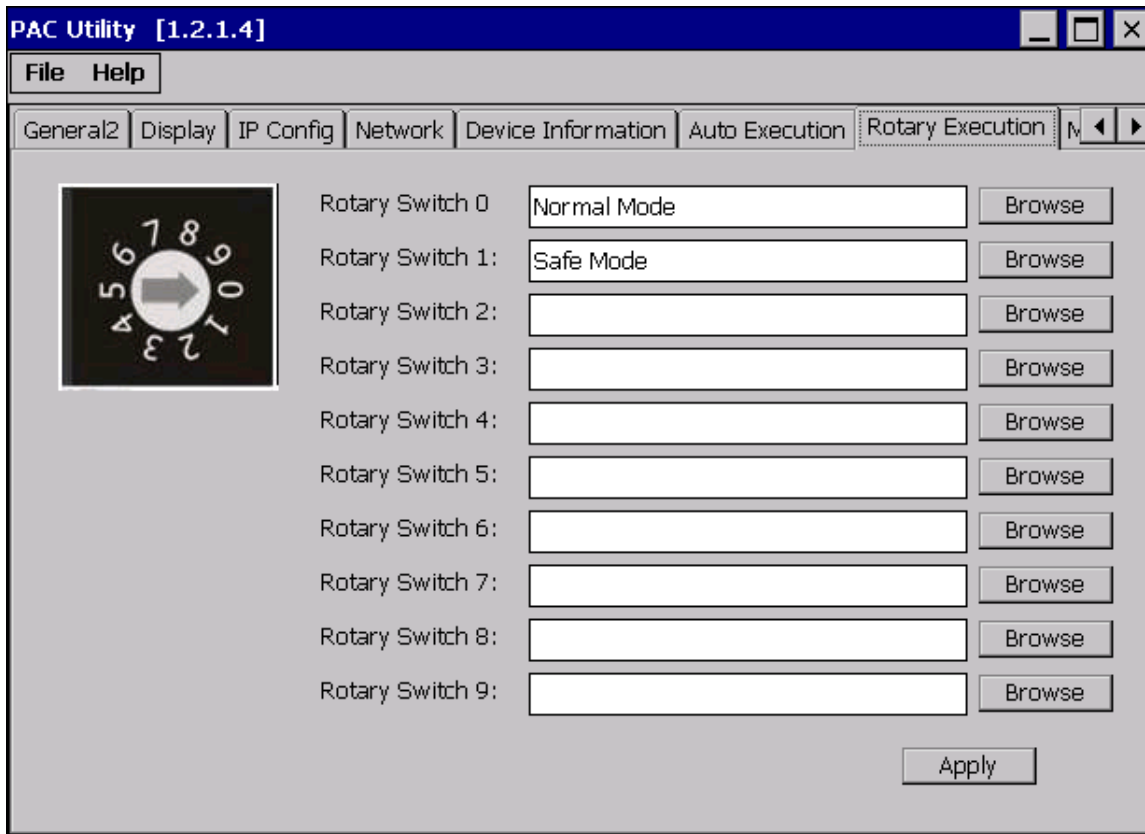

The tab use to	How to use
Configure programs running at startup in one of the user defined mode	Click the <b>Browse</b> button to select the execute file which you want, and then click the <b>Apply</b> button.

## 3.2. DCON Utility Pro

DCON Utility Pro enables users easily to configure and manage the I/O modules via Ethernet or serial ports (RS-232/RS-485).

For more information on how to use DCON Utility Pro to configure I/O modules, please refer to 2.7. Using DCON Utility Pro to Configure I/O Modules

For more detailed information on DCON Utility application, please refer to:

[http://www.icpdas.com/root/product/solutions/software/utilities/dcon\\_utility\\_pro.html](http://www.icpdas.com/root/product/solutions/software/utilities/dcon_utility_pro.html)

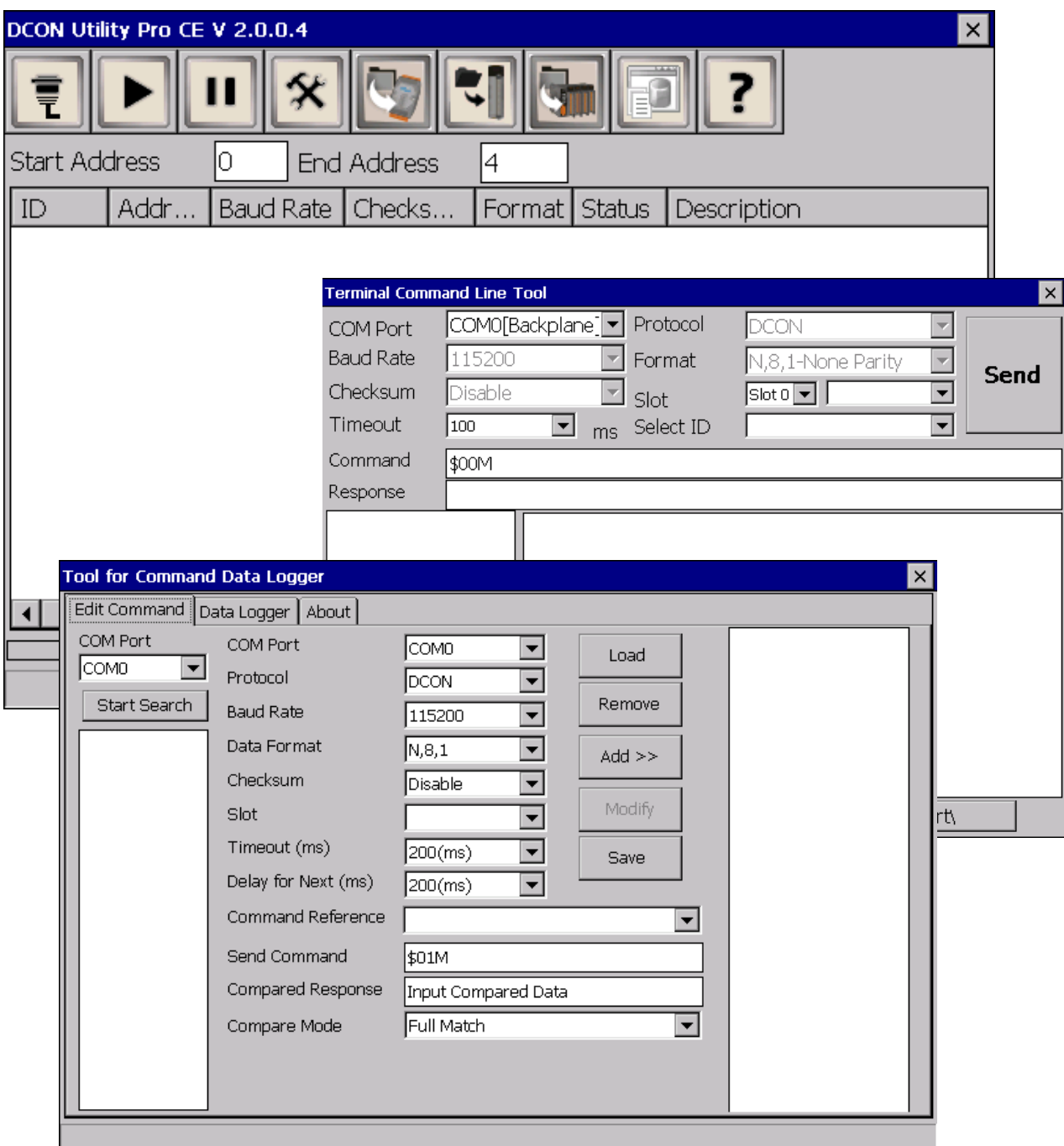

### 3.3. TaskMgr

The TaskMgr is a Windows CE application, which provides real time info on all processes and threads including System threads, similar in appearance to the Windows Task Manager.

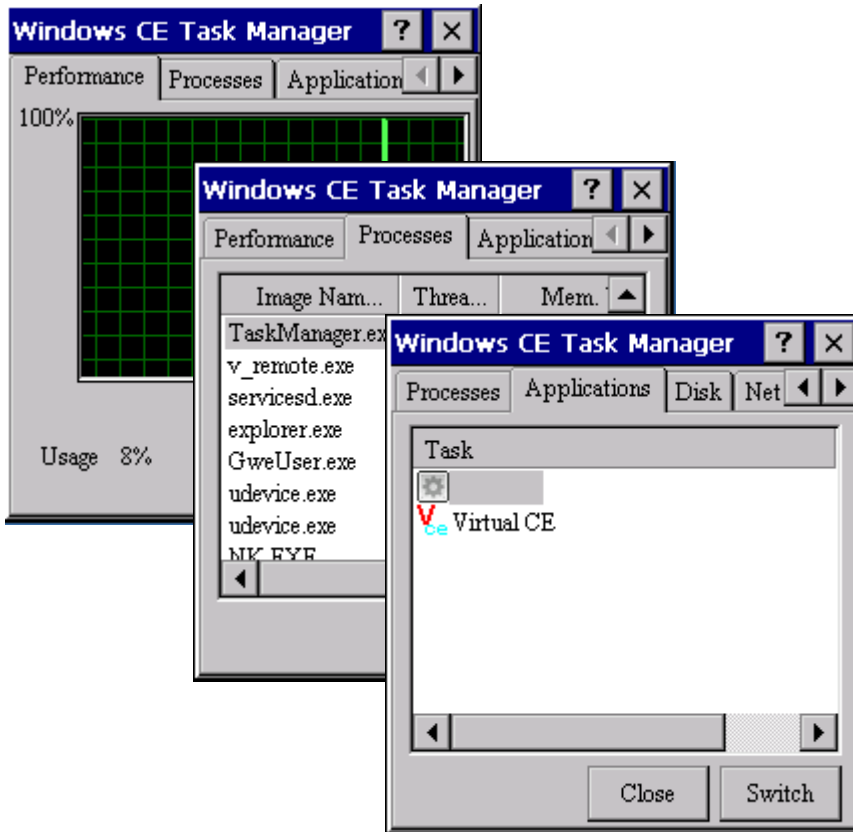

### 3.4. VCEP

ICP DAS VCEP is designed for managing your WP-9000-CE7 anywhere. No matter where you are, ICP DAS VCEP provides a convenient environment on the Desktop PC and lets you control your WP-9000-CE7 remotely.

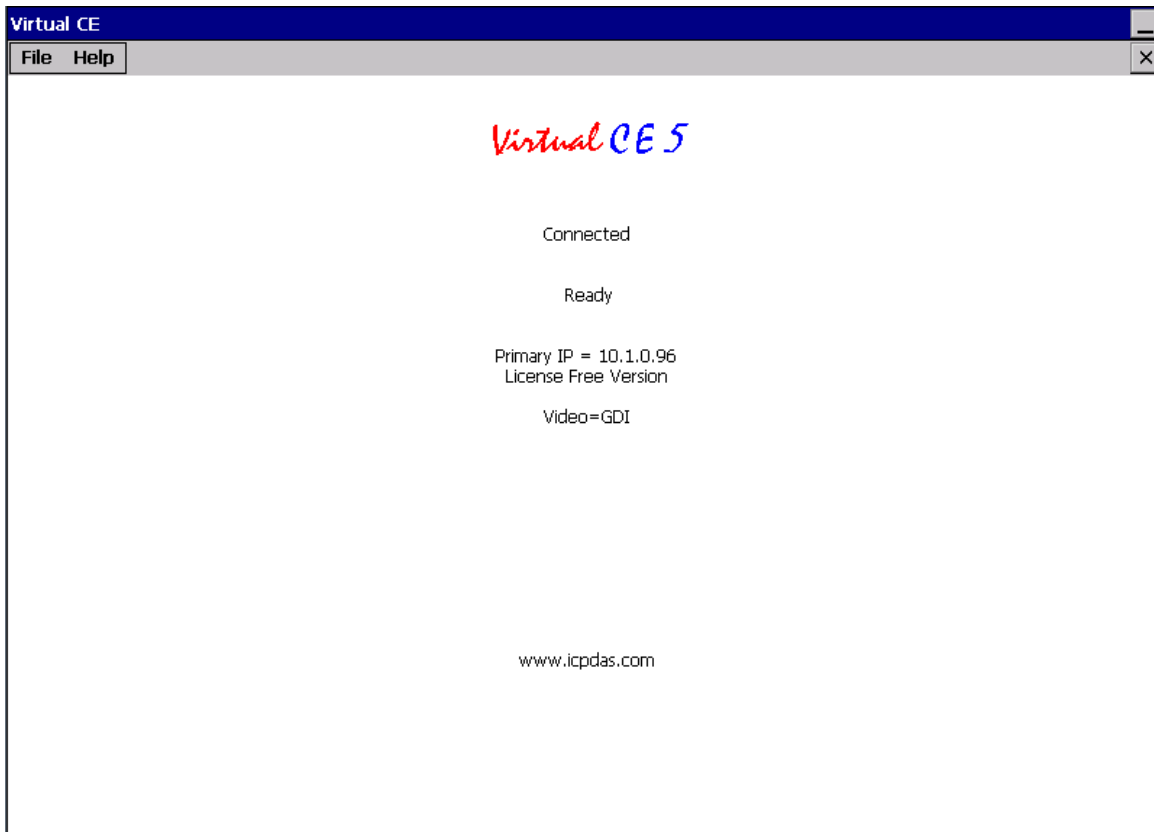

ICP DAS VCEP is composed of two main components: The **Server** which runs on WP-9000-CE7 and the **Client** which runs on a Desktop PC.

Once a connection is established between the client and server (initiated by the client), the client will periodically send requests for screen updates and send mouse/key click information to the server to simulate.

Each video frame is inter-compressed against the previous frame and then intra-compressed with a modified LZW scheme to minimize the amount of data transmitted from server to client.

For more detailed information on VCEP application, please refer to [http://ftp.icpdas.com.tw/pub/cd/winpac\\_am335x/WP-9000-CE7/pc\\_tools/vcep/](http://ftp.icpdas.com.tw/pub/cd/winpac_am335x/WP-9000-CE7/pc_tools/vcep/)



### 3.5. Remote\_Display

The **Remote Display** allows WP-9000-CE7 to be controlled and monitored from a remote location.

This tool is composed of two parts, a client and a server. The server is a program named `cerdisp.exe` running on WP-9000-CE7. The client is a PC-based program named `cerhost.exe` running on the PC.



cerdisp



cerhost

Once a connection is established between the client and server (initiated by the client), the client will periodically send requests for screen updates and send mouse/key click information to the server to simulate.

### 3.6. SendToCOM

The **SendToCOM** uses the serial port to communicate with expansion module. To use the SendToCOM, you can send data to expansion module through the serial port, and receive data from other device through the serial port.

For more information about these commands for communicating with expansion module, please refer to:

[http://www.icpdas.com/root/product/solutions/remote\\_io/rs-485/i-8k\\_i-87k/i-8k\\_i-87k\\_selection.html#b](http://www.icpdas.com/root/product/solutions/remote_io/rs-485/i-8k_i-87k/i-8k_i-87k_selection.html#b)

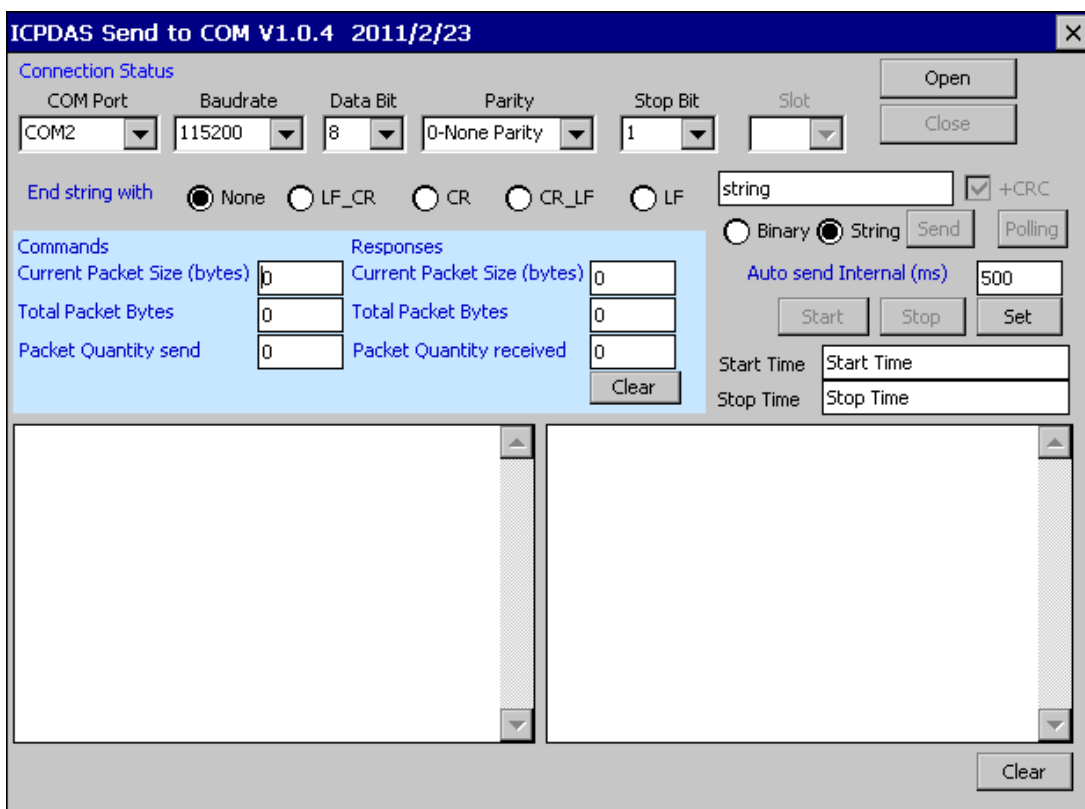

### 3.7. RegEdit

The **RegEdit** provides a hierarchical representation of the registry on a target computer, similar in appearance to the Windows Registry Editor. The standard registry roots are represented; you can add keys beneath a root to point to existing registry keys, or you can add your own keys. Values can be changed for existing keys, or added for new keys, and default keys can be specified. For more information, see Registry Settings Management in Deployment.

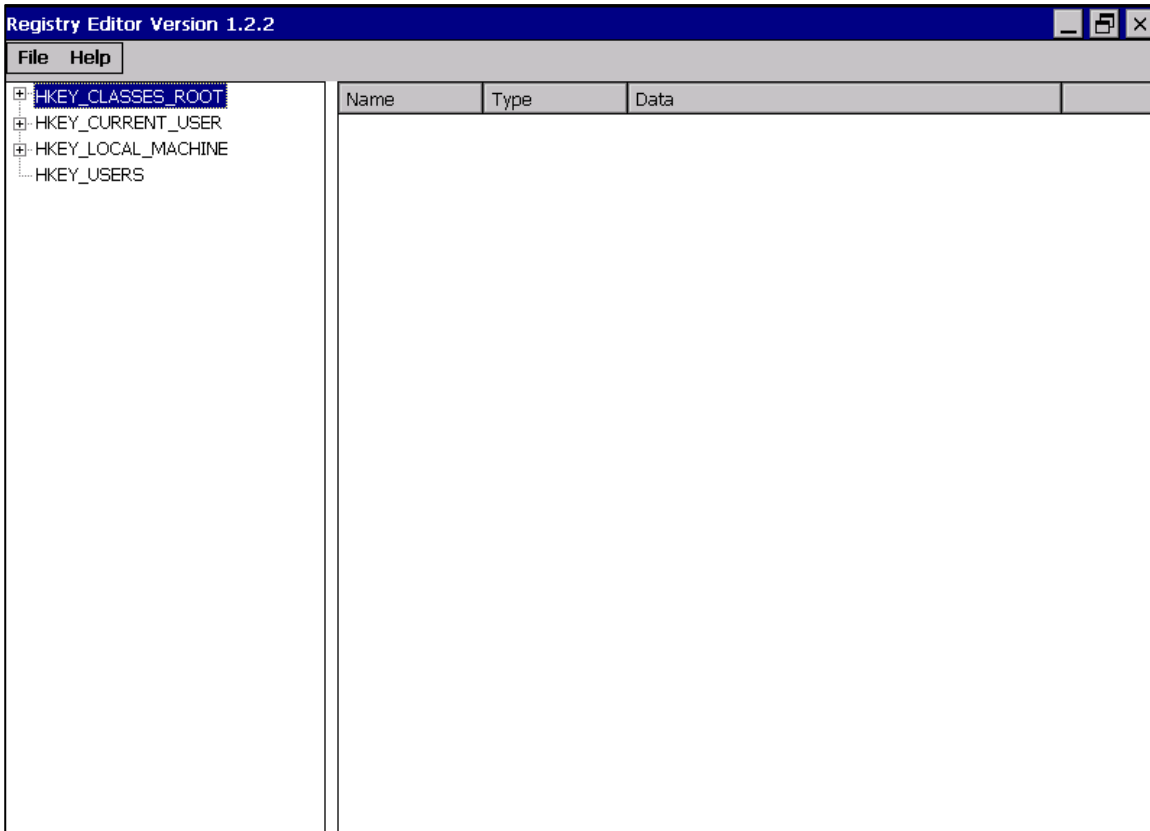

### 3.8. ISQLW35

The **ISQLW35** is a Windows Embedded Compact 7 functionality that implements SQL Server Compact 3.5 Query.

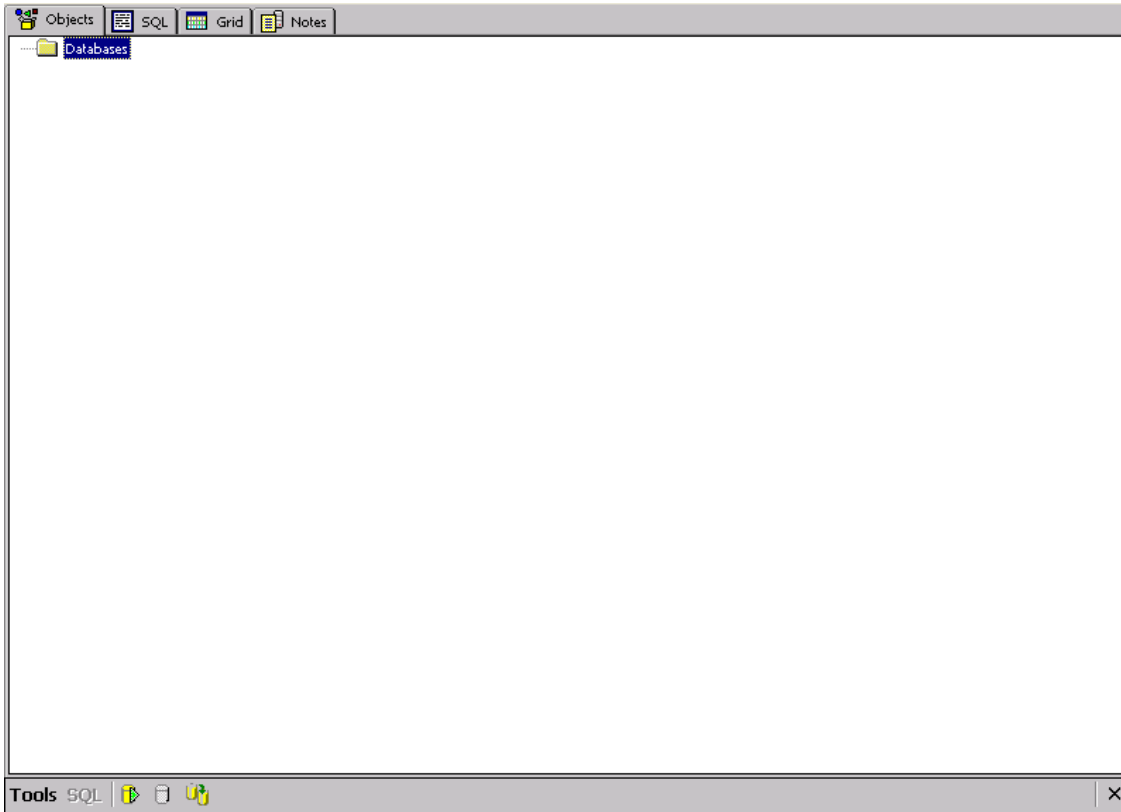

### 3.9. INotepad

The **INotepad** is a common text-only editor. The resulting files have no format tags or styles.

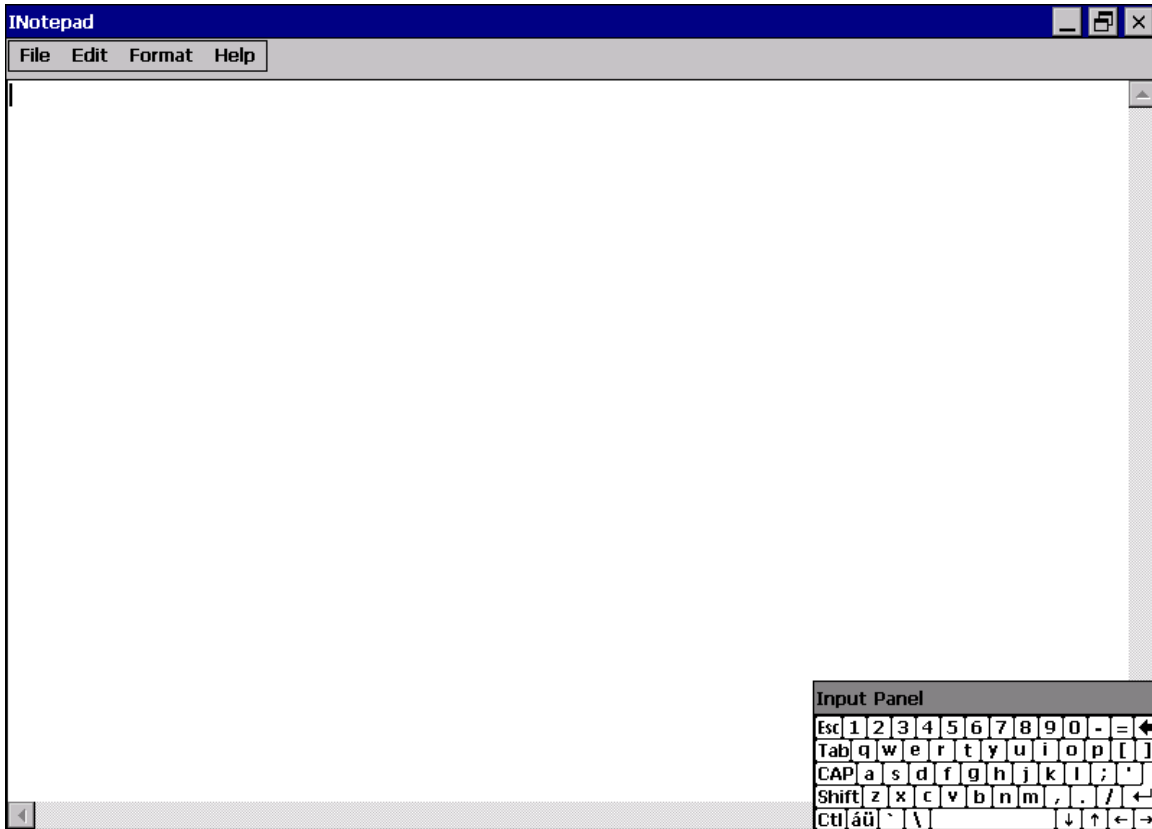

## 4. Your First WP-9000-CE7 Program

This chapter provides a guided tour that describes the steps needed to set-up a development environment, download, install, configure for user programming with WP-9000-CE7 modules.

### 4.1. Setting up the Development Environment

Before writing your first program, ensure that you have the necessary development tool and the corresponding SDKs are installed on your system.

### 4.1.1. Preparing the Development Tools and Programming Languages

WP-9000-CE7 is a Windows CE-based device that supports three programming languages for developing Windows CE applications.

- Visual Basic.NET
- Visual C#
- Visual C++

#### Development Tools

WP-9000-CE7 supports the application development with the Professional Edition application of Visual Studio 2008.



---

#### Tips & Warnings



There are some updates for Visual Studio 2008 to provide support for Windows Embedded Compact 7.

If you have Professional Edition of Visual Studio 2008 are installed, make sure all of the following package are installed

**1. Visual Studio 2008 Service Pack 1**

<http://www.microsoft.com/en-us/download/details.aspx?id=10986>

**2. Visual Studio 2008 update for Windows Embedded Compact 7**

<http://www.microsoft.com/en-us/download/confirmation.aspx?id=11935>

**3. Windows Embedded Compact 7 ATL Update for Visual Studio 2008 SP1**

<http://support.microsoft.com/kb/2468183/en-us>

---

## 4.1.2. Installing the WP-9000-CE7 SDK

The WP-9000-CE7 SDK offers several APIs for customizing the standard features and integrating with other applications, devices and services.

### Step 1: Get the latest version of the WP-9000-CE7 SDK, AM335x\_WINCE7\_SDKV100B03

The WP-9000-CE7 SDK can be found from the CD that was provided with the package or by downloading the latest version from ICP DAS web site.

CD:\WP-9000\SDK\PlatformSDK\

[http://ftp.icpdas.com/pub/cd/winpac\\_am335x/wp-9000/sdk/platformsdk/](http://ftp.icpdas.com/pub/cd/winpac_am335x/wp-9000/sdk/platformsdk/)

### Step 2: Execute the AM335x\_WINCE7\_SDK\_YYYYMMDD.msi

Follow the prompts until the installation process is complete.

### Step 3: Execute the VisualStudioDeviceWindowsEmbeddedCompact7

Follow the prompts until the installation process is complete.



### 4.1.3. Setting up the Global Compiler Settings (for Visual C++)

The directories can be specified where the compiler will search for include files and libraries.

#### Step 1: Start Visual Studio 2008



#### Step 2: On the Tools menu, click Options...

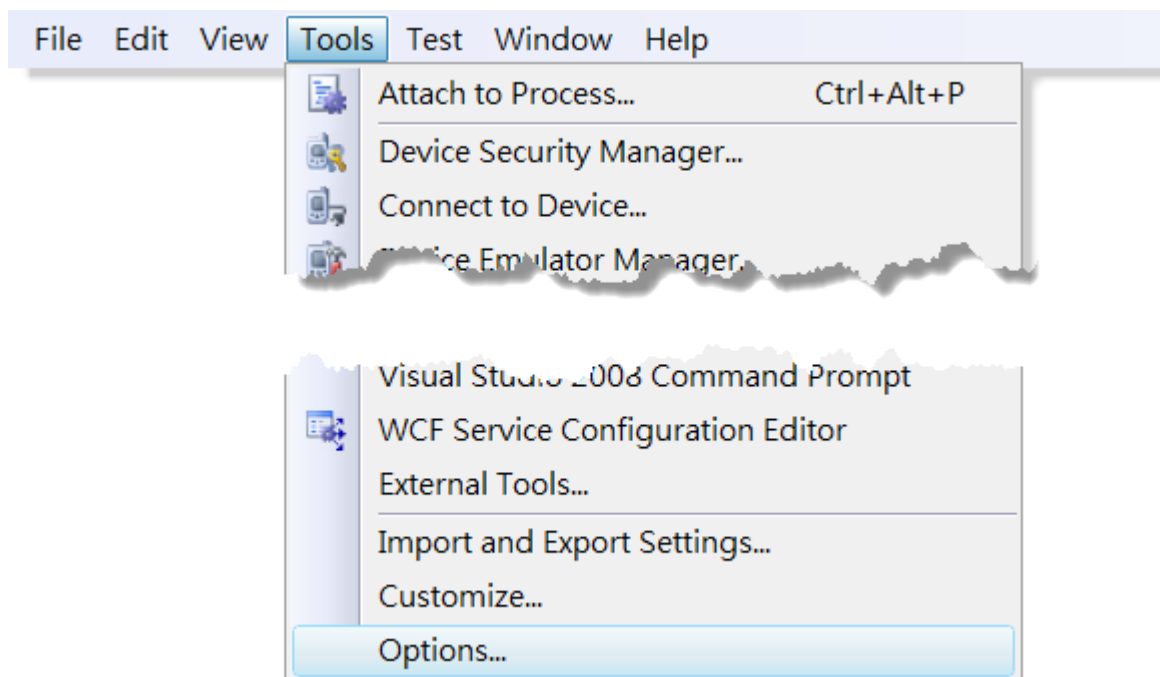

**Step 3: In the Options dialog box, expand the Projects folder, and then click the VC++ Directories**

**Step 4: In the Show directories for: drop-down list, select Include files**

**Step 5: Use the buttons in the Options dialog box to add additional include paths**

The path of “\$(VCInstallDir)ce7\include” and “\$(VCInstallDir)ce7\atlmfc\include” must be moved to the top of the list.

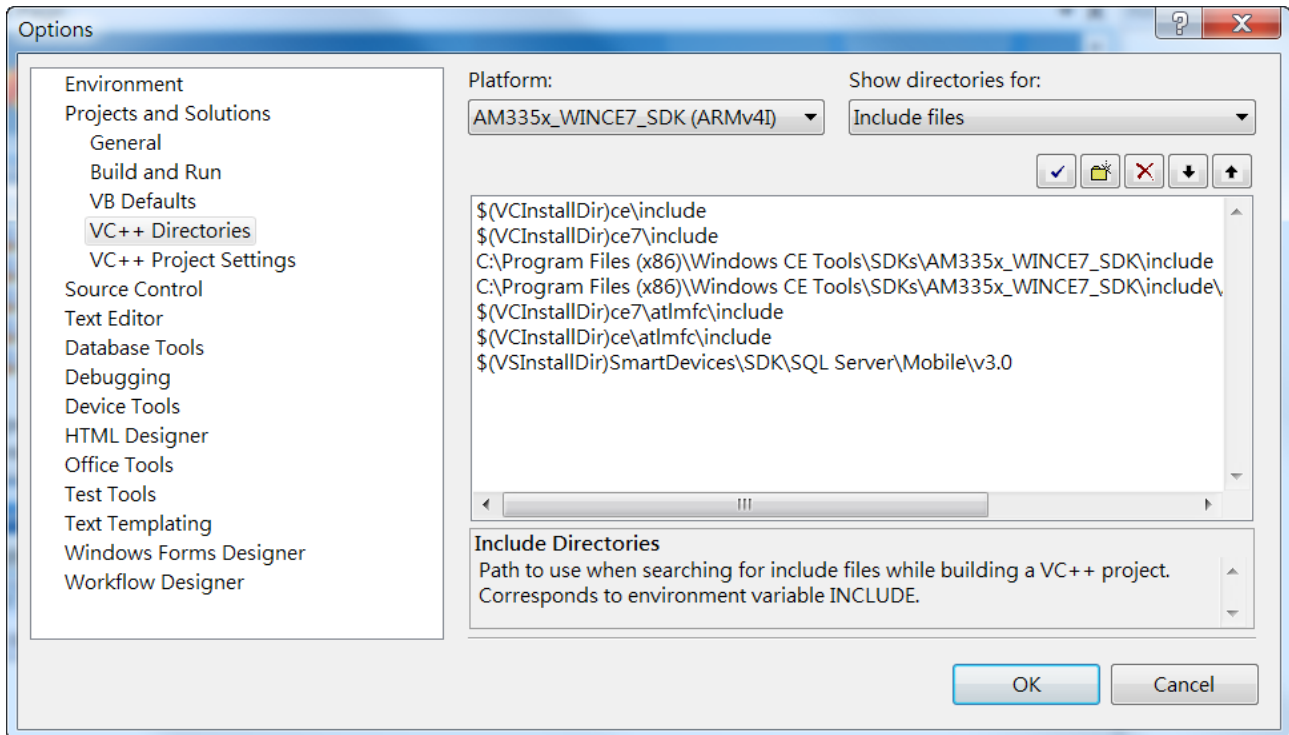

## 4.2. First WP-9000-CE7 Program in VB.NET

The best way to learn programming with WP-9000-CE7 is to actually create a WP-9000-CE7 program.

The example below demonstrates how to create a demo program running on WP-9000-CE7 with VB.NET.

To create a demo program with VB.NET that includes the following main steps:

1. Create a new project
2. Specify the path of the PAC reference
3. Add the control to the form
4. Add the event handling for the control
5. Upload the application to WP-9000-CE7
6. Execute the application on WP-9000-CE7

All main steps will be described in the following subsection.

In this tutorial, we will assume that you have installed WP-9000-CE7 SDK on PC and used the Visual Studio 2008 for application development.

### 4.2.1. Create a new project

The Visual VB.net project template is a composite control that you use in this example creates a new project with this user control.

#### Step 1: Start Visual Studio 2008



#### Step 2: On the File menu, point to New, and then click Project

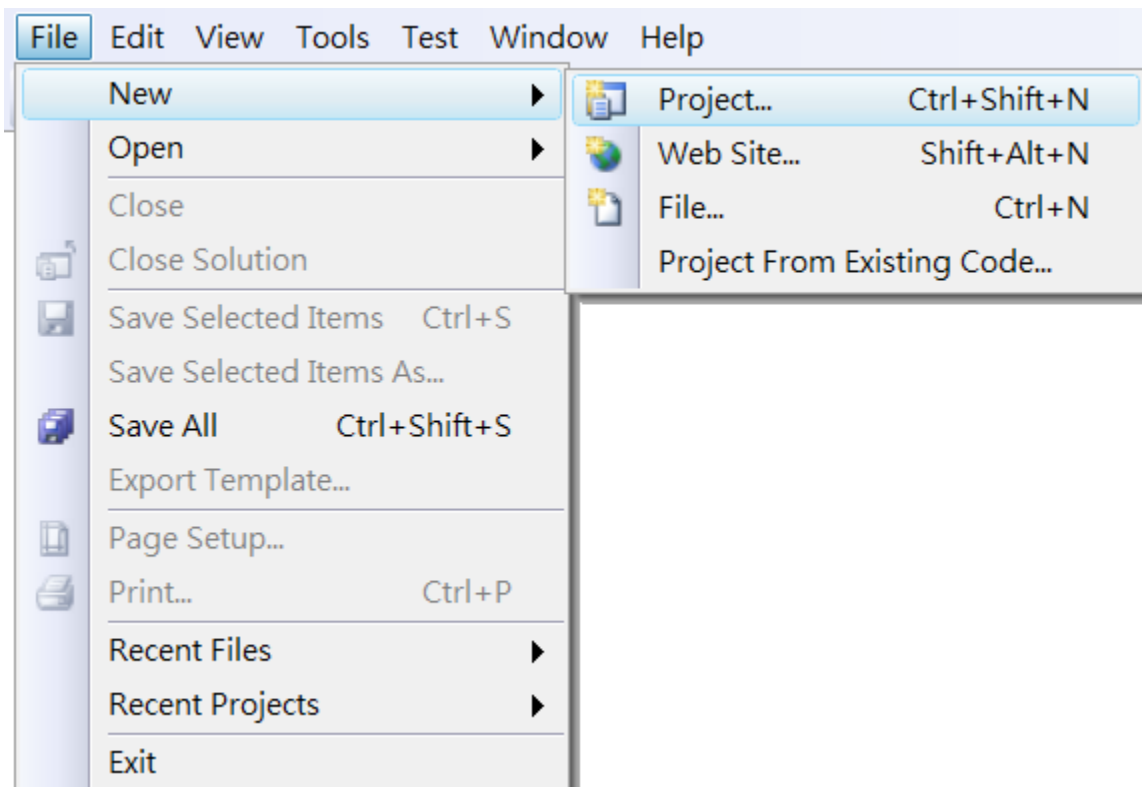

**Step 3: In the Project types pane, expand Visual Basic node and select Smart Device**

**Step 4: In the list of Templates, select Smart Device Project**

**Step 5: Specify a name and a location for the application and then click OK**

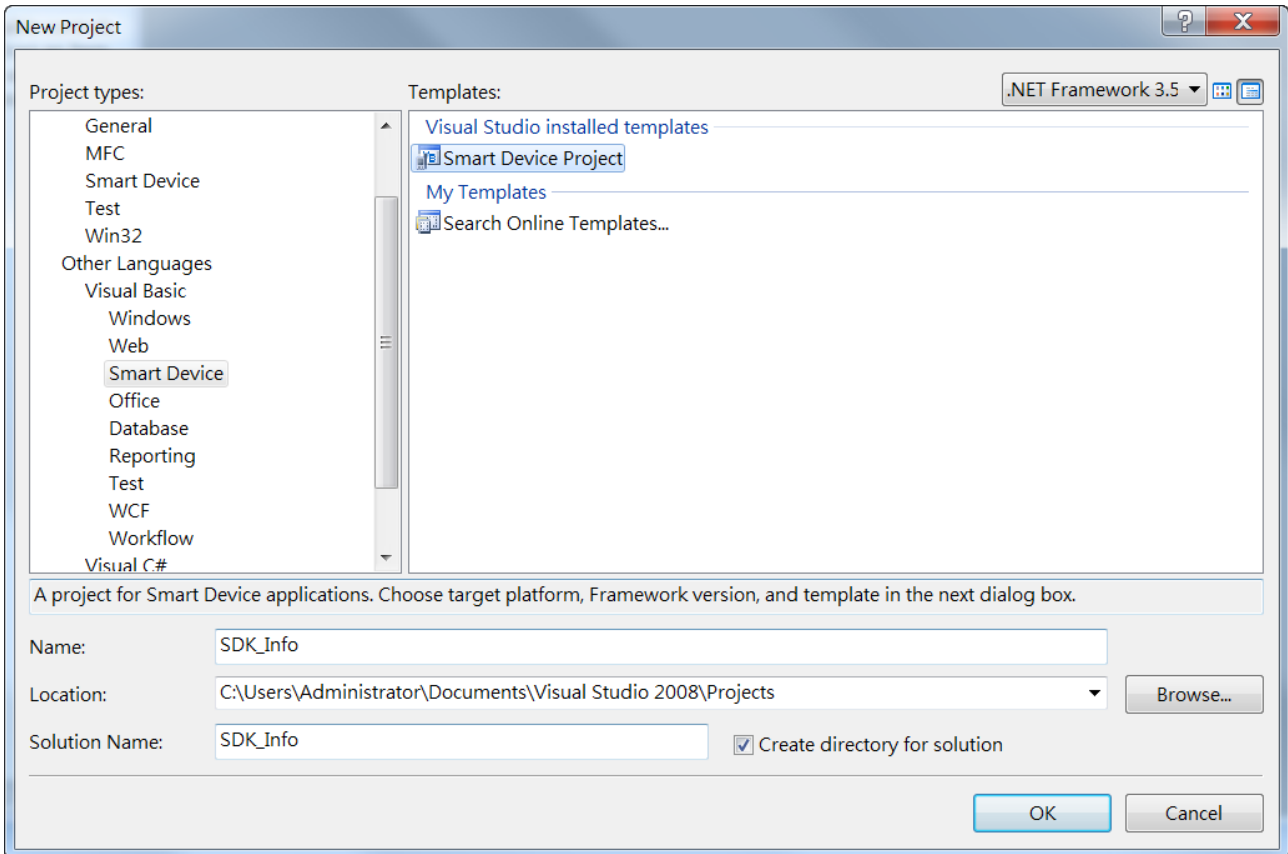

**Step 6: In the Target platform, select Windows CE**

**Step 7: In the .NET Compact Framework version, select .NET Compact Framework Version 3.5.**

### Tips & Warnings



Windows CE7 only supports .NET Compact Framework Version 3.5, if your application uses .NET Compact Framework Version 2.0 there is no guarantee that the program will function correctly.

**Step 8: In the list of templates, select Device Application. Click OK**

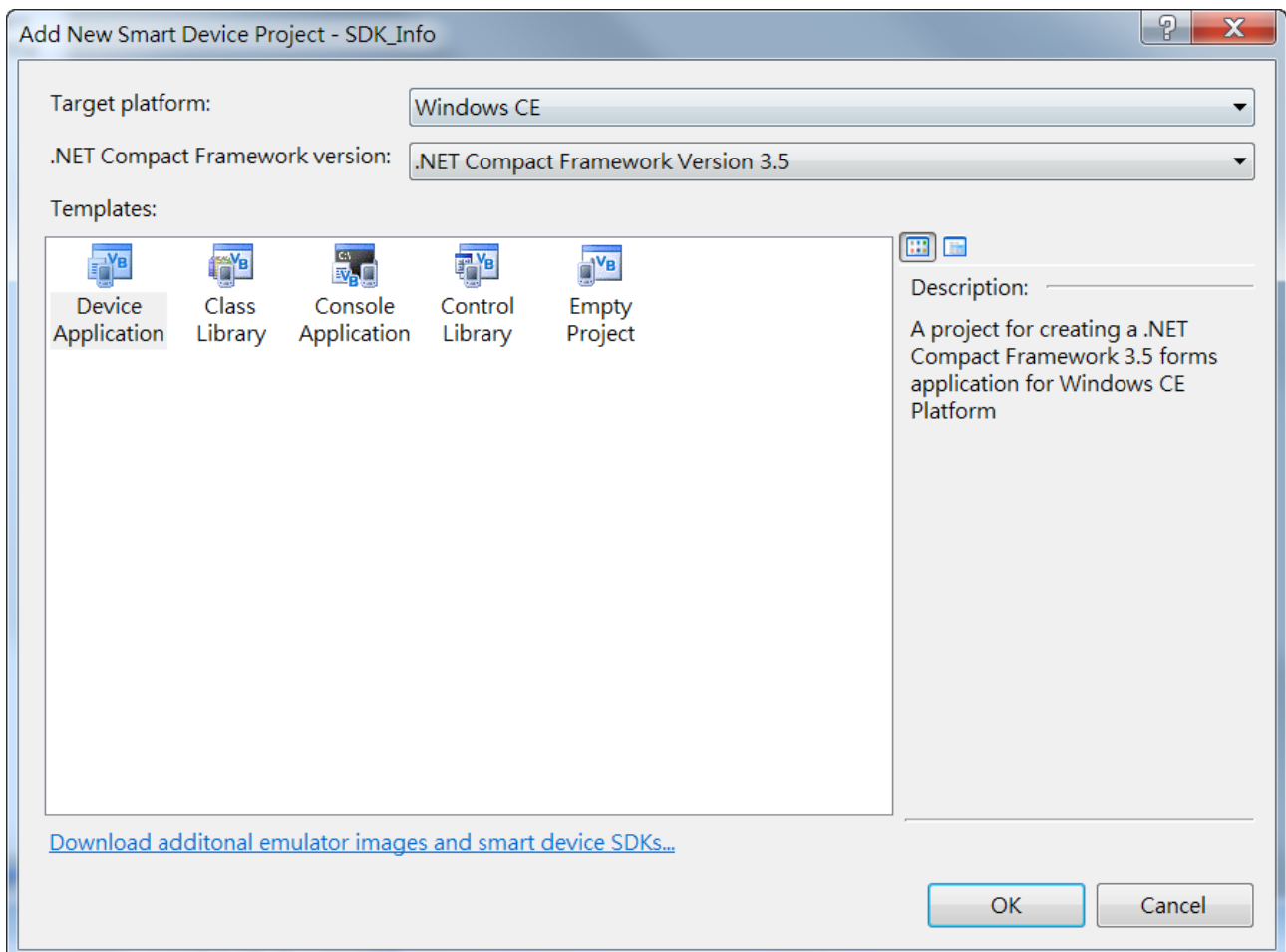

## 4.2.2. Specify the path of the PAC reference

The PAC SDK provides a complete solution to integrate with WP-9000-CE7 and it's compatible with Visual C#, Visual Basic.NET and C++. In order to use a component in your application, you must first add a reference to it.

### Step1: Get the PACNET.dll



The PACNET.dll can be found from the CD that was provided with the package or by downloading the latest version from ICP DAS web site.

CD:\WP-9000\SDK\PACNET\

[http://ftp.icpdas.com/pub/cd/winpac\\_am335x/wp-9000/sdk/pacnet/](http://ftp.icpdas.com/pub/cd/winpac_am335x/wp-9000/sdk/pacnet/)

### Step 2: On the Project menu, and then click Add Reference...

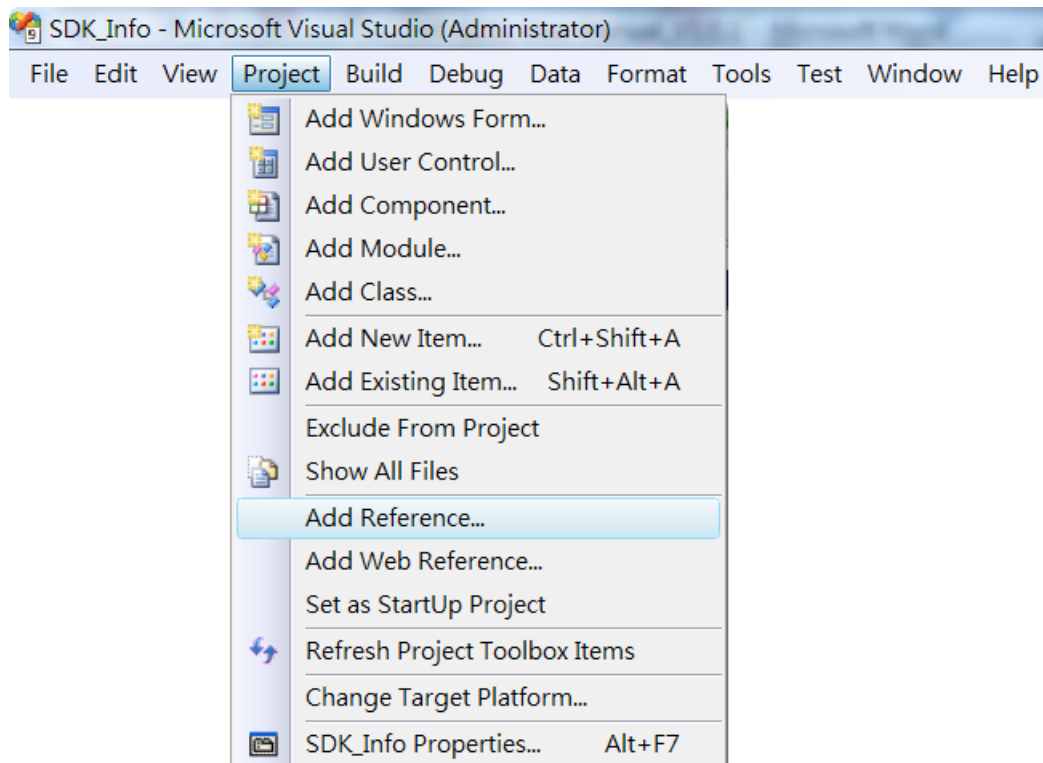

**Step 3: On the Browse tab and browse to where the PACNET.dll are installed, and then click OK**

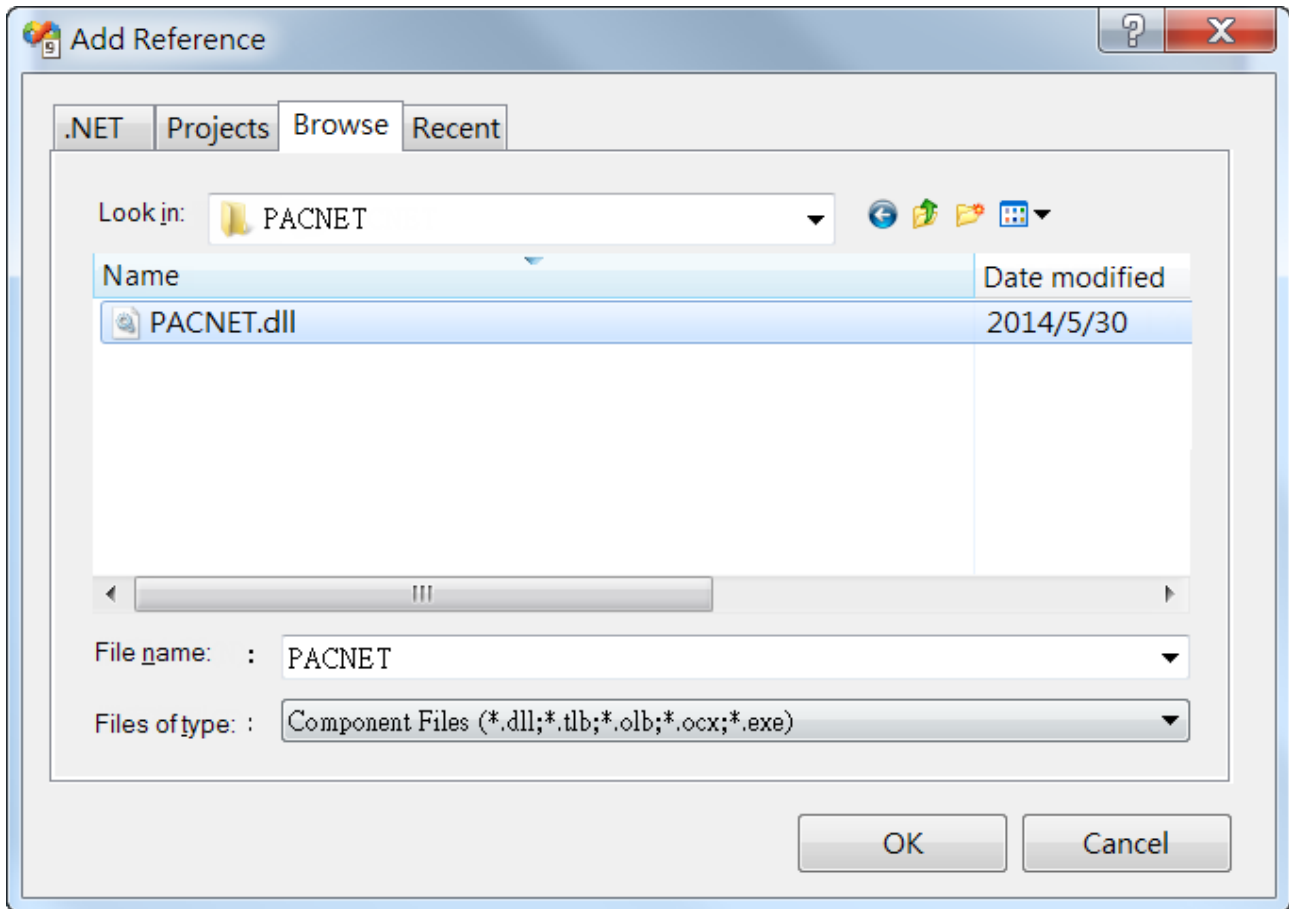



### 4.2.3. Add the control to the form

You can drag various controls from the Toolbox onto the form. These controls are not really "live"; they are just images that are convenient to move around on the form into a precise location.

After you add a control to your form, you can use the Properties window to set its properties, such as background color and default text. The values that you specify in the Properties window are the initial values that will be assigned to that property when the control is created at run time.

#### Step 1: On the Toolbox panel, drag a Button control onto the form

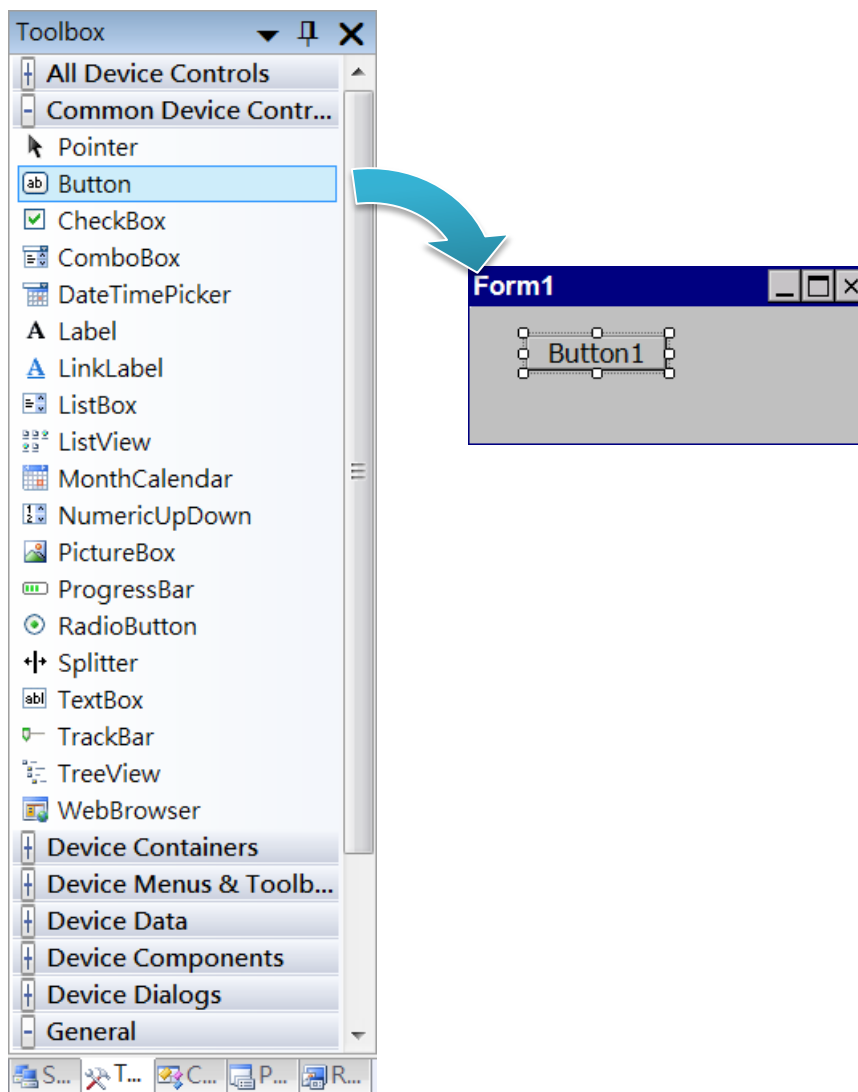

**Step 2: On the Properties panel, type Check the SDK version in the Text field**

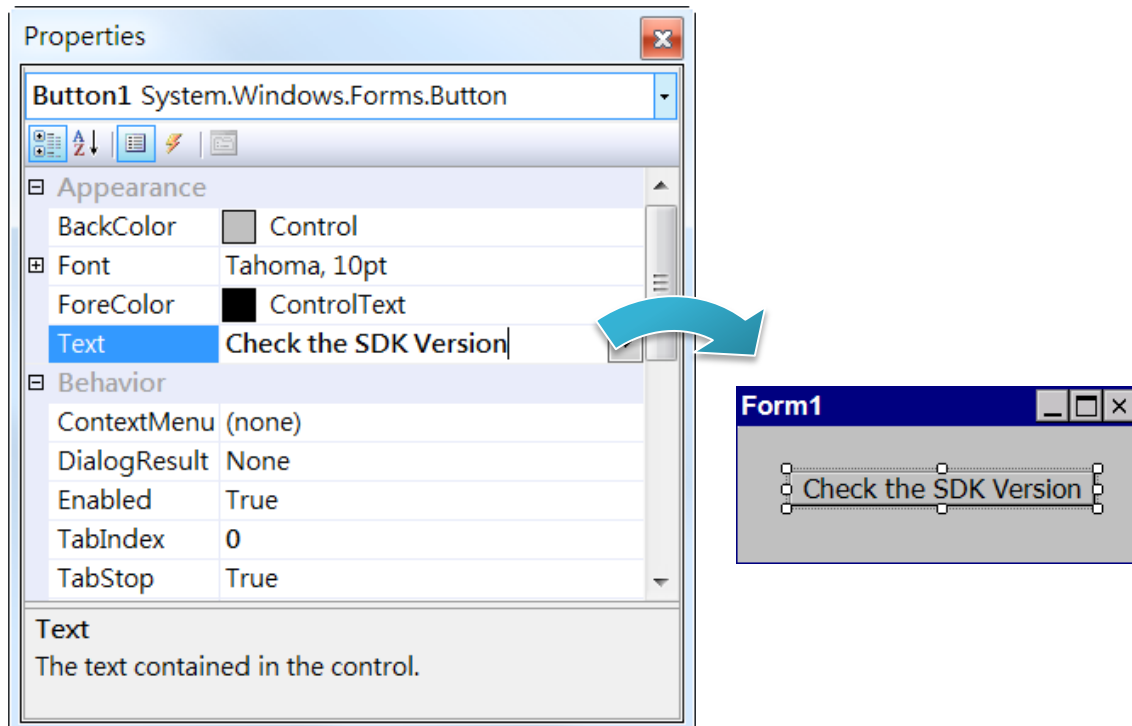

#### 4.2.4. Add the event handling for the control

You have finished the design stage of your application and are at the point when you can start adding some code to provide the program's functionality.

##### Step 1: Double-click the button on the form

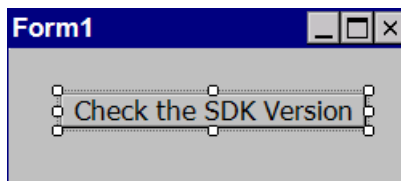

##### Step 2: Inserting the following code

```
Dim data(30) As Byte  
PACNET.Sys.GetSDKVersion(data)  
MessageBox.Show(PACNET.MISC.WideString(data))
```

```
Public Class Form1  
    Private Sub Button1_Click(ByVal sender As System.Object, ByVal e As  
        Dim data(30) As Byte  
        PACNET.Sys.GetSDKVersion(data)  
        MessageBox.Show(PACNET.MISC.WideString(data))  
    End Sub  
End Class
```

#### Tips & Warnings



The "PACNET" of "using PACNET" is case- sensitive.

#### 4.2.5. Upload the application to WP-9000-CE7

WP-9000-CE7 supports FTP server service. You can upload files to WP-9000-CE7 or download files from a public FTP server.

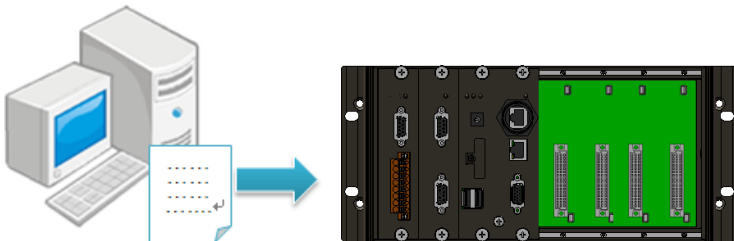

**Step 1: On the Build menu, and then click Build [Project Name]**

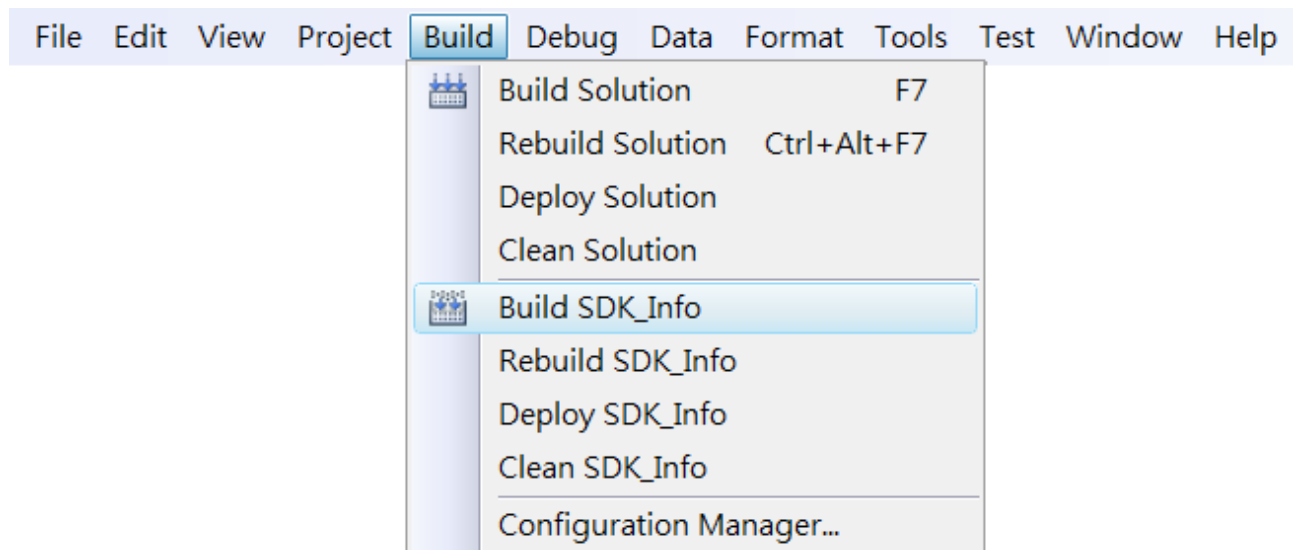

**Step 2: Open the browser and type the IP address of WP-9000-CE7**

**Step 3: Upload the application and the corresponding PACNET.dll files to WP-9000-CE7**

### Tips & Warnings

---



For applications programming in C# and VB.net with .net compact framework, when executing these application on WP-9000-CE7, the corresponding PACNET.dll must be in the same directory as the .exe file.

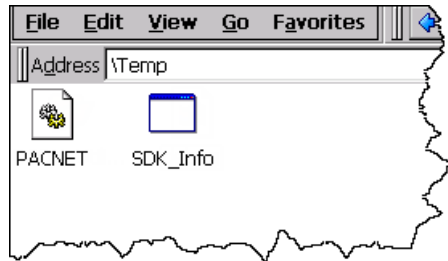

#### 4.2.6. Execute the application on WP-9000-CE7

After uploading the application to WP-9000-CE7, you can just double-click it on WP-9000-CE7 to execute it.

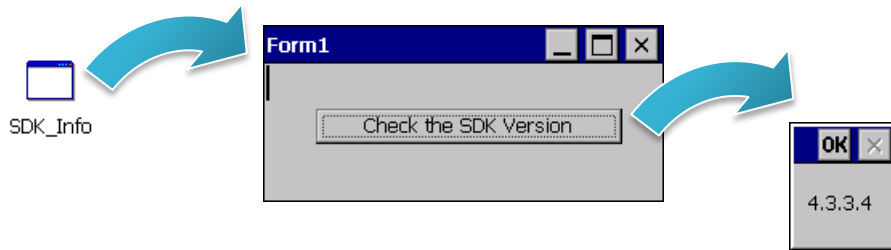

### 4.3. First WP-9000-CE7 Program in Visual C#

The best way to learn programming with WP-9000-CE7 is to actually create a WP-9000-CE7 program.

The example below demonstrates how to create a demo program running on WP-9000-CE7 with Visual C#.

To create a demo program with Visual C# that includes the following main steps:

1. Create a new project
2. Specify the path of the PAC reference
3. Add the control to the form
4. Add the event handling for the control
5. Upload the application to WP-9000-CE7
6. Execute the application on WP-9000-CE7

All main steps will be described in the following subsection.

In this tutorial, we will assume that you have installed WP-9000-CE7 SDK on PC and used the Visual Studio 2008 for application development.

### 4.3.1. Create a new project

The Visual C# project template is a composite control that you use in this example creates a new project with this user control.

#### Step 1: Start Visual Studio 2008



#### Step 2: On the File menu, point to New, and then click Project

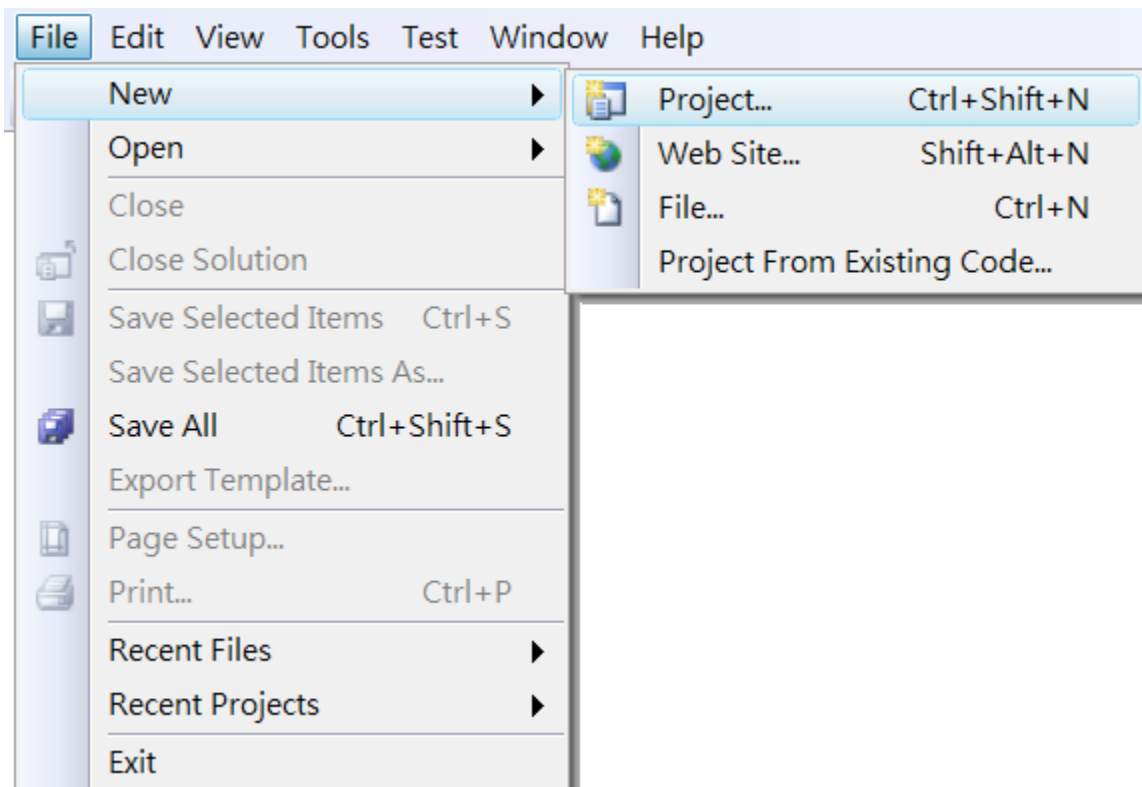



**Step 3: In the Project types pane, expand Visual C# node and select Smart Device**

**Step 4: In the list of Templates, select Smart Device Project**

**Step 5: Specify a name and a location for the application and then click OK**

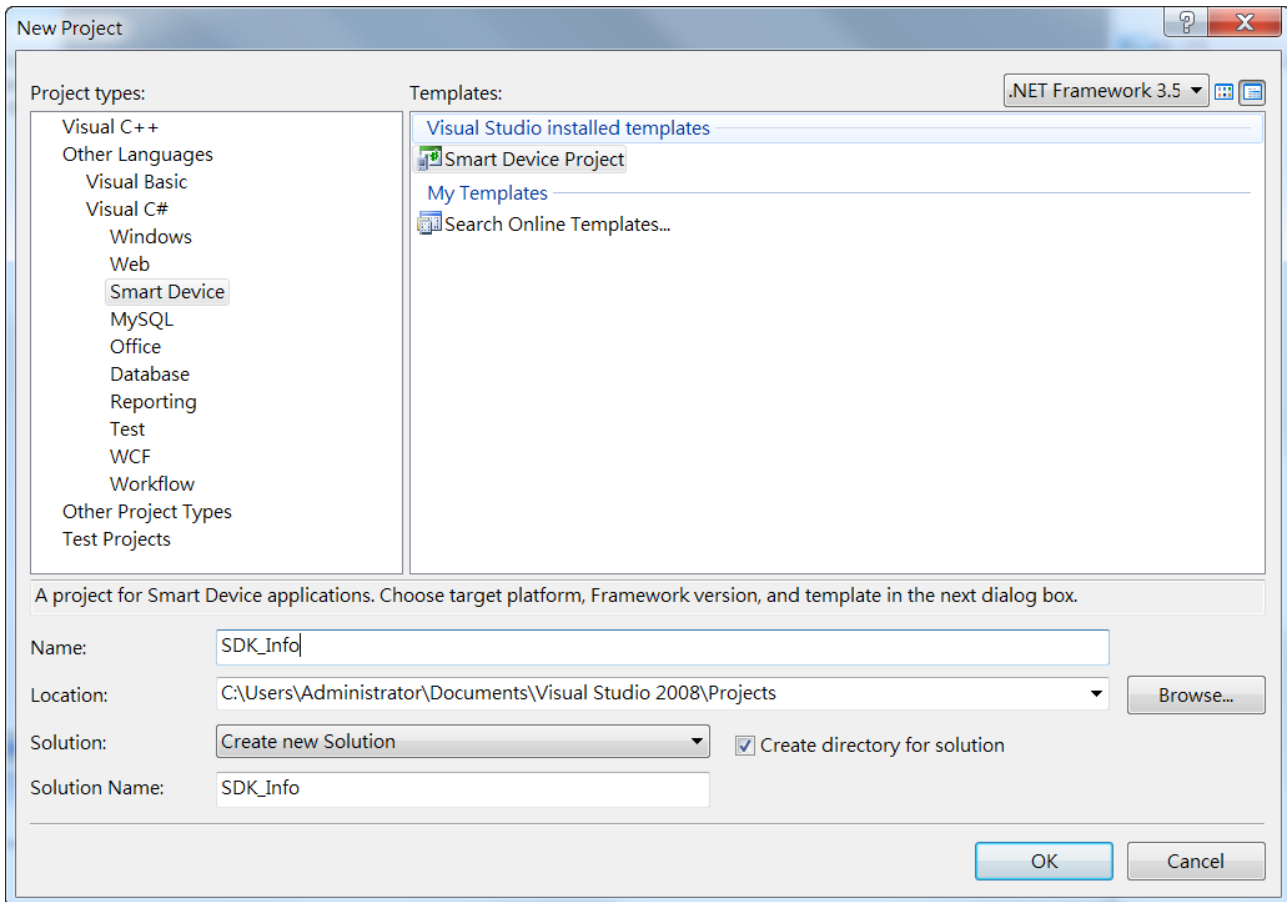

**Step 6: In the Target platform, select Windows CE**

**Step 7: In the .NET Compact Framework version, select .NET Compact Framework Version 3.5.**

### Tips & Warnings

---



Windows CE7 only supports .NET Compact Framework Version 3.5, if your application uses .NET Compact Framework Version 2.0 there is no guarantee that the program will function correctly.

---

**Step 8: In the list of templates, select Device Application. Click OK**

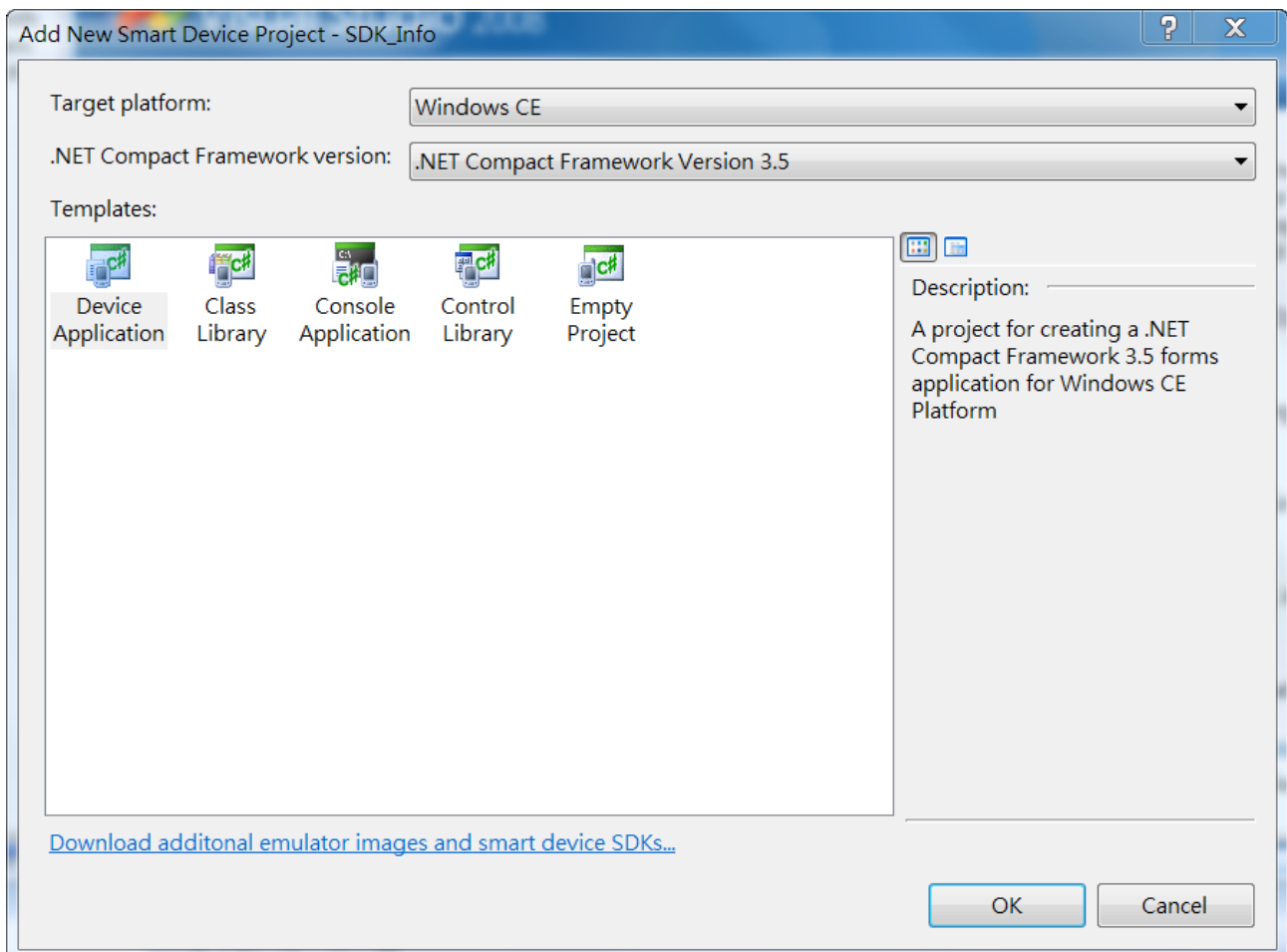

### 4.3.2. Specify the path of the PAC reference

The PAC SDK provides a complete solution to integrate with WP-9000-CE7 and it's compatible with Visual C#, Visual Basic.NET and C++. In order to use a component in your application, you must first add a reference to it.

#### Step1: Get the PACNET.dll



The PACNET.dll can be found from the CD that was provided with the package or by downloading the latest version from ICP DAS web site.

CD:\WP-9000\SDK\PACNET\

[http://ftp.icpdas.com/pub/cd/winpac\\_am335x/wp-9000/sdk/pacnet/](http://ftp.icpdas.com/pub/cd/winpac_am335x/wp-9000/sdk/pacnet/)

#### Step 2: On the Project menu, and then click Add Reference...

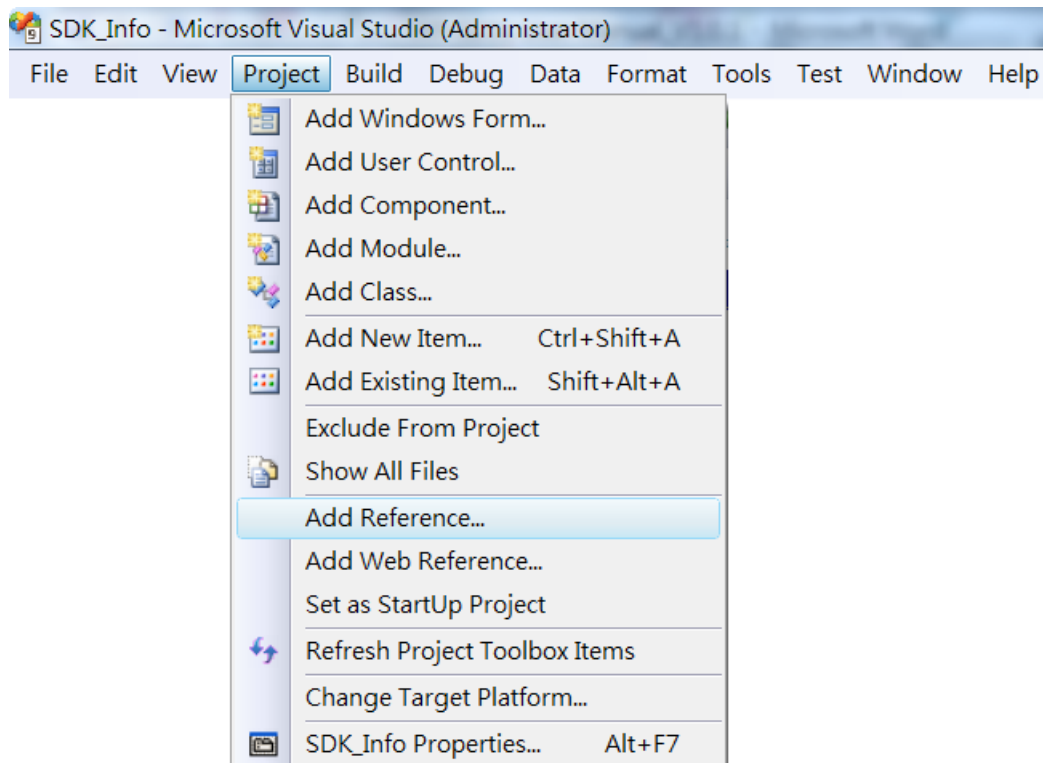

**Step 3: On the Browse tab and browse to where the PACNET.dll are installed, and then click OK**

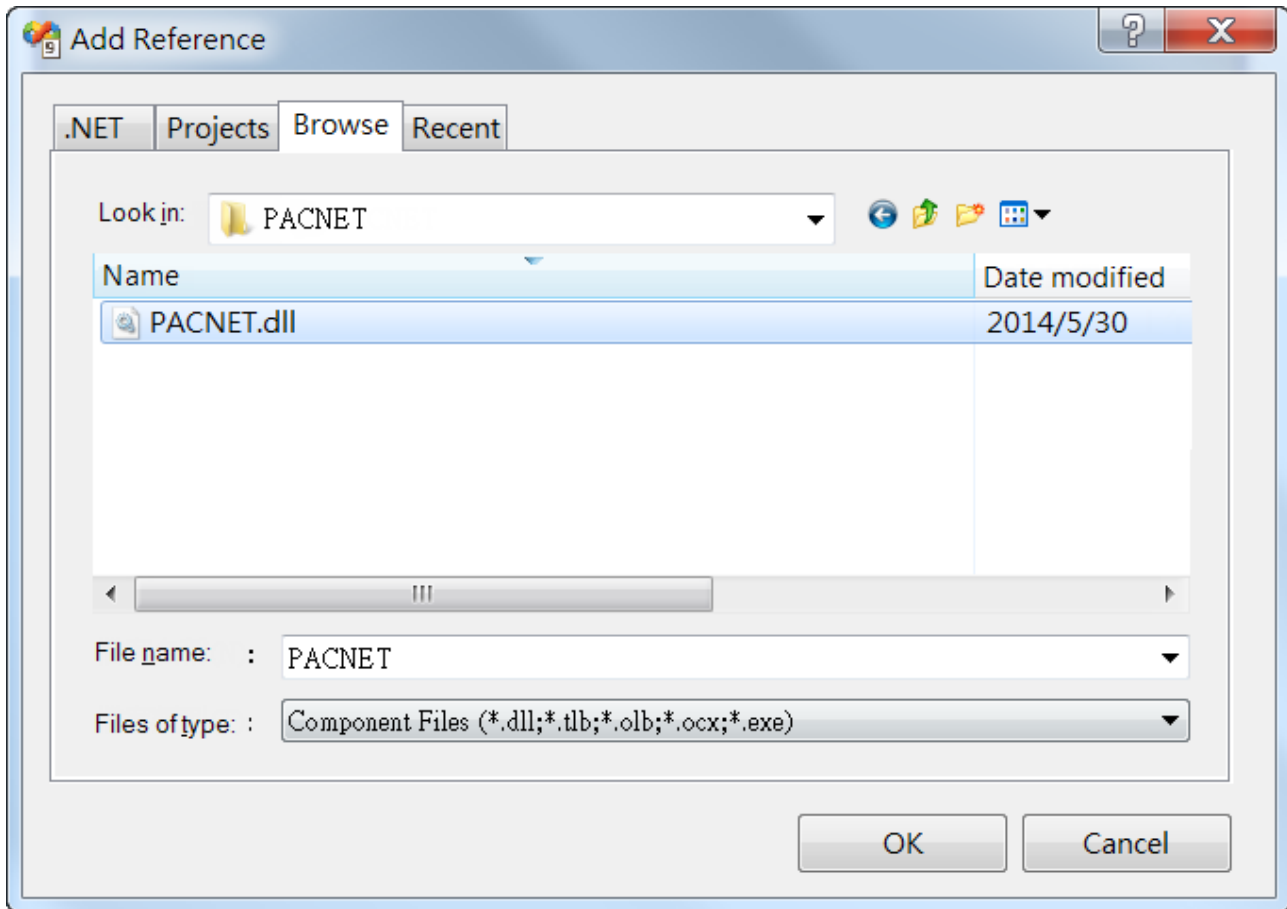

### 4.3.3. Add the control to the form

You can drag various controls from the Toolbox onto the form. These controls are not really "live"; they are just images that are convenient to move around on the form into a precise location.

After you add a control to your form, you can use the Properties window to set its properties, such as background color and default text. The values that you specify in the Properties window are the initial values that will be assigned to that property when the control is created at run time.

#### Step 1: On the Toolbox panel, drag a Button control onto the form

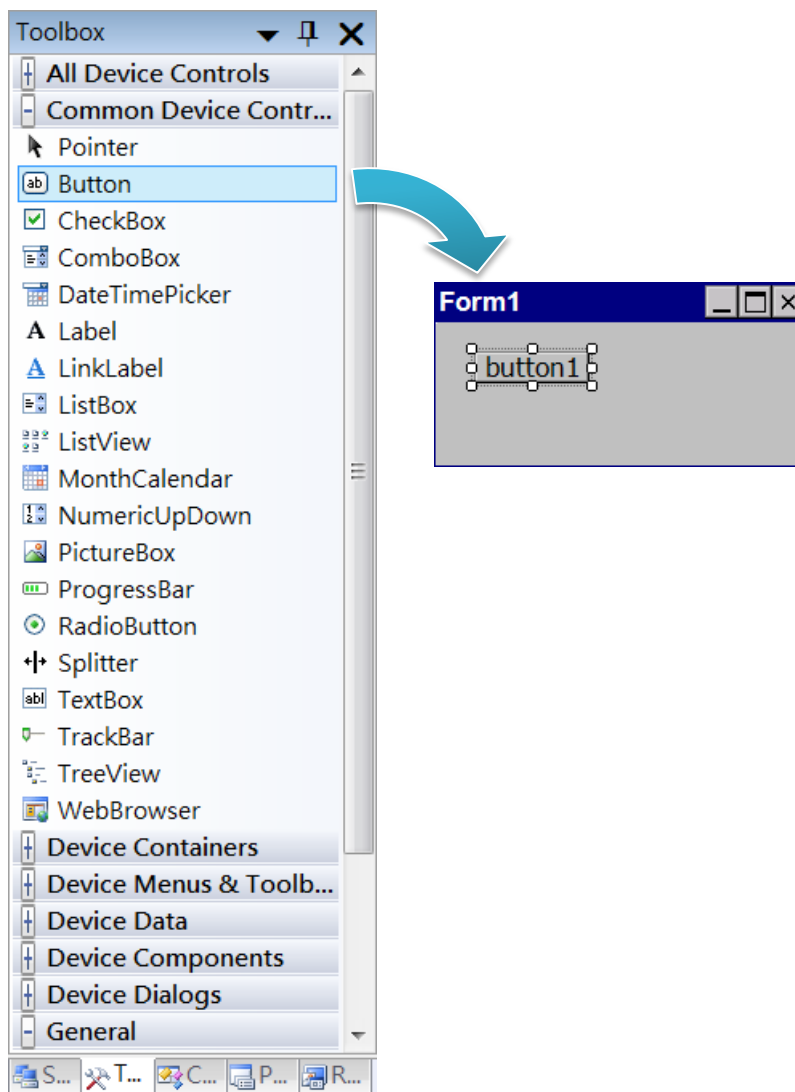

**Step 2: On the Properties panel, type Check the SDK version in the Text field**

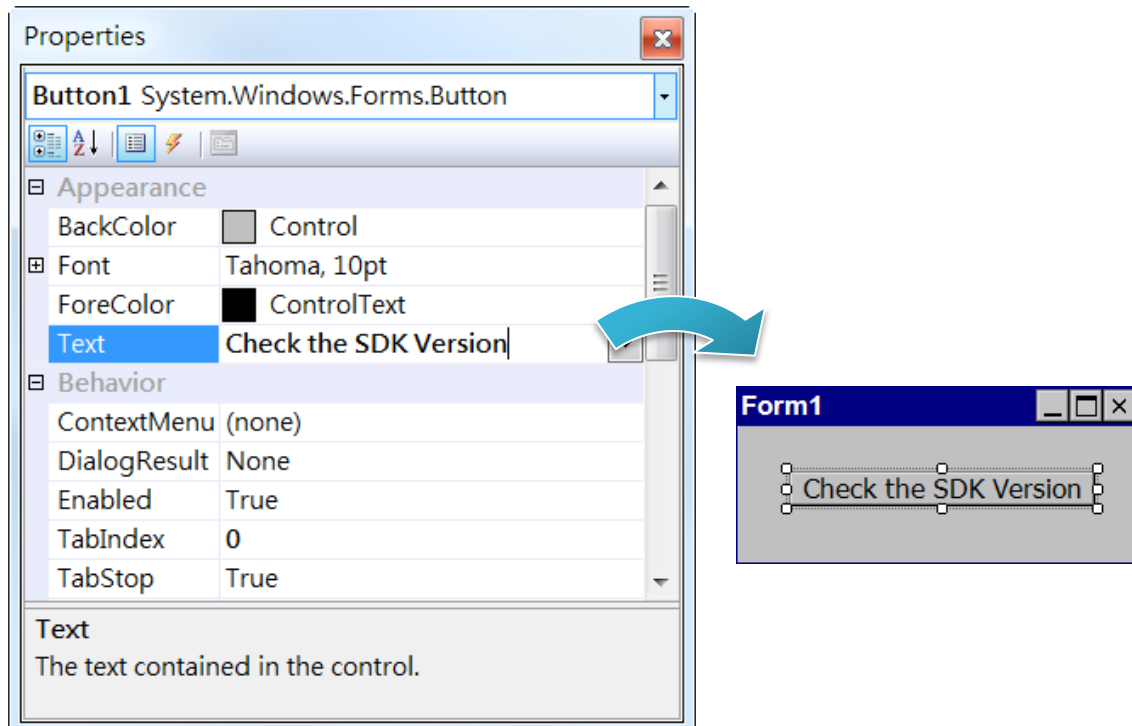

#### 4.3.4. Add the event handling for the control

You have finished the design stage of your application and are at the point when you can start adding some code to provide the program's functionality.

##### Step 1: Double-click the button on the form

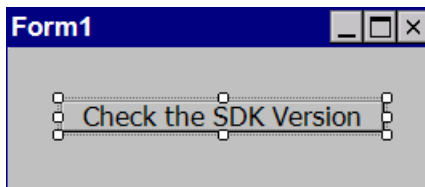

##### Step 2: Inserting the following code

```
byte[] data = new byte[30];  
PACNET.Sys.GetSDKVersion(data);  
MessageBox.Show(PACNET.MISC.WideString(data));
```

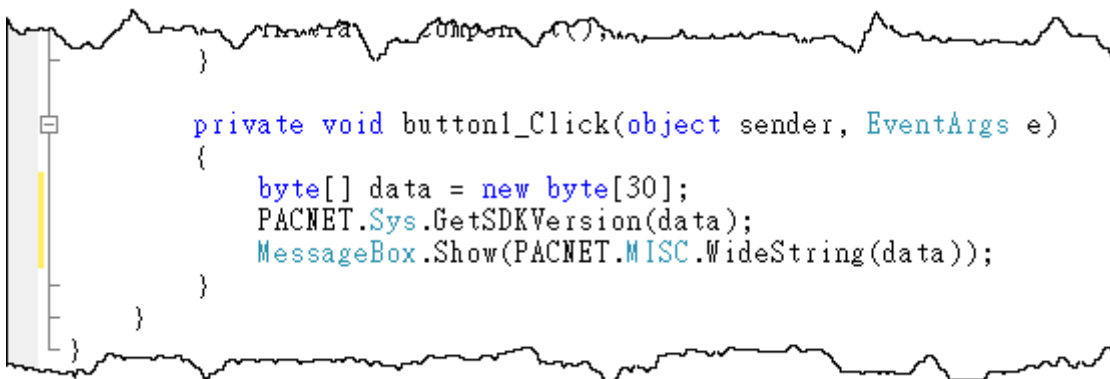

#### Tips & Warnings



The "PACNET" of "using PACNET" is case-sensitive.

### 4.3.5. Upload the application to WP-9000-CE7

WP-9000-CE7 supports FTP server service. You can upload files to WP-9000-CE7 or download files from a public FTP server.

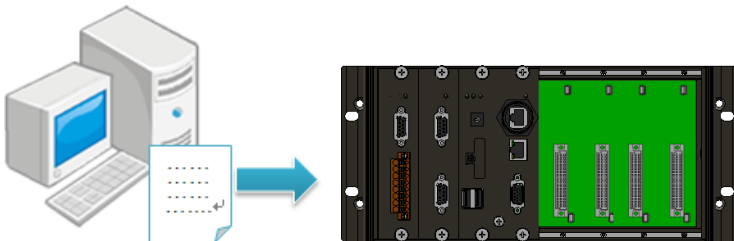

**Step 1: On the Build menu, and then click Build [Project Name]**

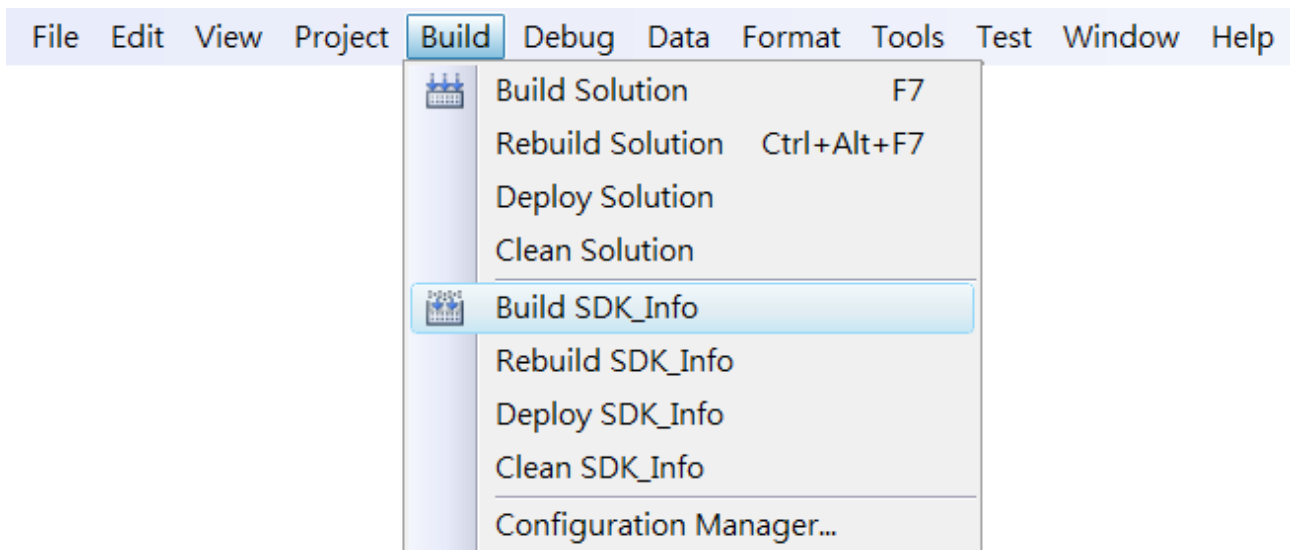



**Step 2: Open the browser and type the IP address of WP-9000-CE7**

**Step 3: Upload the application and the corresponding PACNET.dll files to WP-9000-CE7**

### Tips & Warnings

---



For applications programming in C# and VB.net with .net compact framework, when executing these application on WP-9000-CE7, the corresponding PACNET.dll must be in the same directory as the .exe file.

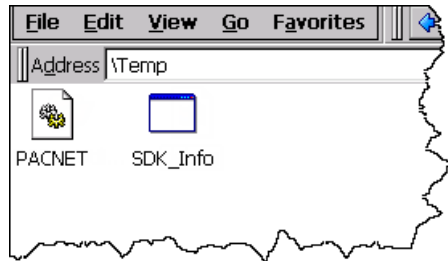

### 4.3.6. Execute the application on WP-9000-CE7

After uploading the application to WP-9000-CE7, you can just double-click it on WP-9000-CE7 to execute it.

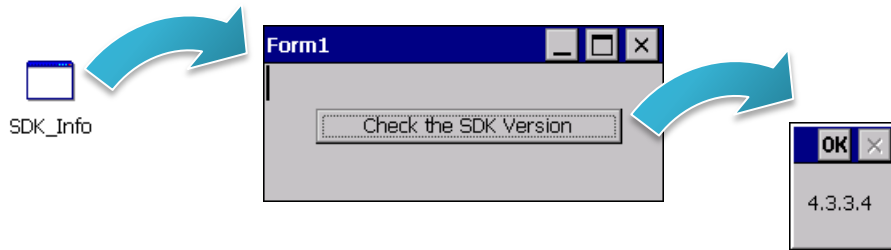

## 4.4. First WP-9000-CE7 Program in Visual C++

The best way to learn programming with WP-9000-CE7 is to actually create a WP-9000-CE7 program.

The example below demonstrates how to create a demo program running on WP-9000-CE7 with Visual C++.

To create a demo program with Visual C# that includes the following main steps:

1. Create a new project
2. Configure the Platform
3. Include the Header files and Libraries of the PAC SDK
4. Add the control to the form
5. Add the event handling for the control
6. Upload the application to WP-9000-CE7
7. Execute the application on WP-9000-CE7

All main steps will be described in the following subsection.

In this tutorial, we will assume that you have installed WP-9000-CE7 SDK on PC and used the Visual Studio 2008 for application development.

#### 4.4.1. Create a new project

The Visual C# project template is a composite control that you use in this example creates a new project with this user control.

##### Step 1: Start Visual Studio 2008



##### Step 2: On the File menu, point to New, and then click Project

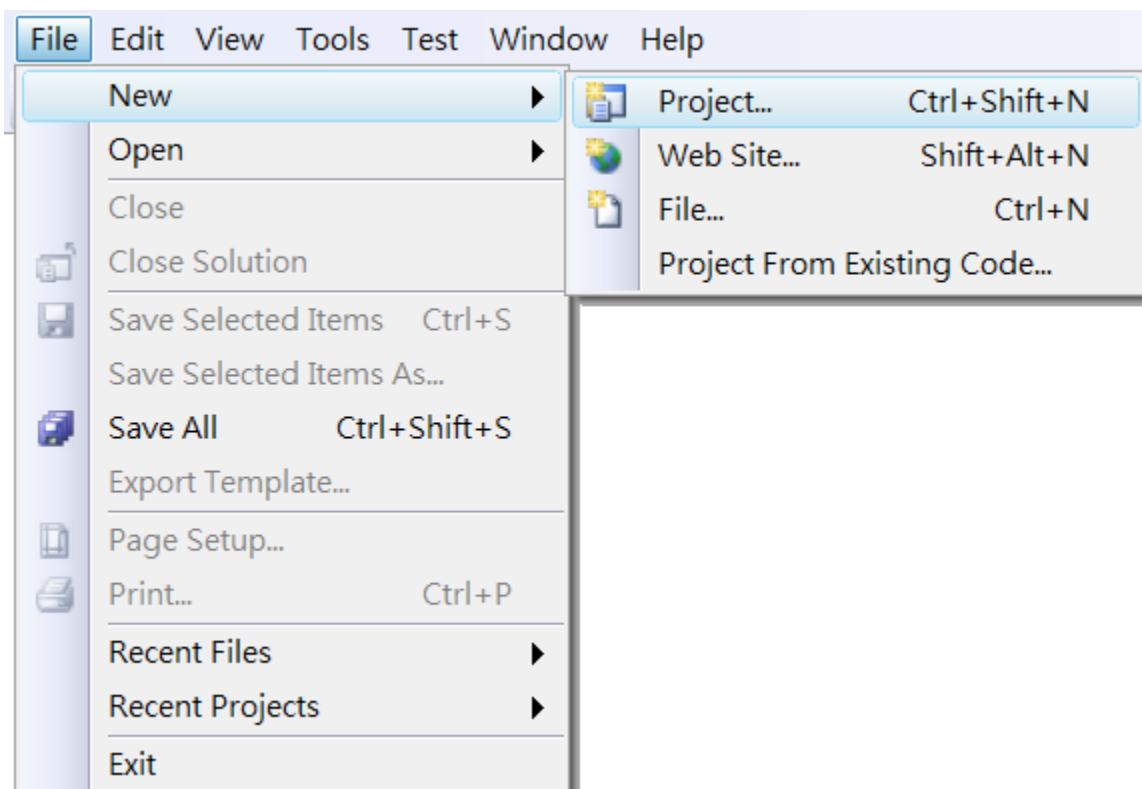

**Step 3:** In the Project types pane, expand Visual C++ node and select Smart Device

**Step 4:** In the list of Templates, select MFC Smart Device Application

**Step 5:** Specify a name and a location for the application and then click OK

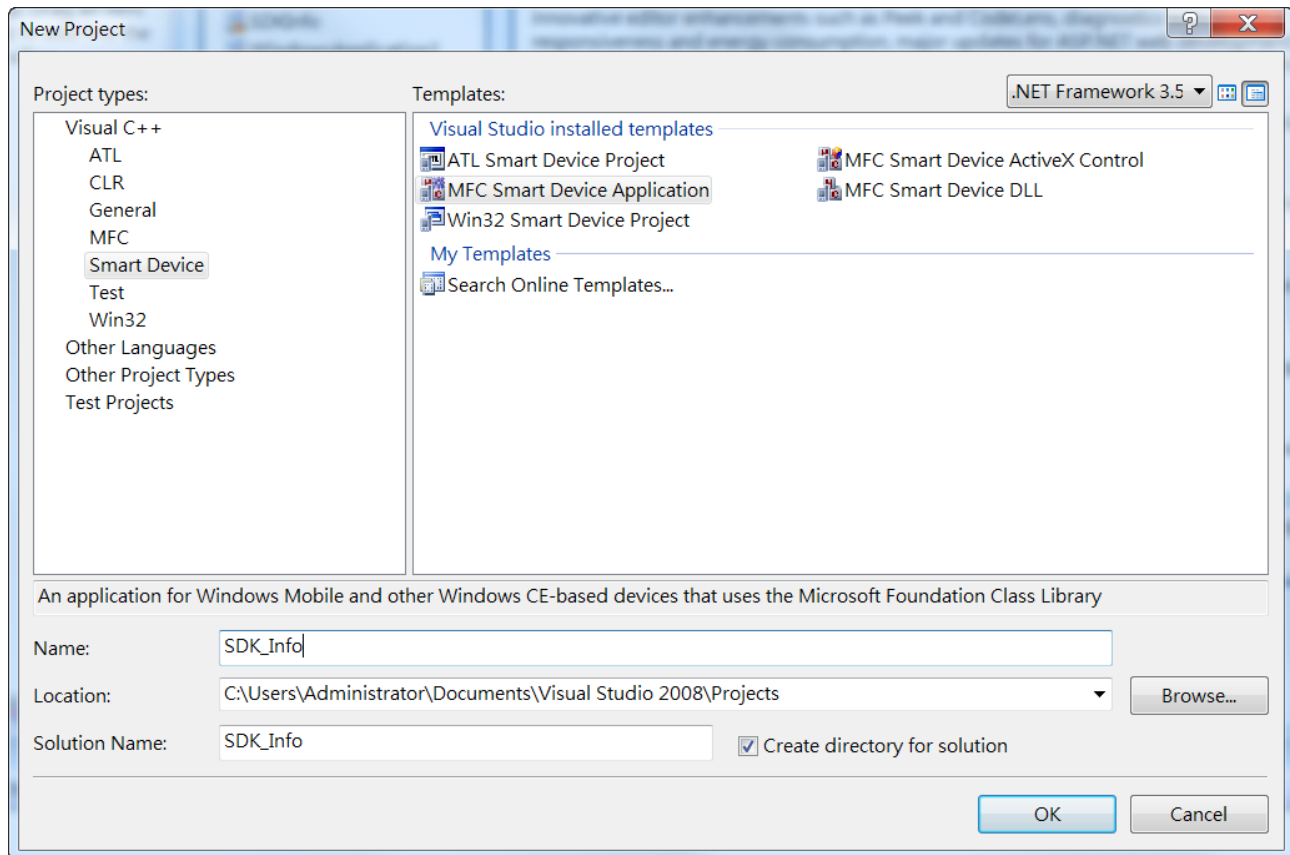

**Step 6: On the first page of the wizard, click Next**

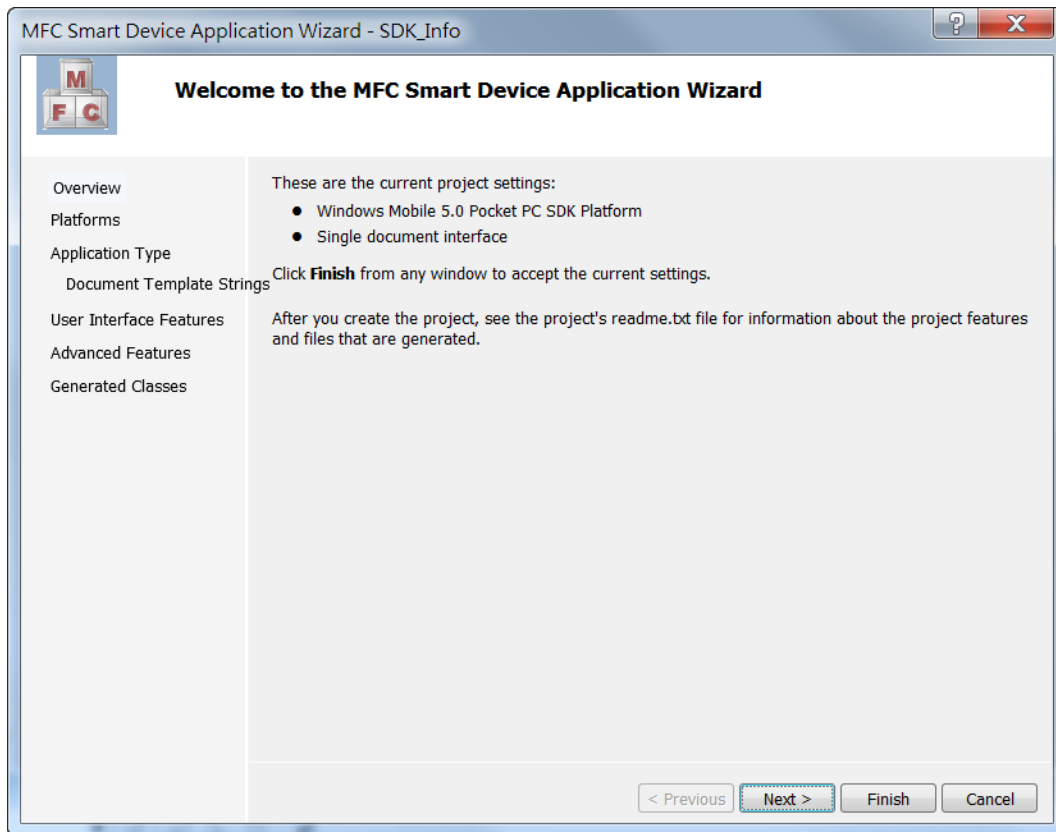

**Step 7: On the next page of the wizard, select AM335x\_WINCE7\_SDK to be added to the project, and then click Next**

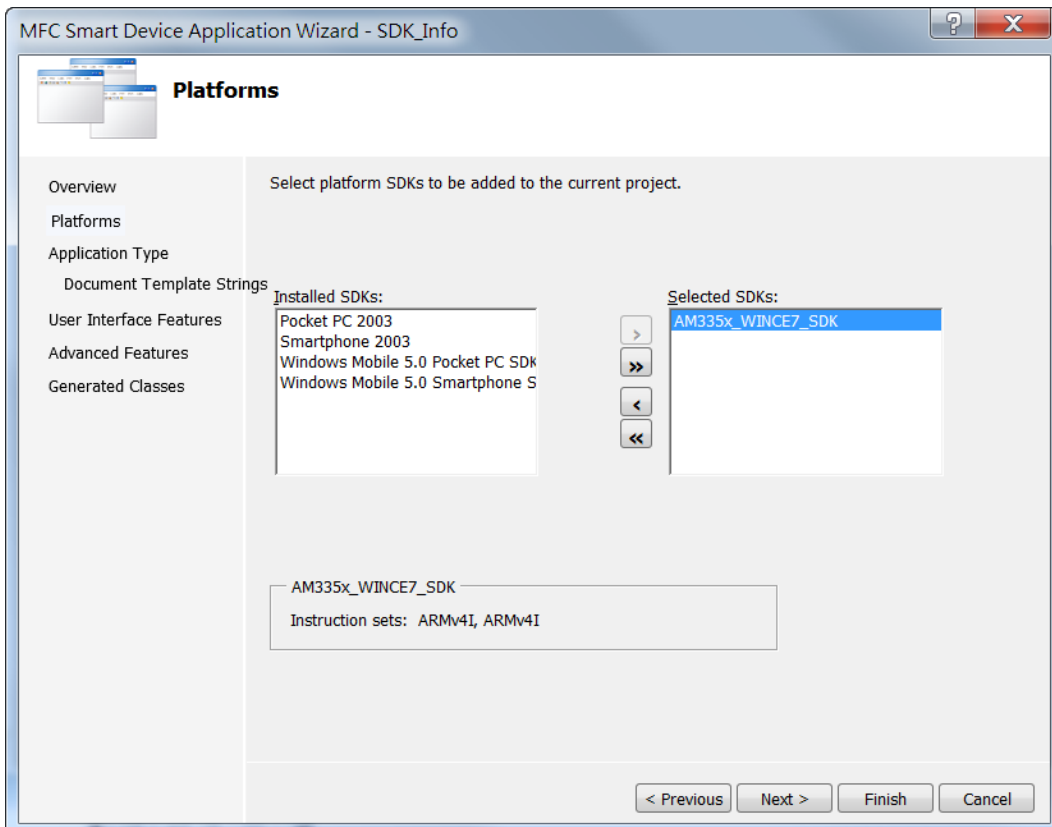

**Step 8: On the next page of the wizard, select Dialog based, and then click next**

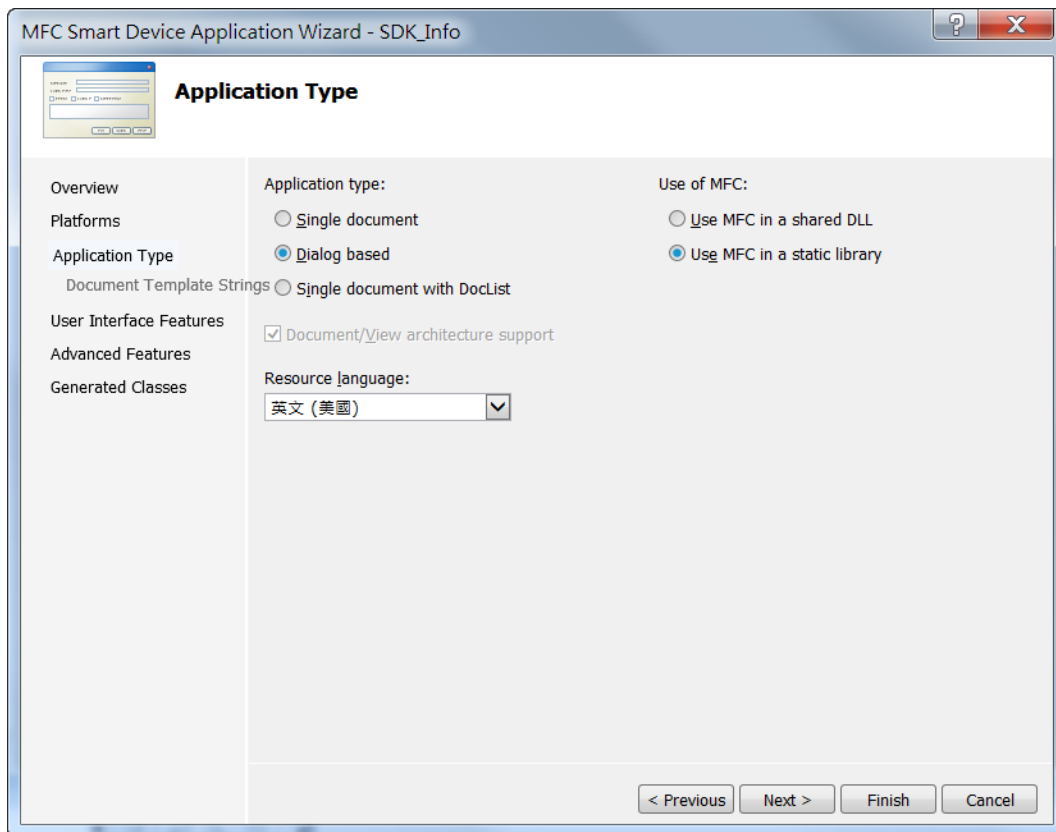

**Step 9: On the next page of the wizard, click next**

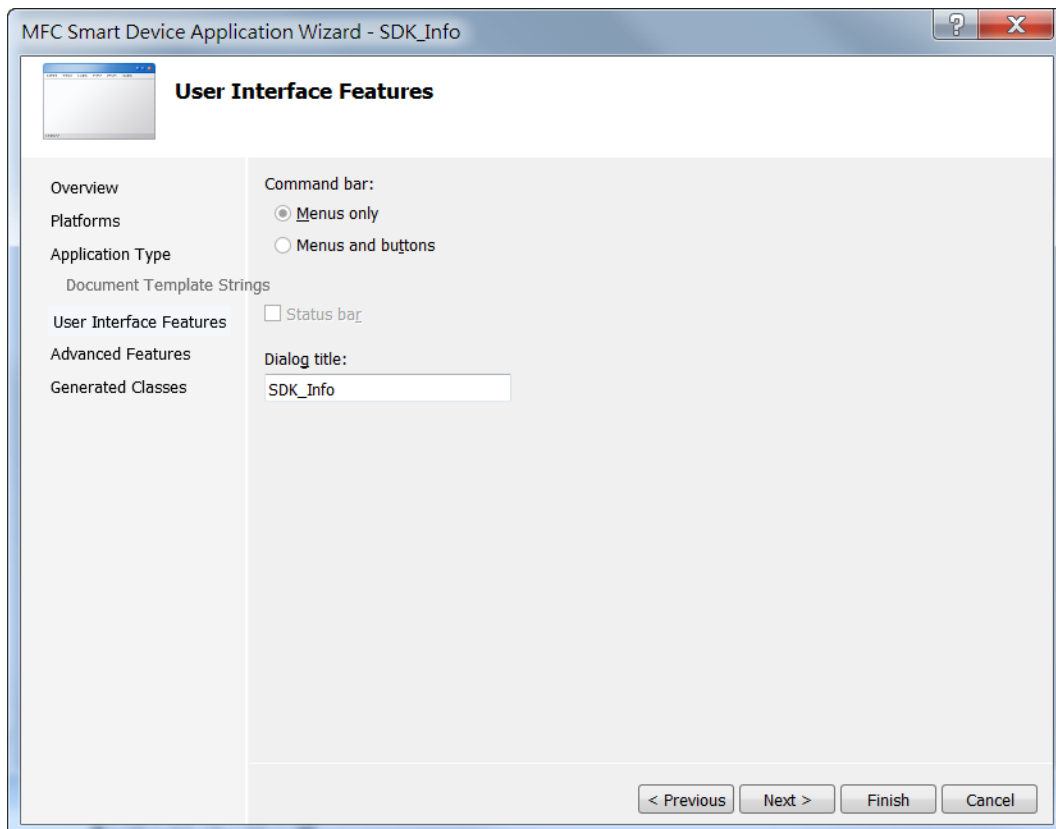

**Step 10: On the next page of the wizard, click next**

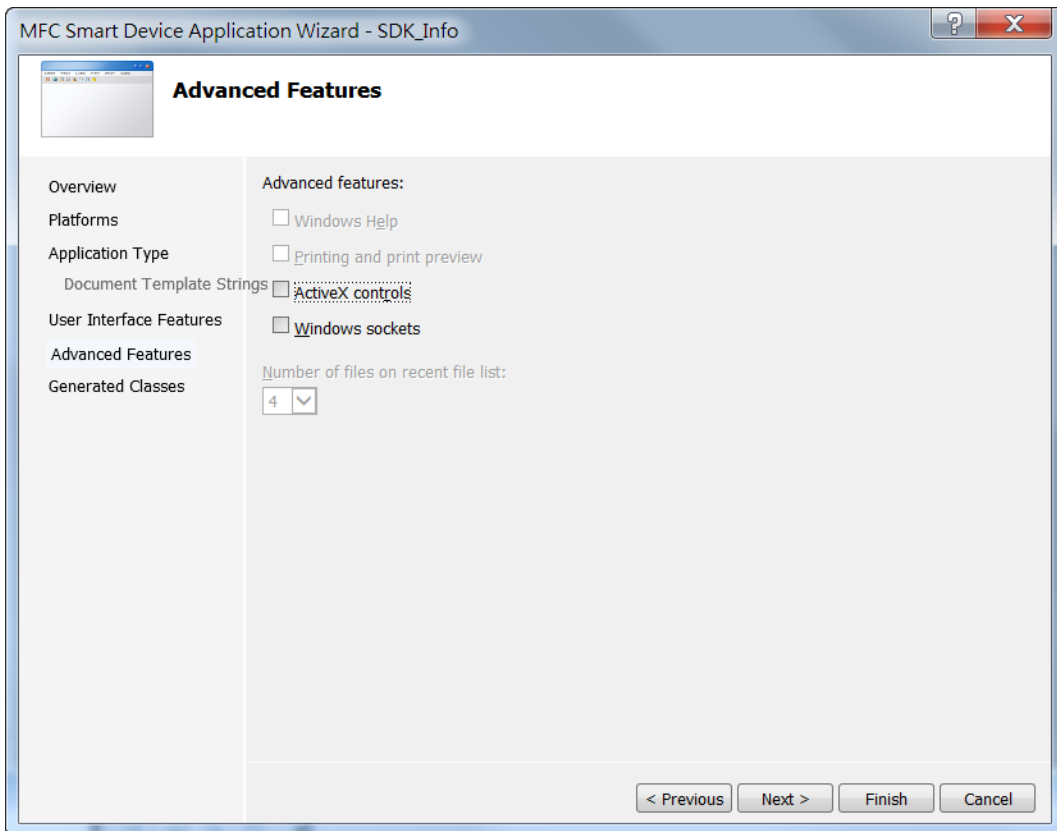

**Step 11: On the next page of the wizard, click Finish**

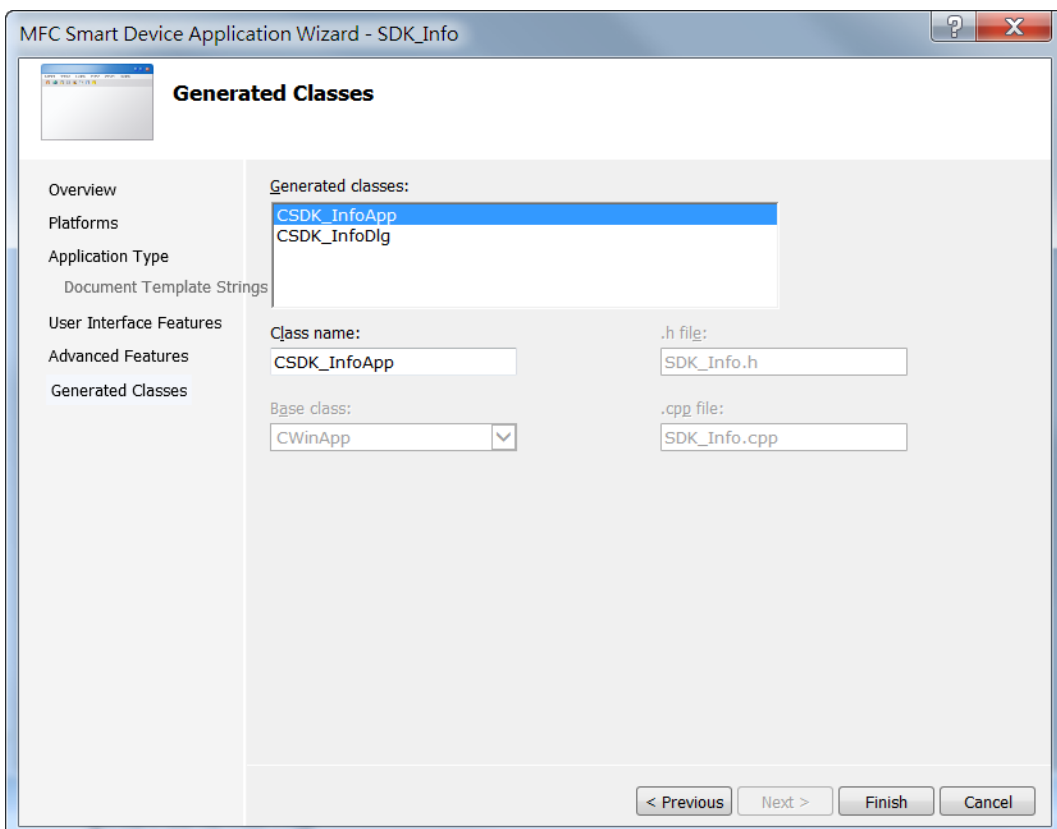



## 4.4.2. Configure the Platform

When developing applications by using Visual C++, you must configure the Platform to indicate what platform and device you intend to download the application to. Before you deploy your project, check the platform.

On the Debug configuration toolbar, select Release and select AM335x\_WINCE7\_SDK(ARMv4I) as shown in the following illustration.



### 4.4.3. Specify the Libraries of the PAC SDK

The PAC SDK provides the PACSDK libraries with WP-9000-CE7.

It's compatible with C++. In order to use a component in your application, you must first add a reference to it.

#### Step 1: On the View menu, and then click Property Pages

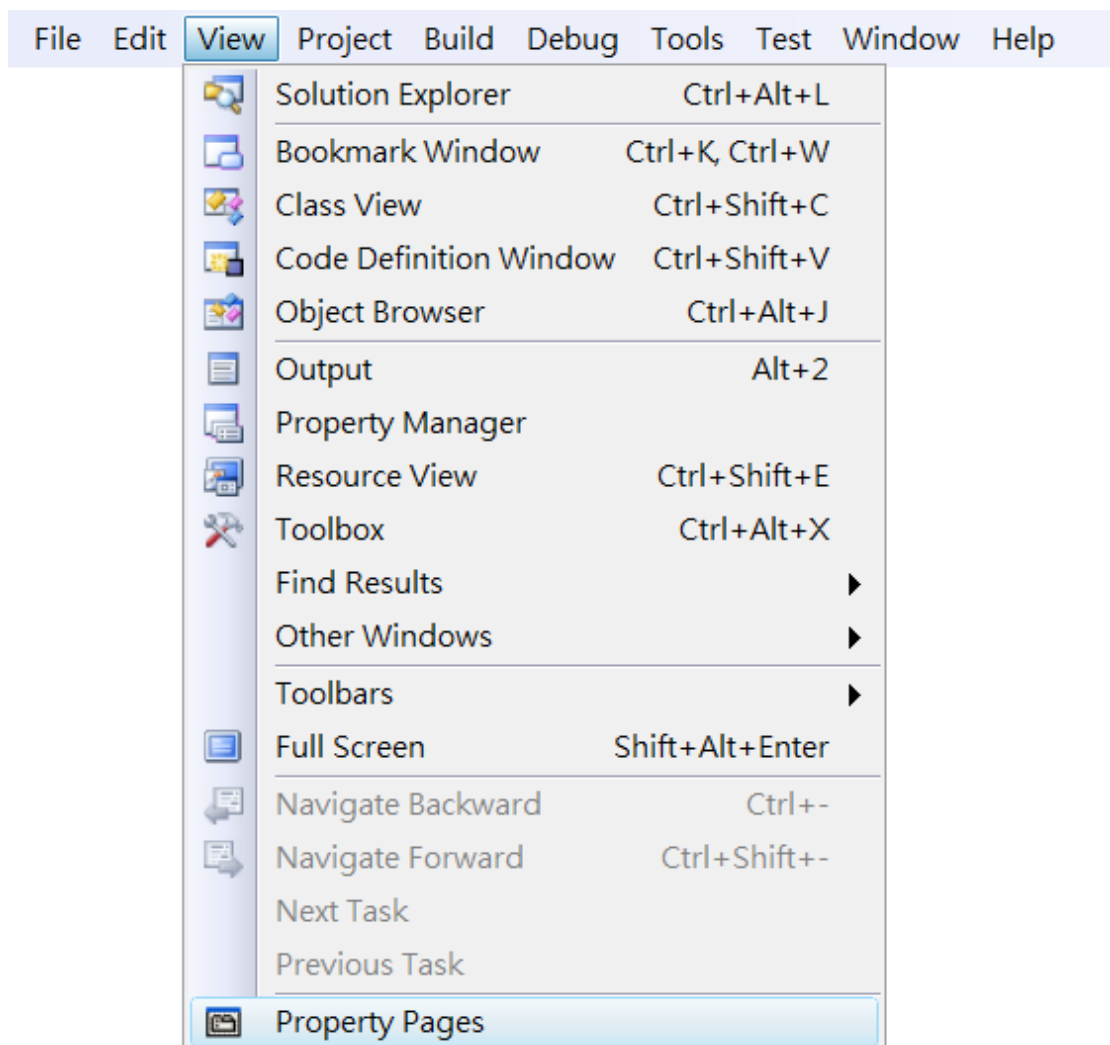

**Step 2: In left pane, click Linker, and then click Input**

**Step 3: In the right pane, Type PACSDK.lib in the Additional Dependencies item**

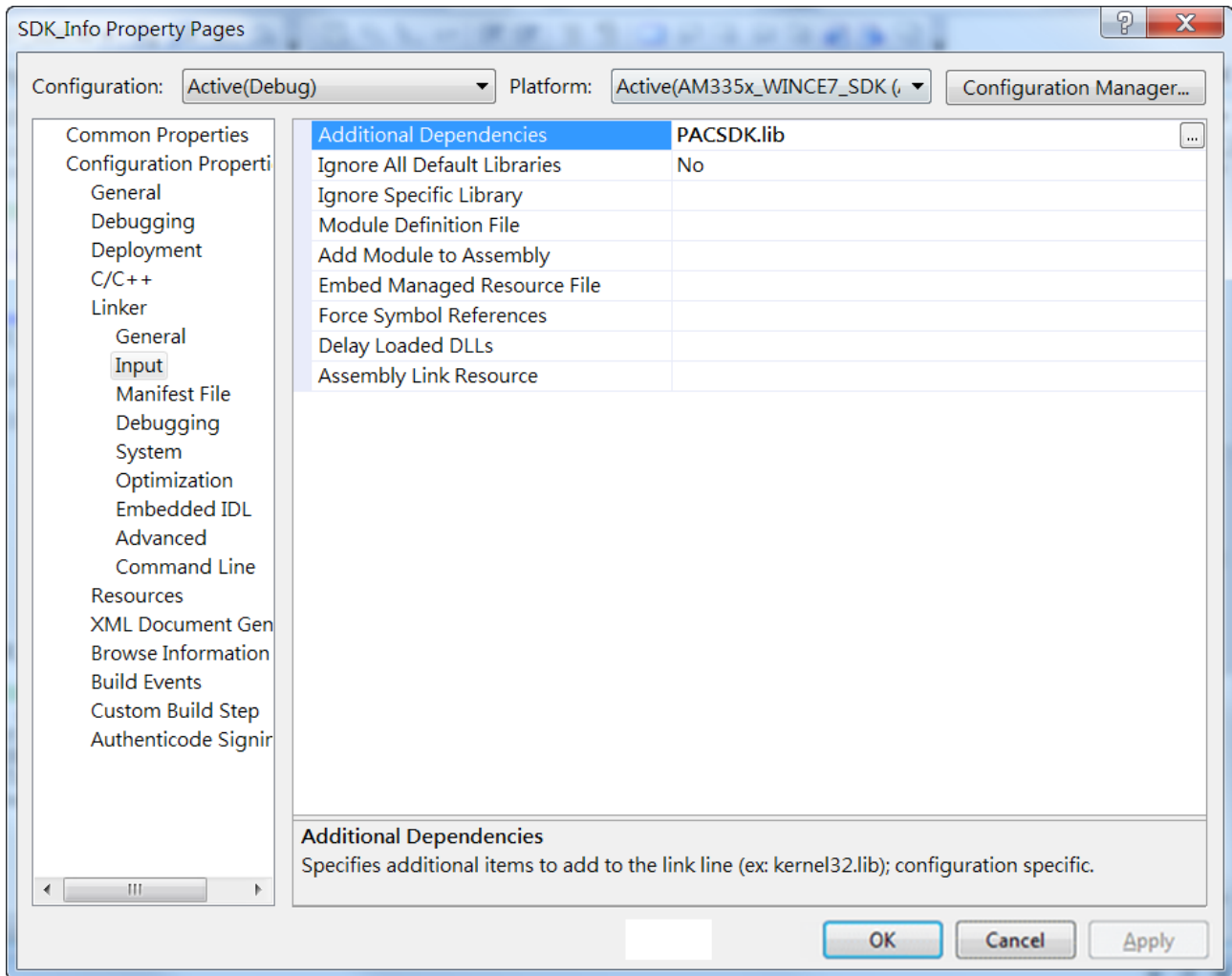

#### 4.4.4. Add the control to the form

You can drag various controls from the Toolbox onto the form. These controls are not really "live"; they are just images that are convenient to move around on the form into a precise location.

After you add a control to your form, you can use the Properties window to set its properties, such as background color and default text. The values that you specify in the Properties window are the initial values that will be assigned to that property when the control is created at run time.

##### Step 1: On the View menu, and then click Resource View

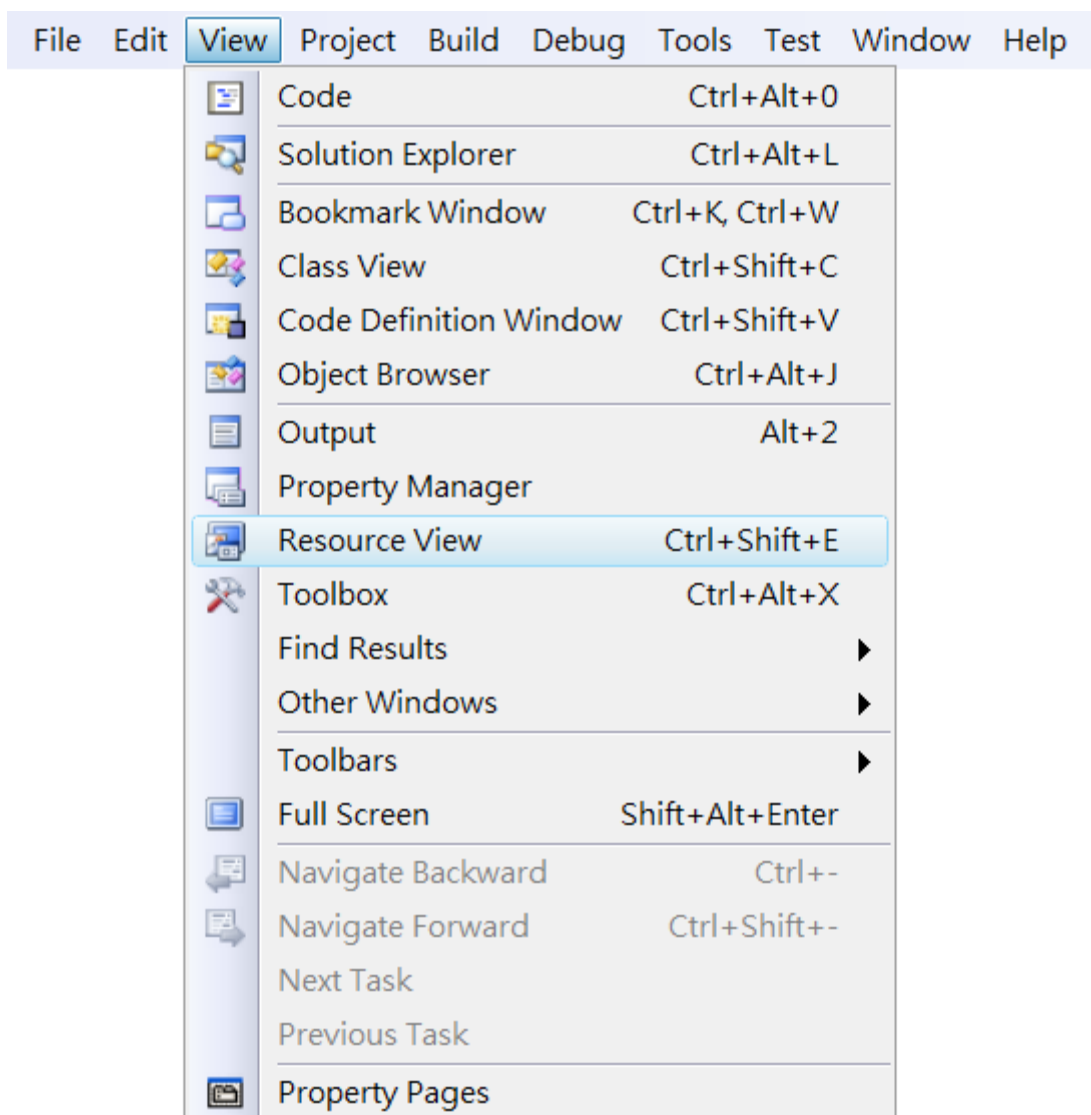

**Step 2: In the Resource View Panel, Expand the [Project name].rc file and then expand the Dialog item to click the plug-in dialog**

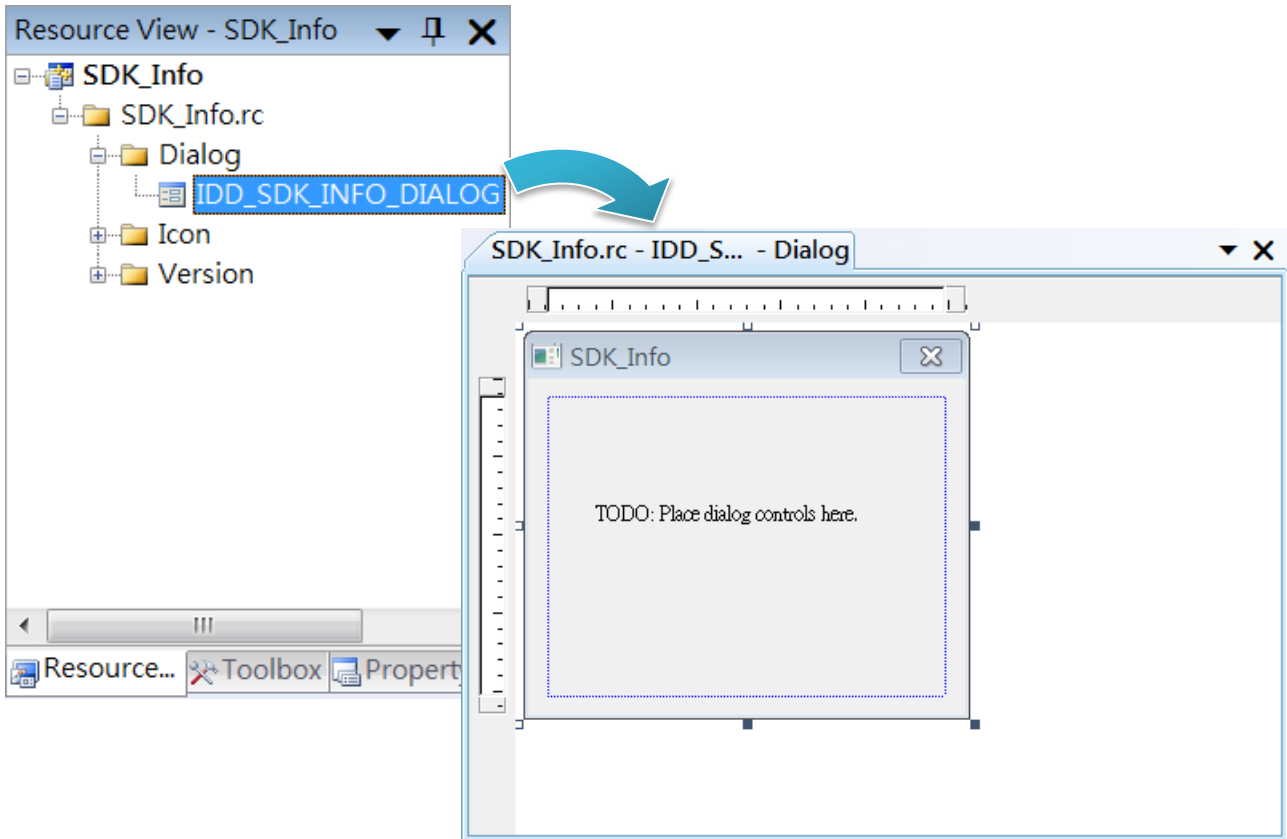

**Step 3: On the Toolbox panel, drag a Button control onto the form**

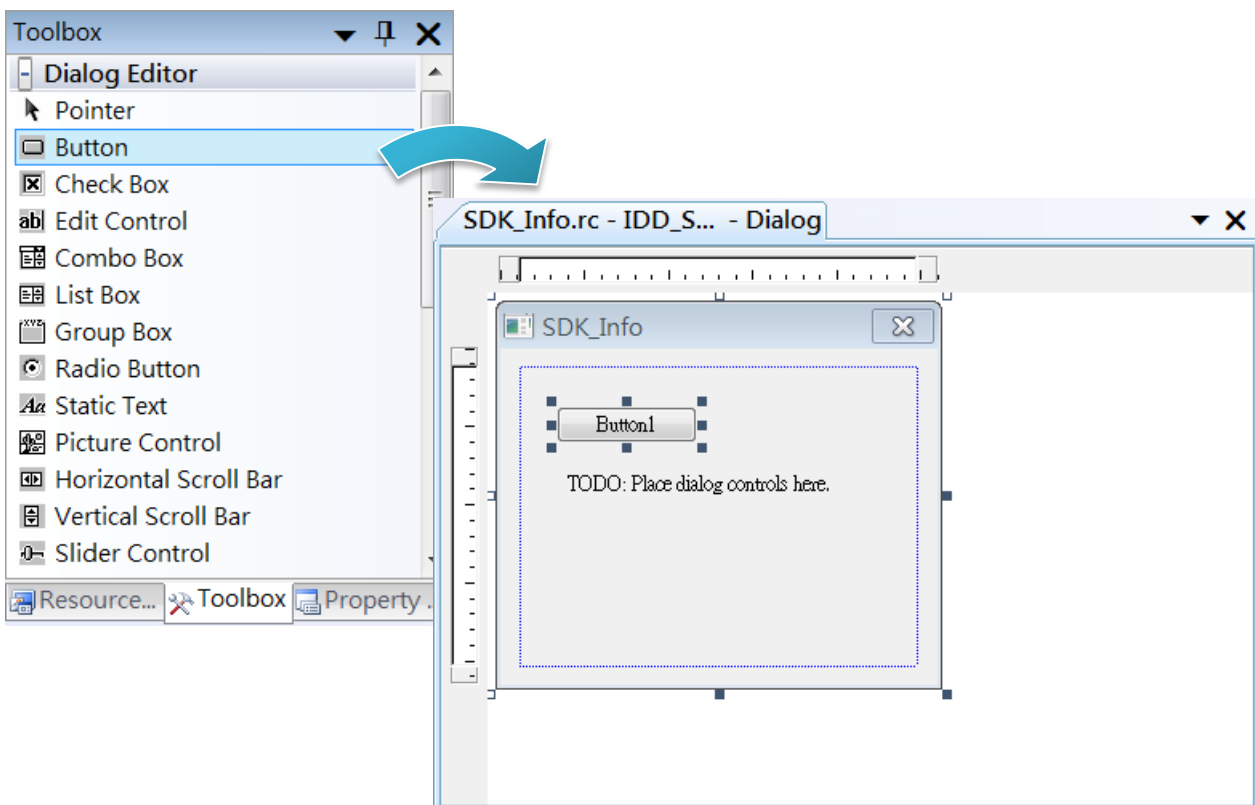

**Step 4: On the Properties panel, type Check the SDK version in the Caption field**

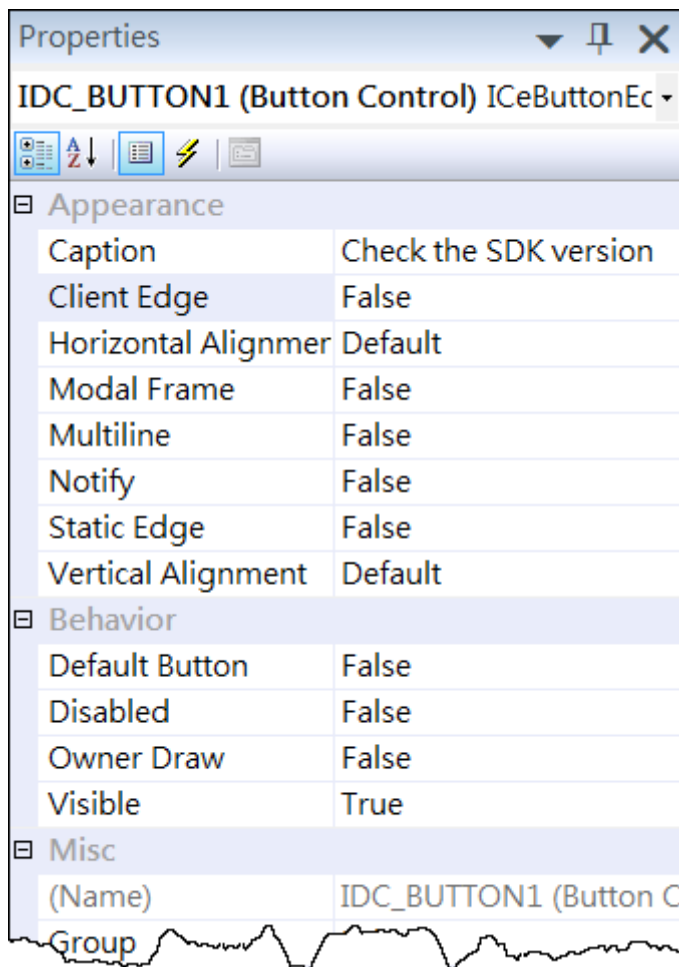

#### 4.4.5. Add the event handling for the control

You have finished the design stage of your application and are at the point when you can start adding some code to provide the program's functionality.

##### Step 1: Double-click the button on the form

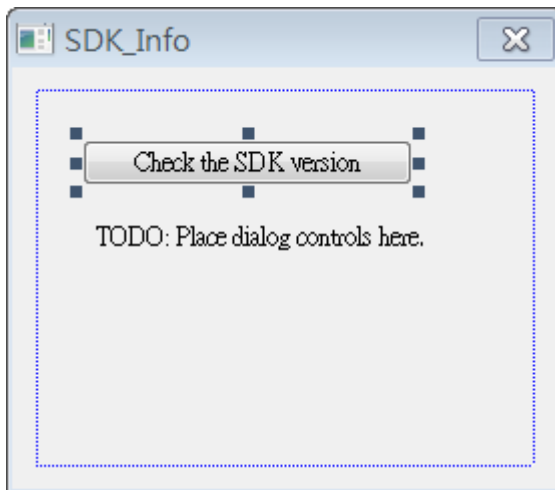

##### Step 2: Inserting the following code

```
char sdk_version[32];  
TCHAR buf[32];  
pac_GetSDKVersion(sdk_version);  
pac_AnsiToWideString(sdk_version, buf);  
MessageBox(buf,0,MB_OK);
```



**Step 2: Inserting the following code into the header area**

```
#include "PACSDK.h"
```

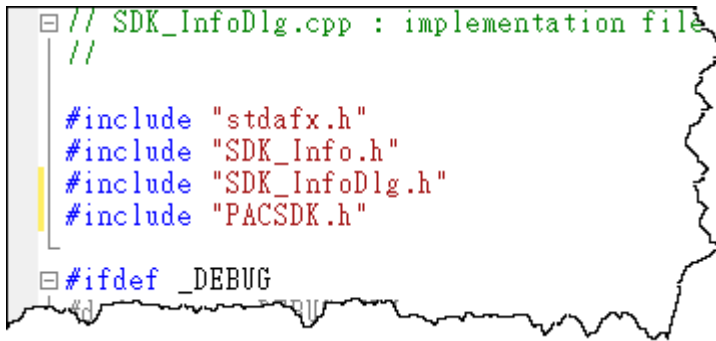

```
// SDK_InfoDlg.cpp : implementation file
//
#include "stdafx.h"
#include "SDK_Info.h"
#include "SDK_InfoDlg.h"
#include "PACSDK.h"
#ifdef _DEBUG
```



#### 4.4.6. Upload the application to WP-9000-CE7

WP-9000-CE7 supports FTP server service. You can upload files to WP-9000-CE7 or download files from a public FTP server.

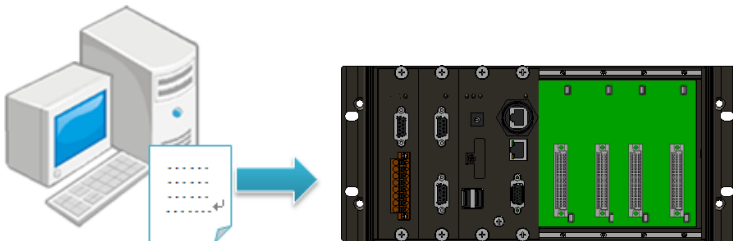

**Step 1: On the Build menu, and then click Build [Project Name]**

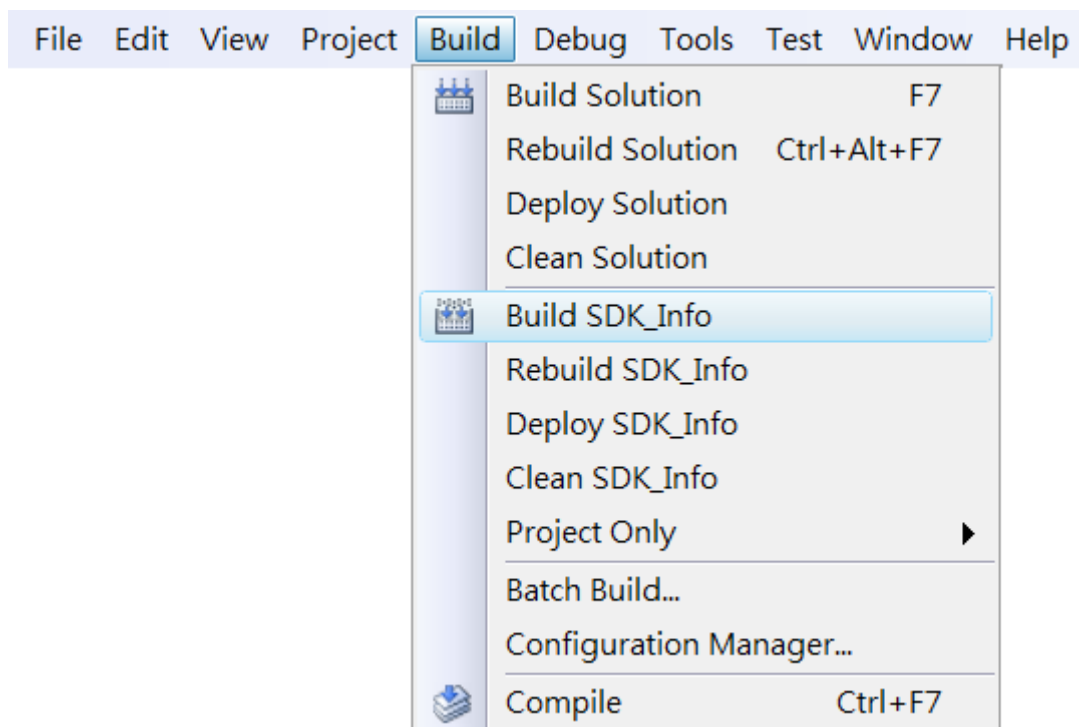

**Step 2: Open the browser and type the IP address of WP-9000-CE7**

**Step 3: Upload the application to WP-9000-CE7**

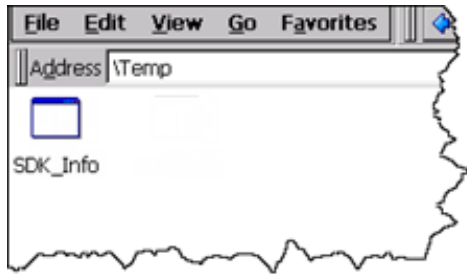

#### 4.4.7. Execute the application on WP-9000-CE7

After uploading the application to WP-9000-CE7, you can just double-click it on WP-9000-CE7 to execute it.

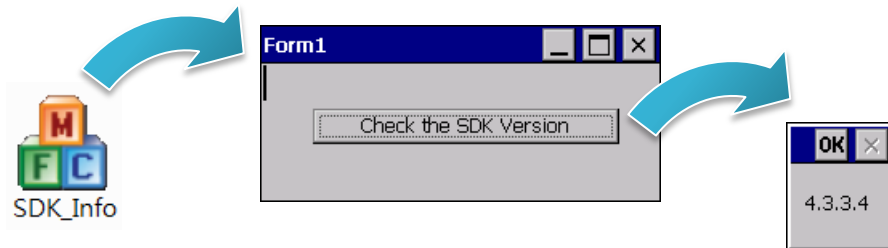

## 5. I/O Expansion Modules and SDKs Selection

This chapter describes how to select a suitable expansion I/O module and the corresponding SDK library to be used for developing programs on WP-9000-CE7.

WP-9000-CE7 provides the following I/O expansion buses:

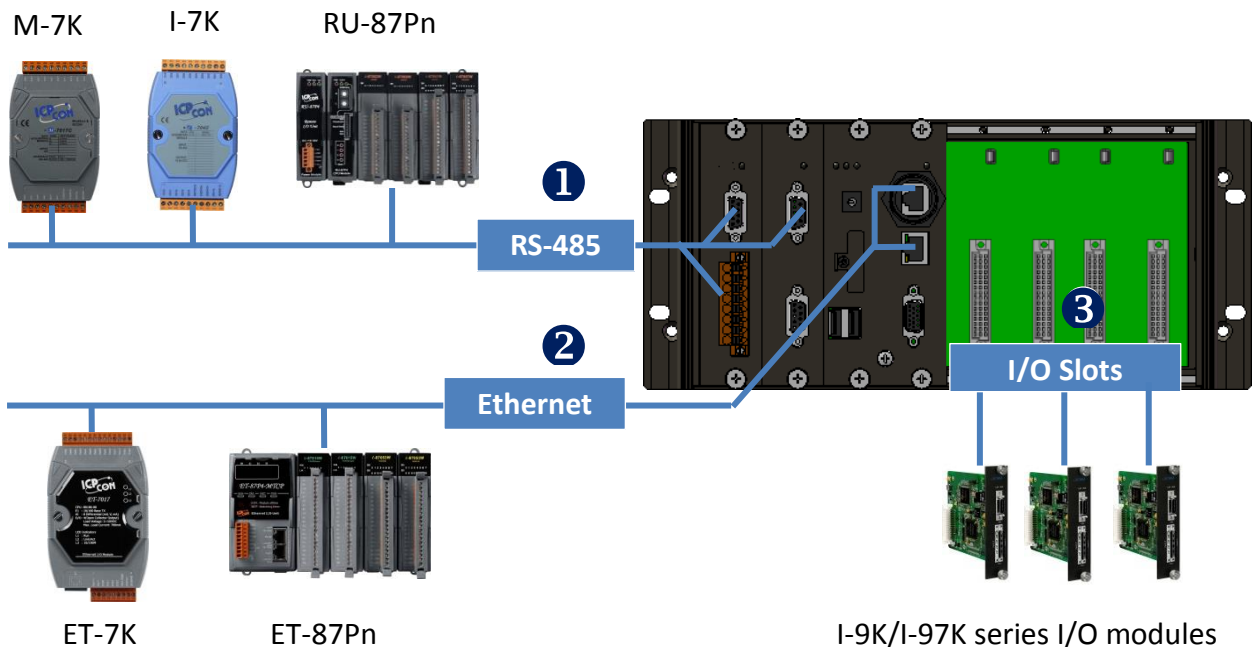

### RS-485 (I-7000 series and M-7000 series)

I-7000, M-7000, RU-87Pn and high profile I-87K series modules connect to WP-9000-CE7 via a twisted-pair, multi-drop, 2-wire RS-485 network.

#### ➤ I-7000 series I/O modules

Module	Native SDK	.NET CF SDK
I-7000 series	PACSDK.dll	PACNET.dll
I-7000 series with I-7088 (D)	PACSDK_PWM.dll	PACNET.dll

For full details regarding I-7000 series I/O modules and its demos, please refer to:

[http://ftp.icpdas.com/pub/cd/winpac\\_am335x/wp-9000/pac/applicable\\_demo\\_for\\_7k\\_module.pdf](http://ftp.icpdas.com/pub/cd/winpac_am335x/wp-9000/pac/applicable_demo_for_7k_module.pdf)

➤ **M-7000 series I/O modules**

Module	Native SDK	.NET CF SDK
M-7000 series	Modbus Demo	Modbus Demo

For more detailed information about M-7000 series modules using Modbus protocol and its demos, please refer to:

CD:\Wp-9000\demo\nModbus\

➤ **RU-87Pn + I-87K series I/O modules**

Module	Native SDK	.NET CF SDK
RU-87Pn+I-87K series	PACSDK.dll	PACNET.dll

➤ **Other Specified I/O**

Module	Native SDK	.NET CF SDK
Others	PACSDK.dll	PACNET.dll

**Ethernet (ET-7000 series and I-8KE4/8-MTCP)**

The Ethernet I/O devices available include ET-7000 and I-8KE4/8-MTCP, and support either the DCON or the Modbus/TCP communication protocol.

Module	Native SDK	.NET CF SDK
M-7000 series	Modbus Demo	Modbus Demo
I-8KE4/8-MTCP	Modbus Demo	Modbus Demo

For more detailed information about ET-7000 and I-8KE4/8-MTCP series modules using Modbus protocol and its demos, please refer to:

[http://ftp.icpdas.com/pub/cd/winpac\\_am335x/wp-9000/demo/nmodbus/](http://ftp.icpdas.com/pub/cd/winpac_am335x/wp-9000/demo/nmodbus/)

## 6. API Resources and Demo References

This chapter provides a brief overview of PAC standard APIs and demos that have been designed for WP-9000-CE7 from the PAC SDK package.

ICP DAS provides a set of demos in different programming languages. You can examine the demo codes, which includes numerous comments, to familiarize yourself with the PAC APIs. This will allow developing your own applications quickly by modifying these demo programs.

For full usage information regarding the description, prototype and the arguments of the functions, please refer to the “PAC Standard API Manual”

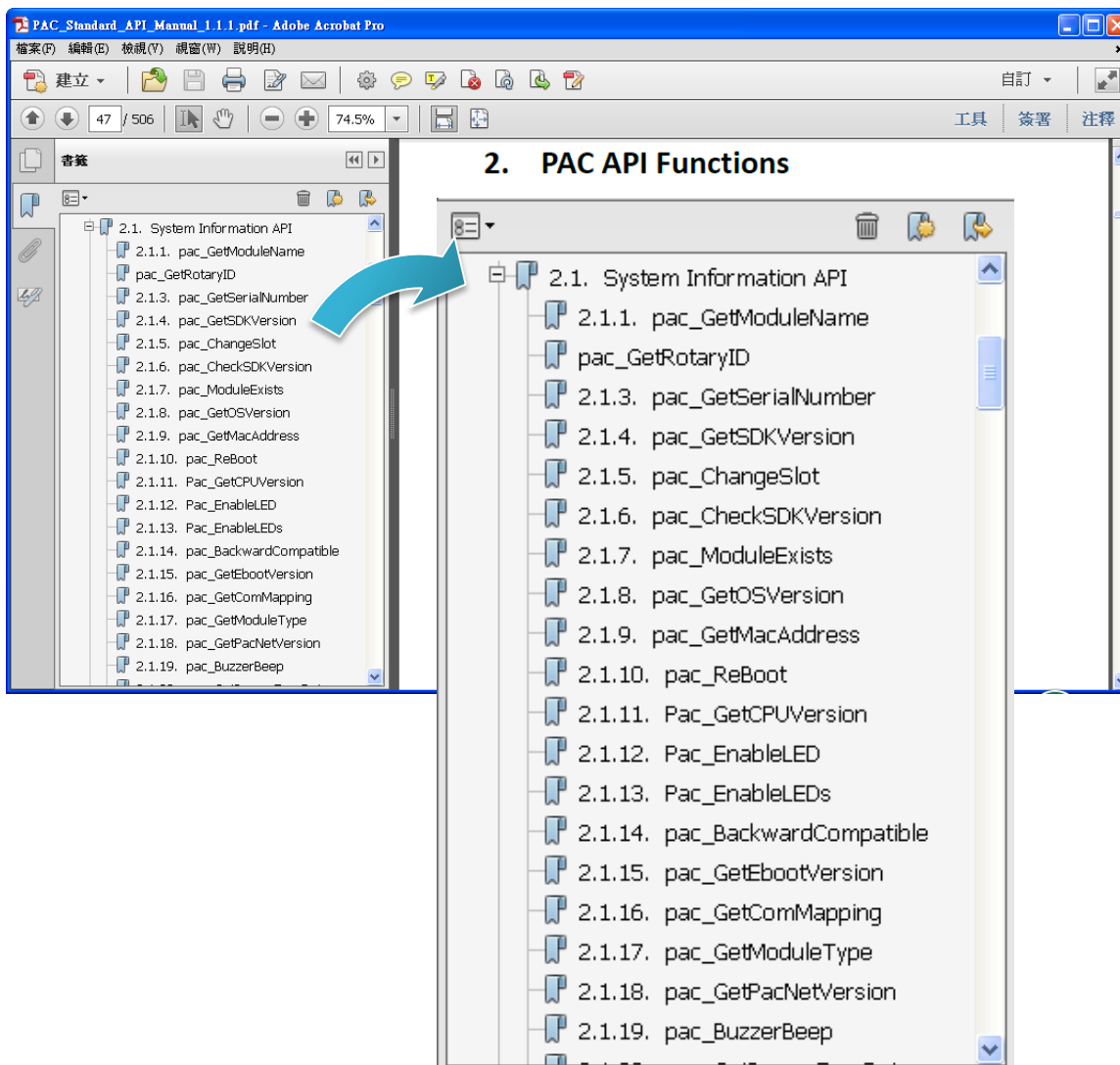

## 6.1. PAC Standard APIs for System Operation

The diagram below shows the set of each system operation API provided in the PACSDK.

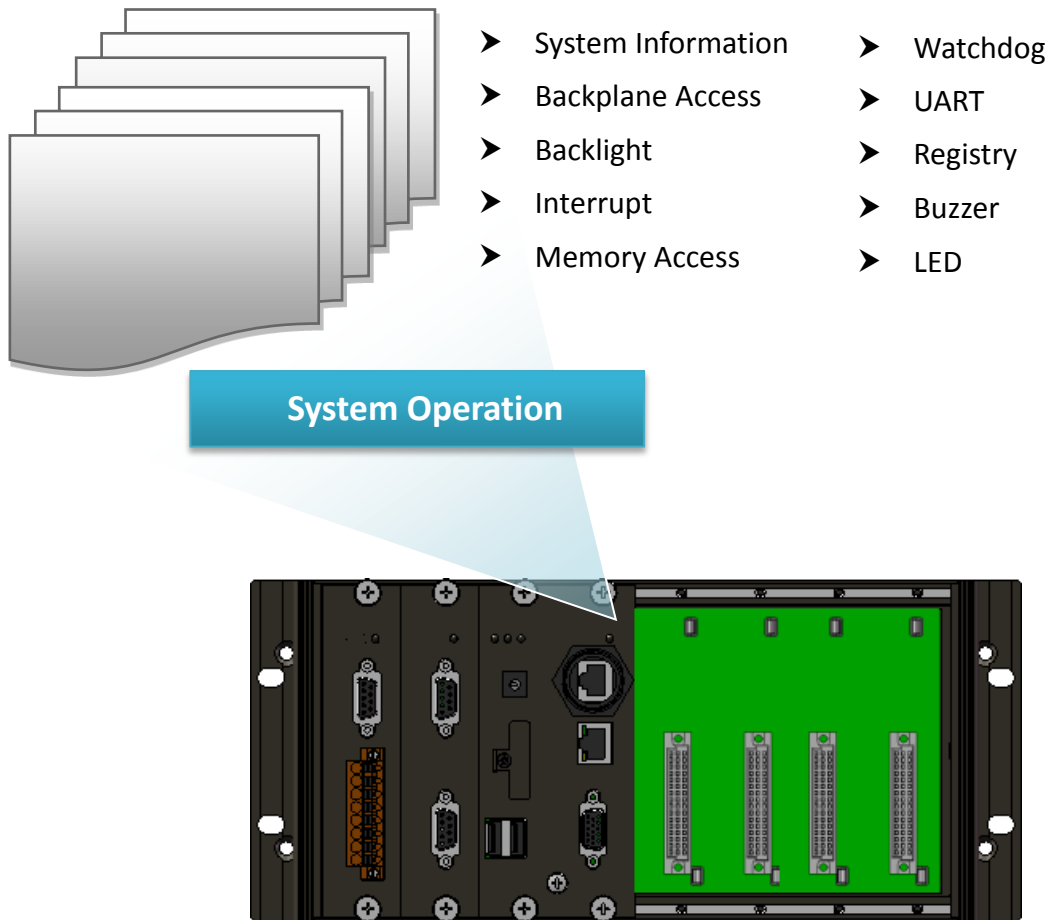

### 6.1.1. VB.NET Demos for PAC Standard APIs

The PAC SDK includes the following demos that demonstrate the use of the PAC Standard APIs in a VB.NET language environment.

The following demos can be found on the CD that was provided with the package or by downloading the latest version from ICP DAS web site.

CD:\WP-9000\Demo\PAC\Vb.net\Standard\

[http://ftp.icpdas.com/pub/cd/winpac\\_am335x/wp-9000/demo/pac/vb.net/standard/](http://ftp.icpdas.com/pub/cd/winpac_am335x/wp-9000/demo/pac/vb.net/standard/)

Folder	Demo	Explanation
buzzer	buzzer	Shows how to make a simple buzzer beep.
DeviceInformation	DeviceInformation	Retrieves information about the OS version, CPU version, SDK version, etc.
GetRotaryID	GetRotaryID	Retrieves information about the status of the rotary switch
Memory	Memory	Shows how to read/write data values from/to the EEPROM or the backplane of the SRAM
MultiRT	MultiRT	Shows how to manage the SD
RealTimeTest	RealTimeTest	Writes the managed cod for the rich graphical user interface that does not require true real-time performance
Registry	Registry	Shows how to read/write data values from/to the registry
UART	UART	Shows how to read the name of a local I/O modules via a UART
WatchDog	WatchDog	Displays information about how to operate the watchdog



## 6.1.2. C# Demos for PAC Standard APIs

The PAC SDK includes the following demos that demonstrate the use of the PAC Standard APIs in a C# language environment.

The following demos can be found on the CD that was provided with the package or by downloading the latest version from ICP DAS web site.

CD:\WP-9000\Demo\PAC\C#\Standard\

[http://ftp.icpdas.com/pub/cd/winpac\\_am335x/wp-9000/demo/pac/c%23/standard/](http://ftp.icpdas.com/pub/cd/winpac_am335x/wp-9000/demo/pac/c%23/standard/)

Folder	Demo	Explanation
buzzer	buzzer	Shows how to make a simple buzzer beep.
DeviceInformation	DeviceInformation	Retrieves information about the OS version, CPU version, SDK version, etc.
GetRotaryID	GetRotaryID	Retrieves information about the status of the rotary switch
Memory	Memory	Shows how to read/write data values from/to the EEPROM or the backplane of the SRAM
MultiRT	MultiRT	Shows how to manage the SD
RealTimeTest	RealTimeTest	Writes the managed cod for the rich graphical user interface that does not require true real-time performance
Registry	Registry	Shows how to read/write data values from/to the registry
UART	UART	Shows how to read the name of a local I/O modules via a UART
WatchDog	WatchDog	Displays information about how to operate the watchdog

### 6.1.3. Visual C++ Demos for PAC Standard APIs

The PAC SDK includes the following demos that demonstrate the use of the PAC Standard APIs in a Visual C++ language environment.

The following demos can be found on the CD that was provided with the package or by downloading the latest version from ICP DAS web site.

CD:\WP-9000\Demo\PAC\Vc2008\Standard\

[http://ftp.icpdas.com/pub/cd/winpac\\_am335x/wp-9000/demo/pac/vc2008/standard/](http://ftp.icpdas.com/pub/cd/winpac_am335x/wp-9000/demo/pac/vc2008/standard/)

Folder	Demo	Explanation
buzzer	buzzer	Shows how to make a simple buzzer beep.
DeviceInformation	DeviceInformation	Retrieves information about the OS version, CPU version, SDK version, etc.
GetRotaryID	GetRotaryID	Retrieves information about the status of the rotary switch
Memory	Memory	Shows how to read/write data values from/to the EEPROM or the backplane of the SRAM
MultiRT	MultiRT	Shows how to manage the SD
RealTimeTest	RealTimeTest	Writes the managed cod for the rich graphical user interface that does not require true real-time performance
Registry	Registry	Shows how to read/write data values from/to the registry
UART	UART	Shows how to read the name of a local I/O modules via a UART
WatchDog	WatchDog	Displays information about how to operate the watchdog

## 6.2. PAC Standard APIs for PAC Expansion I/O

The diagram below shows the types of the PAC IO APIs provided in the PACSDK.

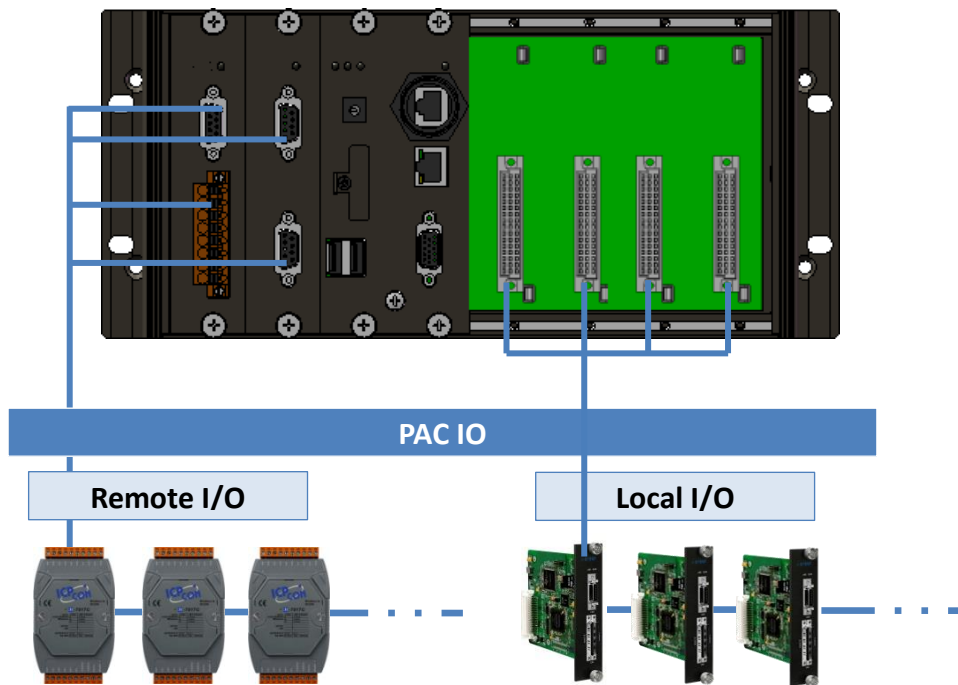

## 6.2.1. VB.NET Demos for PAC Expansion I/O

The PAC SDK includes the following demos that demonstrate the use of the PAC expansion I/O in a VB.NET language environment.

The following demos can be found on the CD that was provided with the package or by downloading the latest version from ICP DAS web site.

CD:\WP-9000\Demo\PAC\Vb.net\IO\

[http://ftp.icpdas.com/pub/cd/winpac\\_am335x/wp-9000/demo/pac/vb.net/io/](http://ftp.icpdas.com/pub/cd/winpac_am335x/wp-9000/demo/pac/vb.net/io/)

Folder	Demo	Explanation
Remote	7k87k_basic	Shows how to send/receive a command/response application. This demo program is used by 7K or 87K series AI modules which connected through a COM port.
	7k87k_ai	Shows how to read the AI values of AI module. This demo program is used by 7K or 87K series AI modules which connected through a COM port.
	7k87k_ao	Shows how to write the AO values to AO module. This demo program is used by 7K or 87K series AI modules which connected through a COM port.
	7k87k_di	Shows how to read the DI values of DI module. This demo program is used by 7K or 87K series AI modules which connected through a COM port.
	7k87k_do	Shows how to write the DO values to DO module. This demo program is used by 7K or 87K series AI modules which connected through a COM port.
	7k87k_dio	Shows how to read the DI and the DO values of the DIO module. This demo program is used by 7K or 87K series AI modules which connected through a COM port.

## 6.2.2. C# Demos for PAC Expansion I/O

The PAC SDK includes the following demos that demonstrate the use of the PAC expansion I/O in a C# language environment.

The following demos can be found on the CD that was provided with the package or by downloading the latest version from ICP DAS web site.

CD:\WP-9000\Demo\PAC\C#\IO\

[http://ftp.icpdas.com/pub/cd/winpac\\_am335x/wp-9000/demo/pac/c%23/io/](http://ftp.icpdas.com/pub/cd/winpac_am335x/wp-9000/demo/pac/c%23/io/)

Folder	Demo	Explanation
Remote	7k87k_basic	Shows how to send/receive a command/response application. This demo program is used by 7K or 87K series AI modules which connected through a COM port.
	7k87k_ai	Shows how to read the AI values of AI module. This demo program is used by 7K or 87K series AI modules which connected through a COM port.
	7k87k_ao	Shows how to write the AO values to AO module. This demo program is used by 7K or 87K series AI modules which connected through a COM port.
	7k87k_di	Shows how to read the DI values of DI module. This demo program is used by 7K or 87K series AI modules which connected through a COM port.
	7k87k_do	Shows how to write the DO values to DO module. This demo program is used by 7K or 87K series AI modules which connected through a COM port.
	7k87k_dio	Shows how to read the DI and the DO values of the DIO module. This demo program is used by 7K or 87K series AI modules which connected through a COM port.

### 6.2.3. Visual C++ Demos for PAC Expansion I/O

The PAC SDK includes the following demos that demonstrate the use of the PAC expansion I/O in a C# language environment.

The following demos can be found on the CD that was provided with the package or by downloading the latest version from ICP DAS web site.

CD:\WP-9000\Demo\PAC\Vc2008\IO\

[http://ftp.icpdas.com/pub/cd/winpac\\_am335x/wp-9000/demo/pac/vc2008/io/](http://ftp.icpdas.com/pub/cd/winpac_am335x/wp-9000/demo/pac/vc2008/io/)

Folder	Demo	Explanation
Remote	7k87k_basic	Shows how to send/receive a command/response application. This demo program is used by 7K or 87K series AI modules which connected through a COM port.
	7k87k_ai	Shows how to read the AI values of AI module. This demo program is used by 7K or 87K series AI modules which connected through a COM port.
	7k87k_ao	Shows how to write the AO values to AO module. This demo program is used by 7K or 87K series AI modules which connected through a COM port.
	7k87k_di	Shows how to read the DI values of DI module. This demo program is used by 7K or 87K series AI modules which connected through a COM port.
	7k87k_do	Shows how to write the DO values to DO module. This demo program is used by 7K or 87K series AI modules which connected through a COM port.
	7k87k_dio	Shows how to read the DI and the DO values of the DIO module. This demo program is used by 7K or 87K series AI modules which connected through a COM port.

## 7. WP-9000-CE7 Updates

This chapter provides a guided tour that demonstrates the steps needed to update the WP-9000-CE7 OS and SDKs.

ICP DAS will continue to add additional features to WP-9000-CE7 SDK and OS in the future, so we advise you to periodically check the ICP DAS web site for the latest updates.

The file location of the OS and SDK

Both the files of OS updates and SDK updates can be found on the CD that was provided with the package or by downloading the latest version from ICP DAS web site.

CD:\wp-9000\

[http://ftp.icpdas.com/pub/cd/winpac\\_am335x/wp-9000/](http://ftp.icpdas.com/pub/cd/winpac_am335x/wp-9000/)

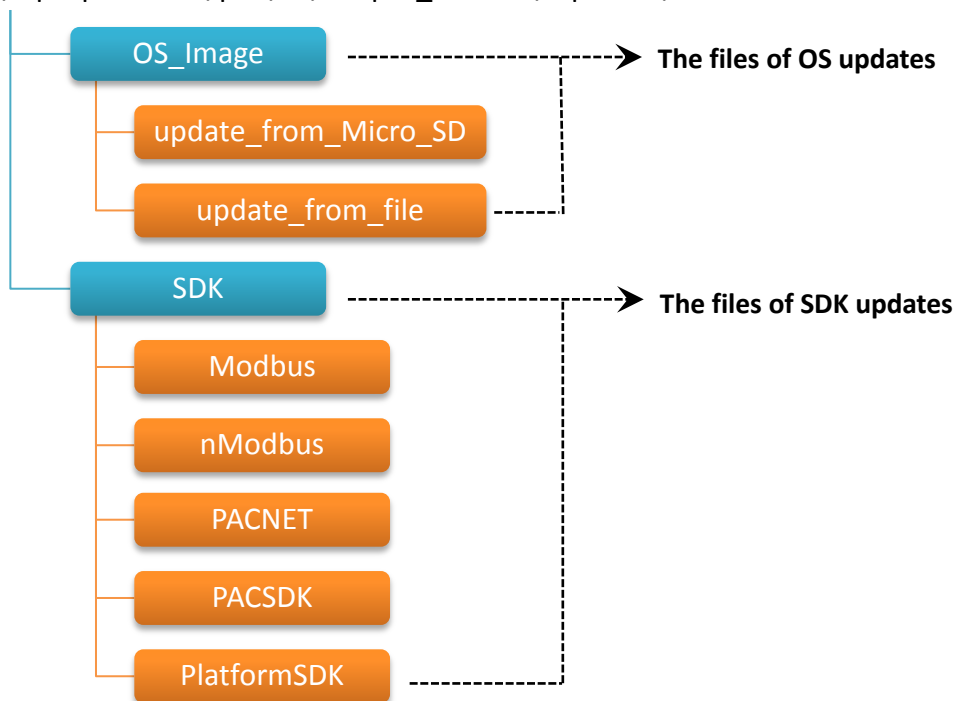

## 7.1. OS Updates

The latest version of the WP-9000-CE7 OS image can be found separately on the CD that was provided with the package or by downloading the latest version from ICP DAS web site.

CD:\wp-9000\OS\_Image\  
http://ftp.icpdas.com/pub/cd/winpac\_am335x/wp-9000/os\_image/

[http://ftp.icpdas.com/pub/cd/winpac\\_am335x/wp-9000/os\\_image/](http://ftp.icpdas.com/pub/cd/winpac_am335x/wp-9000/os_image/)



There are two ways to update the OS:

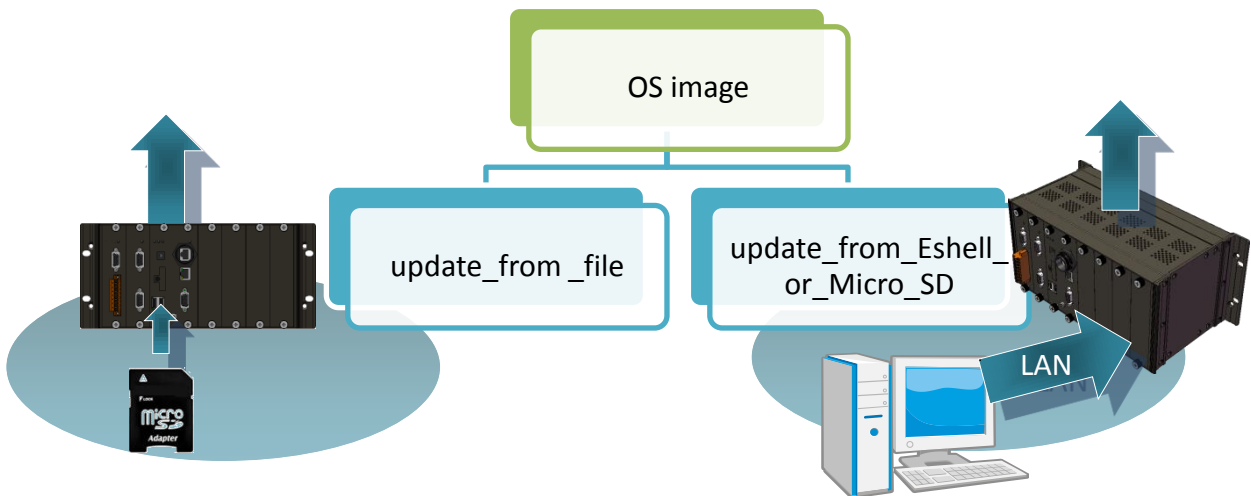

1. OS updates from Eshell (Please refer to section 7.1.1)  
(We recommend that you use this one for more quicker and easier to update)
2. OS updates from SD (Please refer to section 7.1.2)



### 7.1.1. OS Updates from Eshell

By default, the OS update is updated via a LAN.  
Before updating the OS, make sure the LAN is connected to PC.

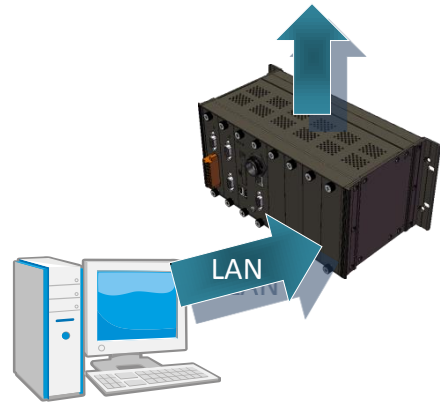

#### Step 1: Get the latest version of the installation package file and then unzip it

The latest version of the installation package file can be found from ICP DAS web site.

[http://ftp.icpdas.com/pub/cd/winpac\\_am335x/WP-9000-CE7/os\\_image/update\\_from\\_eshell\\_or\\_micro\\_sd/](http://ftp.icpdas.com/pub/cd/winpac_am335x/WP-9000-CE7/os_image/update_from_eshell_or_micro_sd/)

#### Step 2: Run the registry clear.exe

The registry.exe can be found on the CD that was provided with the package or by downloading the latest version from ICP DAS web site.

CD:\WP-9000\PC\_Tools\Eshell

[http://ftp.icpdas.com/pub/cd/winpac\\_am335x/WP-9000-CE7/pc\\_tools/eshell](http://ftp.icpdas.com/pub/cd/winpac_am335x/WP-9000-CE7/pc_tools/eshell)

#### Step 3: Place the rotary switch in position 3, OS update mode

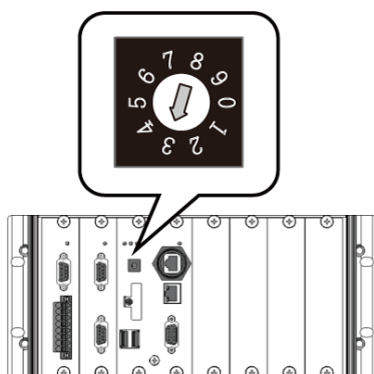

#### Step 4: Run the ESHELL.exe, and then restart the WP-9000-CE7-CE7

The ESHELL.exe can be found on the CD that was provided with the package or by downloading the latest version from ICP DAS web site.



CD:\WP-9000\PC\_Tools\Eshell

[http://ftp.icpdas.com/pub/cd/winpac\\_am335x/wp-9000/pc\\_tools/eshell](http://ftp.icpdas.com/pub/cd/winpac_am335x/wp-9000/pc_tools/eshell)

#### Step 5: Select the device which you want to update the OS image, and then click OK

Select the device name which you want to update the OS image from the list.

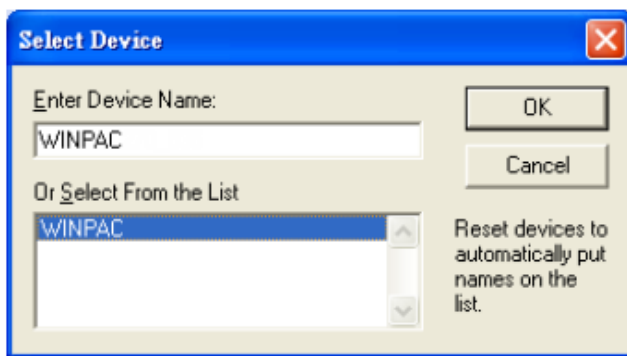

#### Step 6: Select the latest version of the OS image file

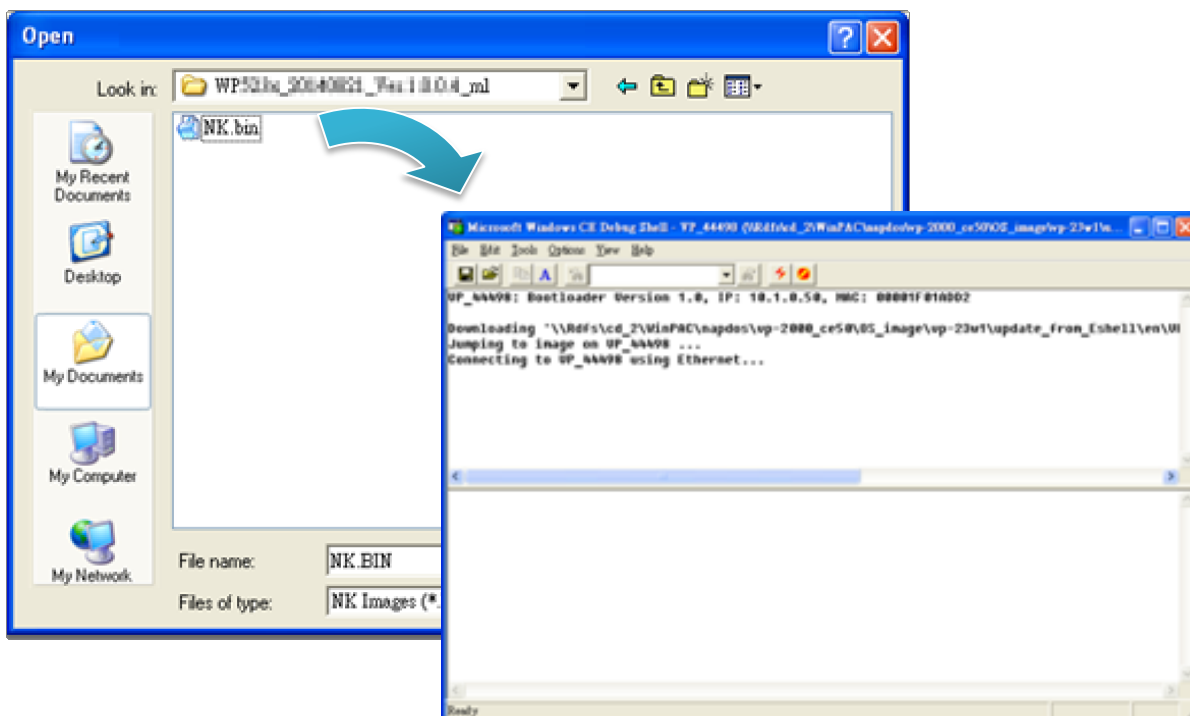

**Step 7: Once the procedure is completed, the “Warning !” dialog box will appear as below shown, then turn the rotary switch in position 0, normal mode**

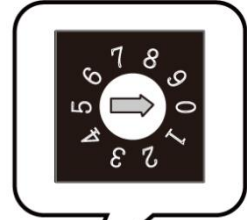
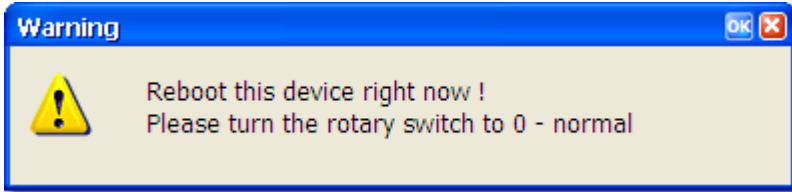

**Step 8: Click the OK button**

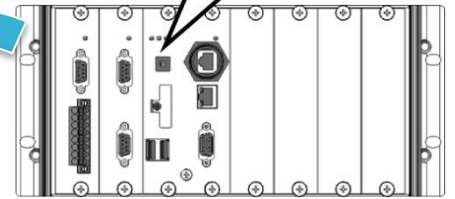
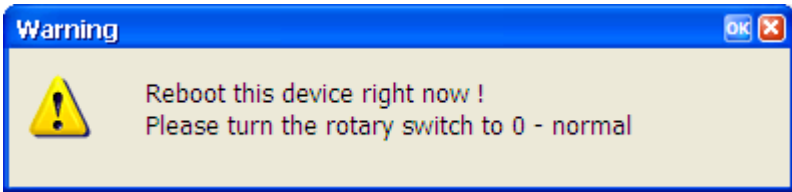

**Step 9: Check the OS version**

Run the PAC Utility, and then select the Device Information tab to check the current OS version.

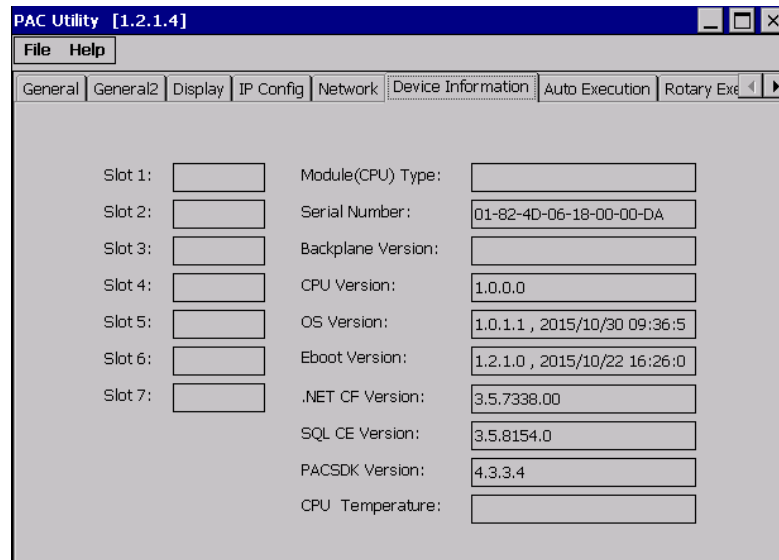

### 7.1.2. OS updates using SD

The SD card can be used to reinstall the WP-9000-CE7 OS image to factory default settings in the event of the WP-9000-CE7 failure.

#### Step 1: Get the latest version of the installation package file, then unzip the file, and then copy them to SD card

The latest version of the installation package file can be found from ICP DAS web site.

[http://ftp.icpdas.com/pub/cd/winpac\\_am335x/wp-9000/os\\_image/update\\_from\\_eshell\\_or\\_micro\\_sd](http://ftp.icpdas.com/pub/cd/winpac_am335x/wp-9000/os_image/update_from_eshell_or_micro_sd)

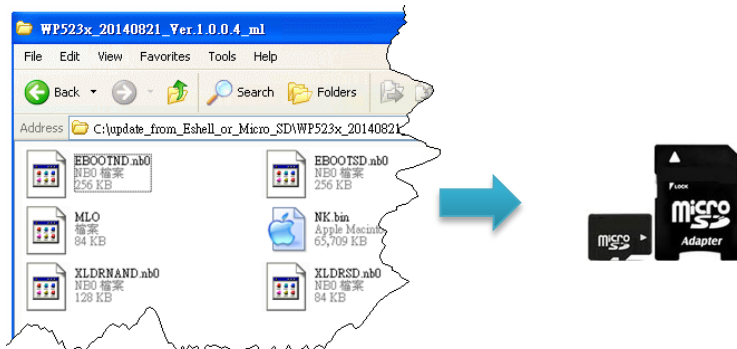

#### Step 2: Plug the SD card into SD slot

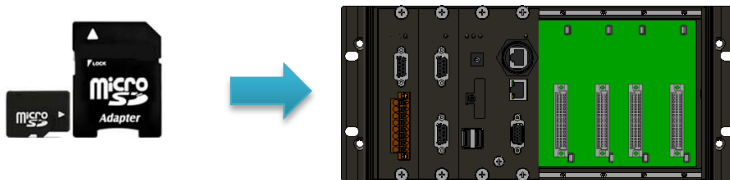

**Step 3: Turn the rotary switch in position 5, OS update mode**

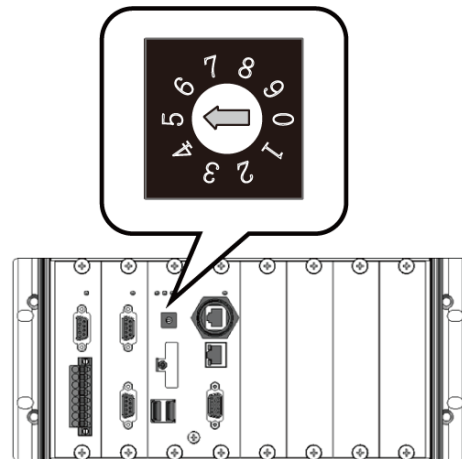

**Step 4: Reboot the WP-9000-CE7**

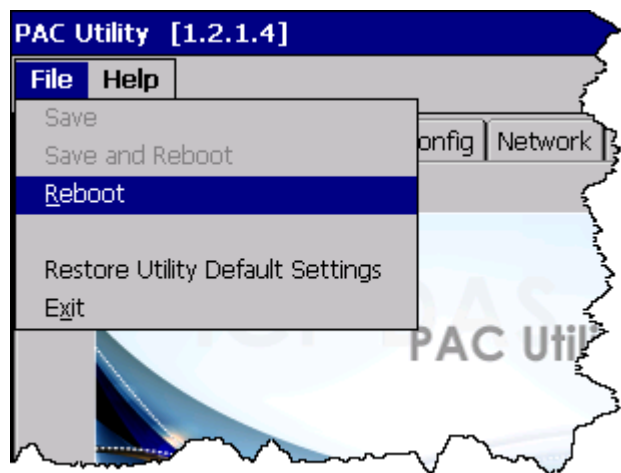

**Step 5: Wait a few minutes for the following desktop to be displayed**



**Step 6: Turn the rotary switch in position 0, normal mode**

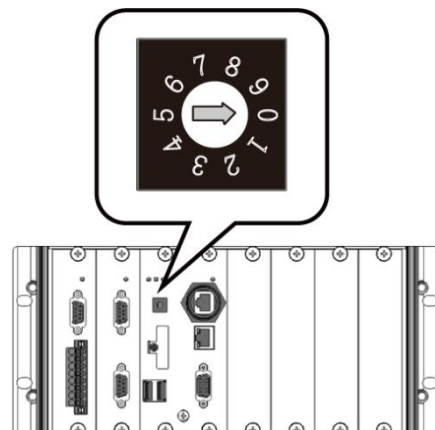

### Step 7: Reboot the WP-9000-CE7

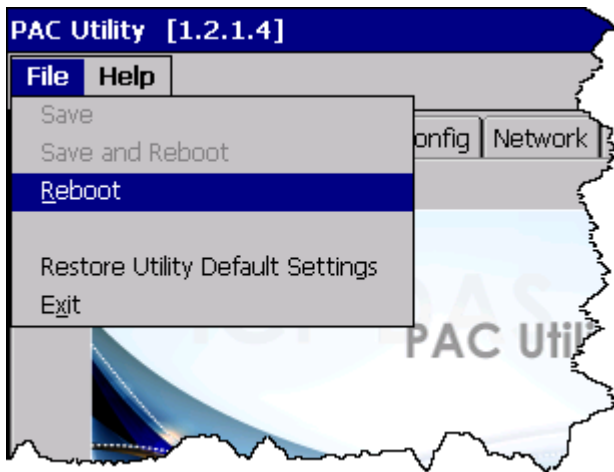

### Step 8: Check the OS version

Run the PAC Utility, and then select the Device Information tab to check the current OS version.

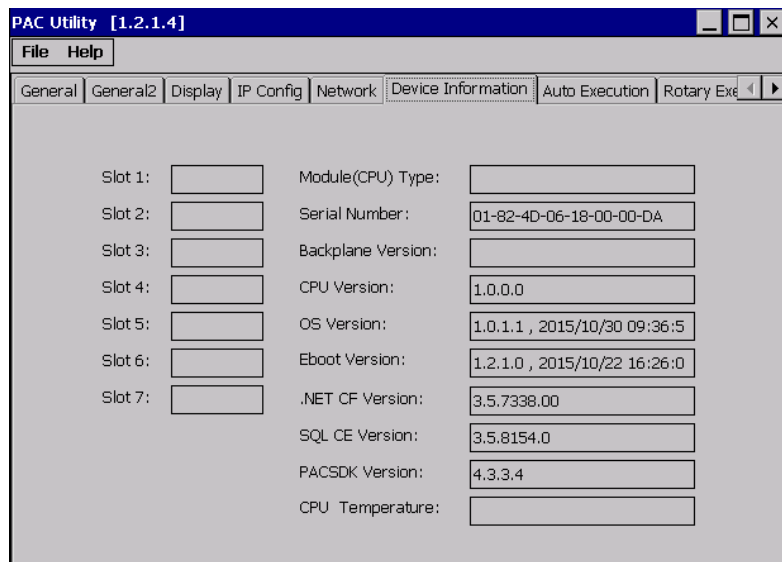

## 7.2. SDK Updates

SDK update is a part of the WP-9000-CE7 update services to provide additional and more efficient features and functionality for WP-9000-CE7 operating system.

The SDK update files can be found separately on the CD that was provided with the package or by downloading the latest version from ICP DAS web site.

CD:\wp-9000\SDK\  
[http://ftp.icpdas.com/pub/cd/winpac\\_am335x/wp-9000/sdk/](http://ftp.icpdas.com/pub/cd/winpac_am335x/wp-9000/sdk/)

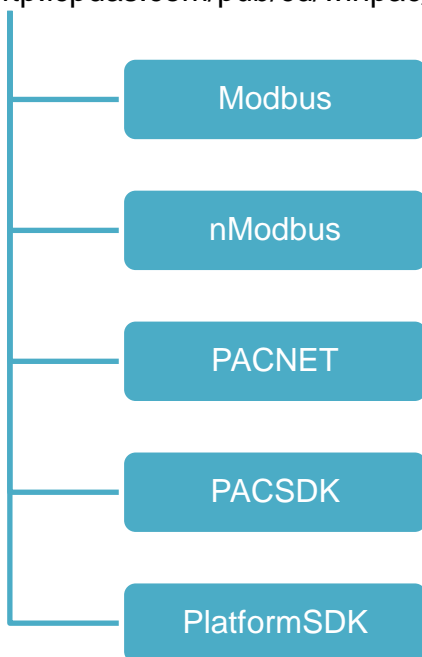

### 7.2.1. SDK Updates for VB.NET or C#

The SDK can be updated by changing the SDK file.

#### **Step 1: Get the latest version of the PACNET.dll file**

The latest version of the PACNET.dll file can be obtained from ICP DAS web site.

[http://ftp.icpdas.com/pub/cd/winpac\\_am335x/wp-9000/sdk/pacnet/](http://ftp.icpdas.com/pub/cd/winpac_am335x/wp-9000/sdk/pacnet/)

#### **Step 2: Copy the latest version of PACNet.dll file to PC and WP-9000-CE7**

The PACNET.dll file on PC can be placed anywhere only the solution can reference it.

The PACNET.dll file on WP-9000-CE7 is located at the same directory as the .exe file.



## 7.2.2. SDK Updates for VB.NET or Visual C++

The SDK can be updated by changing the SDK file.

### Step 1: Get the latest version of the VC++ components

The latest version of the VC++ components can be obtained from:

[http://ftp.icpdas.com/pub/cd/winpac\\_am335x/wp-9000/sdk/pacsdk/](http://ftp.icpdas.com/pub/cd/winpac_am335x/wp-9000/sdk/pacsdk/)

### Step 2: Copy the latest version of header files and libraries to PC

The header files are located at:

C:\Program Files\Windows CE Tools\SDKs\AM335x\_WINCE7\_SDK\Include\Armv4i

The libraries are located at:

C:\Program Files\Windows CE Tools\SDKs\AM335x\_WINCE7\_SDK\Lib\ARMv4I

### Step 3: Copy the latest version of DLL files to WinPAC

The DLL files are located at:

\System\_Disk\ICPDAS\System

# 8. WP-9000-CE7 Download Center

This chapter provides a brief introduction of the WP-9000-CE7 download center.

WP-9000-CE7 has a download center where you can access the latest version of the software, tools, demo programs, and related information.

The WP-9000-CE7 Download Center can be found at:

[http://www.icpdas.com/root/support/download/pac/wp-9000-ce7/wp-9000-ce7\\_download\\_os\\_images.html](http://www.icpdas.com/root/support/download/pac/wp-9000-ce7/wp-9000-ce7_download_os_images.html)

## WP-9000-CE7 Download Center

**Note:**

When you download the software programs, you should notice if the programs conform to your machine. Before you download any program, please read the notes of each online program first to avoid the confused situation.

OS imagesSDKUtility & ToolsDemoDocumentsSystem DiskFAQ

### OS images download

**Note:**  
Before you download the software programs, you should notice if the programs are compatible to your machine. *Please read the notes first in each chapter you want before download programs.*

**Touch Panel driver**  
WP-9000-CE7 provide drivers of PenMount, and ELO touch panels (USB/RS-232). Please download the driver(s) to your WinPAC and double-click it to install the driver.

**Touch Panel driver download**

Support type	Model
PenMount USB TOUCH	<a href="#">ADP-1080T-U</a>
PenMount Serial TOUCH	<a href="#">ADP-1080T-R</a>
ELO USB TOUCH	ELO USB touch panel
ELO Serial TOUCH	ELO RS-232 touch panel



**How to upgrade OS image of WP-9000-CE7**  
There are two methods to upgrade OS image of WP-9000-CE7. The first one is to run installation package file on WinPAC and the second is to use Eshell.exe to upgrade OS image through Ethernet.

## Tips – How to

This chapter provides tips and a guided tour on using and maintaining the WP-9000-CE7.

## A. How to Use the Printer

WP-9000-CE7 have ability to access the printer, the printer can be connected via an Ethernet or a USB.

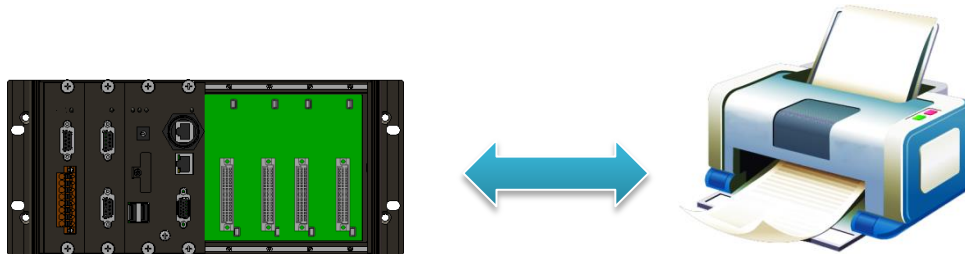

---

### Tips & Warnings



WP-9000-CE7 only supports HP Laser Jet Printers with PCL6 driver. The following printer support is released by HP:

- HP LaserJet 4000 series/HP LaserJet 4100 series
- HP LaserJet 2100 series/HP LaserJet 2200 series
- HP LaserJet 1200
- HP LaserJet 3200/HP LaserJet 3300
- HP LaserJet 4200 series/HP LaserJet 4300 series
- HP LaserJet 5000 series/HP LaserJet 5100 series
- HP LaserJet 8000 series
- HP LaserJet 9000 series printers

If you need the latest support of HP PCL6 printer, you can refer to following link

<http://h20000.www2.hp.com/bizsupport/TechSupport/Document.jsp?objectID=bpl04568>

## A.1. How to Use a Network Printer

Here are step by step instructions on how to use a shared printer.

### Step 1: On PC side, check the name of the PC and the shared printer

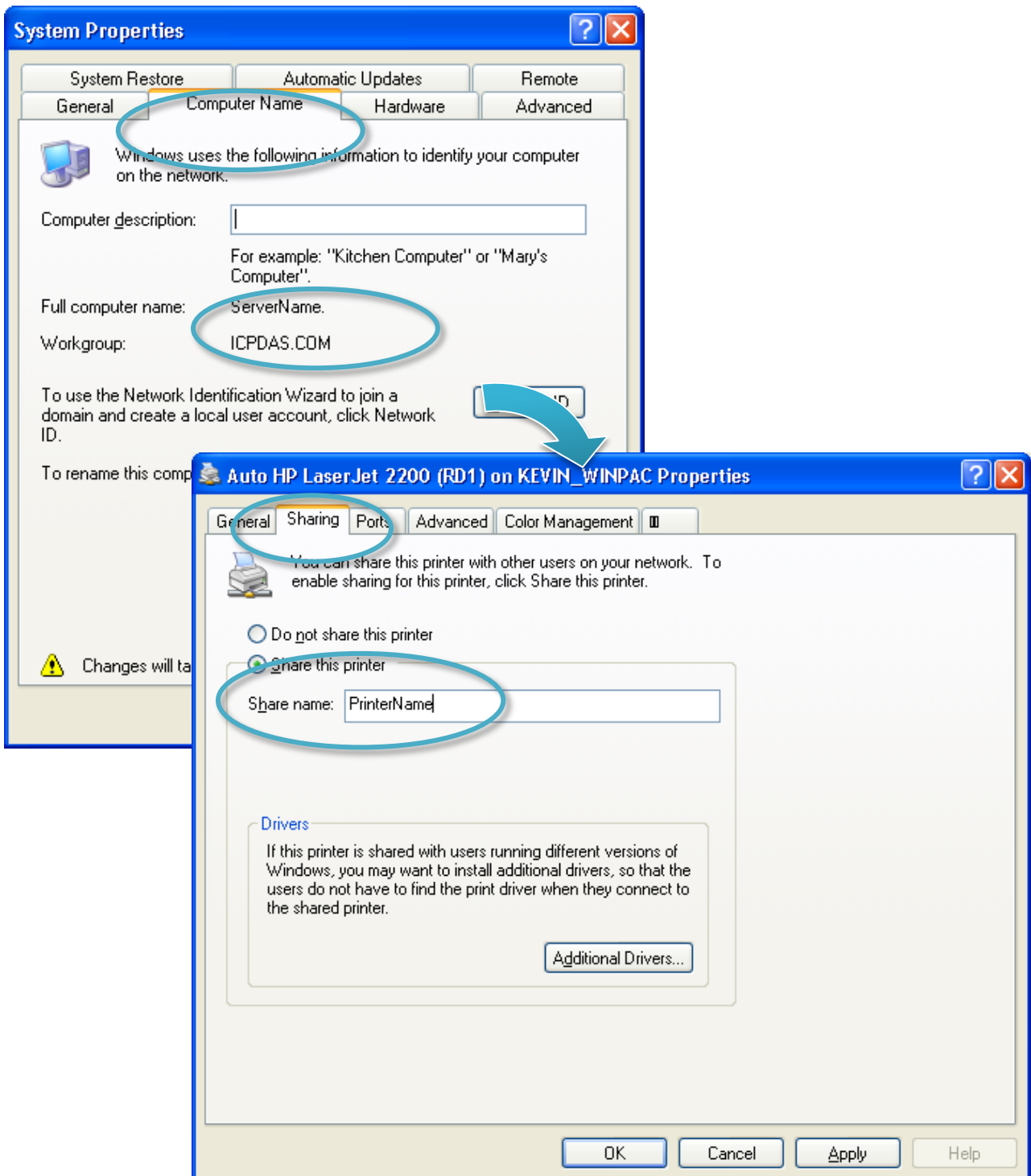

**Step 2: On WP-9000-CE7 – Run the Notepad, and then open a WordPad format file**

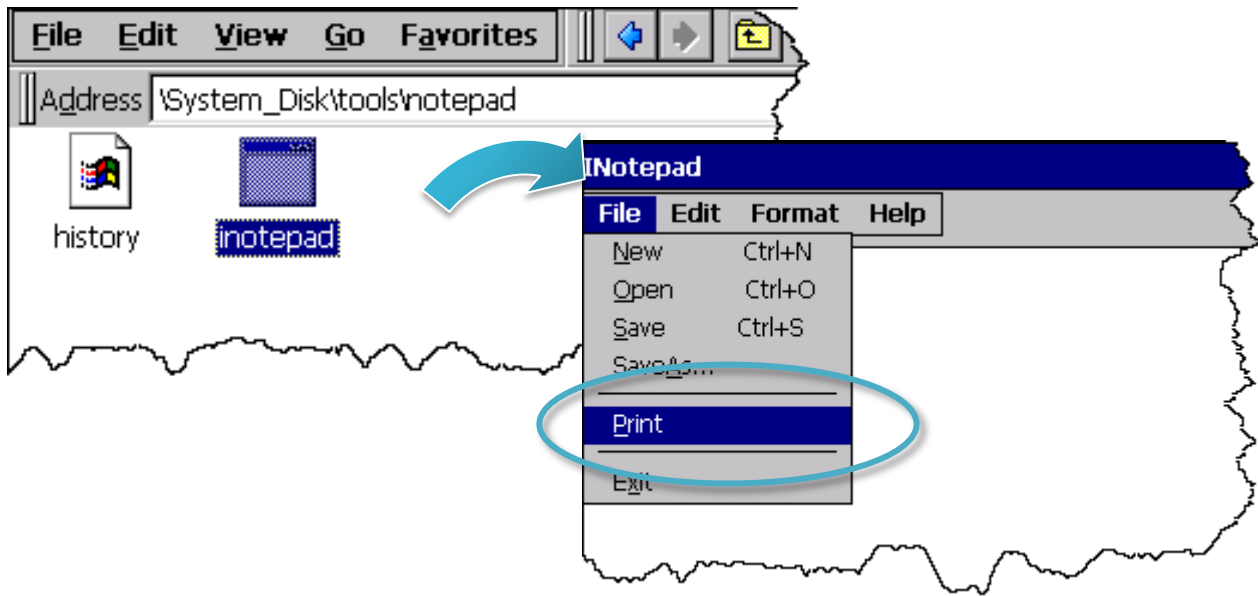

**Step 3: Set up the printer**

1. Printer: PCL Laser
2. Port: Network
3. Net Path: \\ServerName\PrinterName

The "ServerName" is the name or IP of the PC.

The "PrinterName" is the name of share printer of the PC.

4. Paper Size: Select the paper size



**Test !!!**

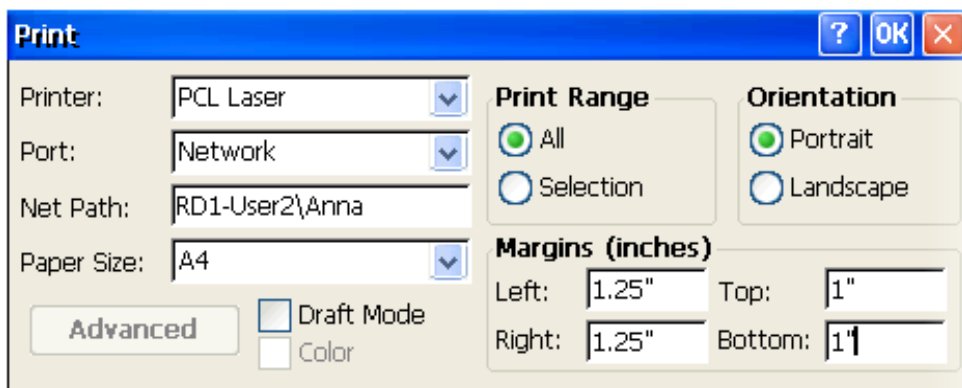

## A.2. How to Use a USB printer

Here are step by step instructions on how to use a USB printer via a USB port.

### Step 1: Run the Notepad, and then open a WordPad format file

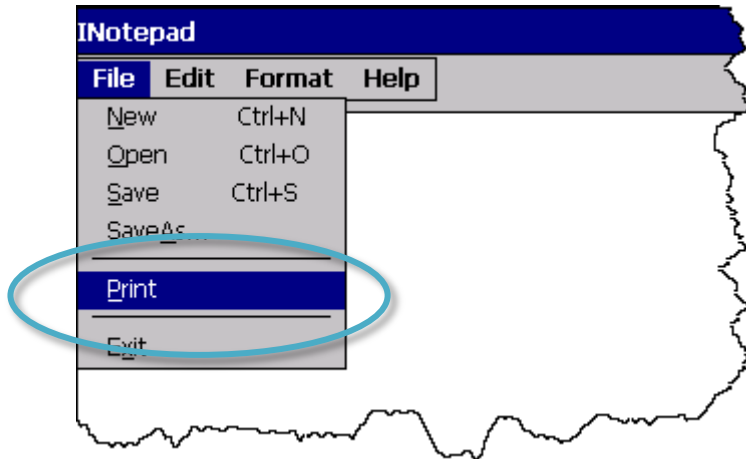

### Step 2: Set up the printer

1. Printer: Hewlett-Packard LaserJet
2. Port: LPT1
3. Paper Size: Select the paper size



**Test !!!**

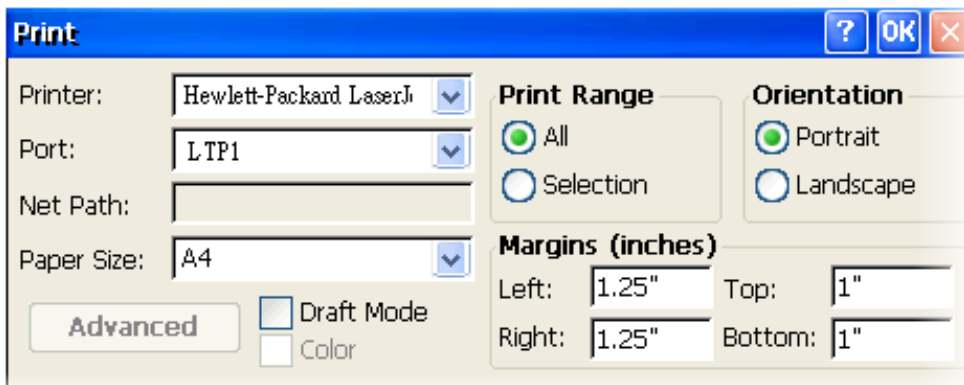

## B. How to Online Debug the WP-9000-CE7 Program

Here are step by step instructions on how to online debug the WP-9000-CE7 program.

### Tips & Warnings



Before starting online debug the WP-9000-CE7 program, make sure that the WP-9000-CE7 SDK has been installed correctly.

For more information on how to install the WP-9000-CE7 SDK, please refer to 4.1.2. Installing the WP-9000-CE7 SDK.

### Step 1: Copy the following files to the \System\_Disk\icpdas\system on the WP-9000-CE7

By default, these files are located on the development computer at C:\Program Files\Common Files\Microsoft Shared\CoreCon\1.0\Target\wce400\<CPU>.

- clientshutdown.exe
- CMAccept.exe
- ConmanClient2.exe
- eDbgTL.dll
- TcpConnectionA.dll

### Step 2: Run the ConmanClient2.exe and then CMAccept.exe on the WP-9000-CE7

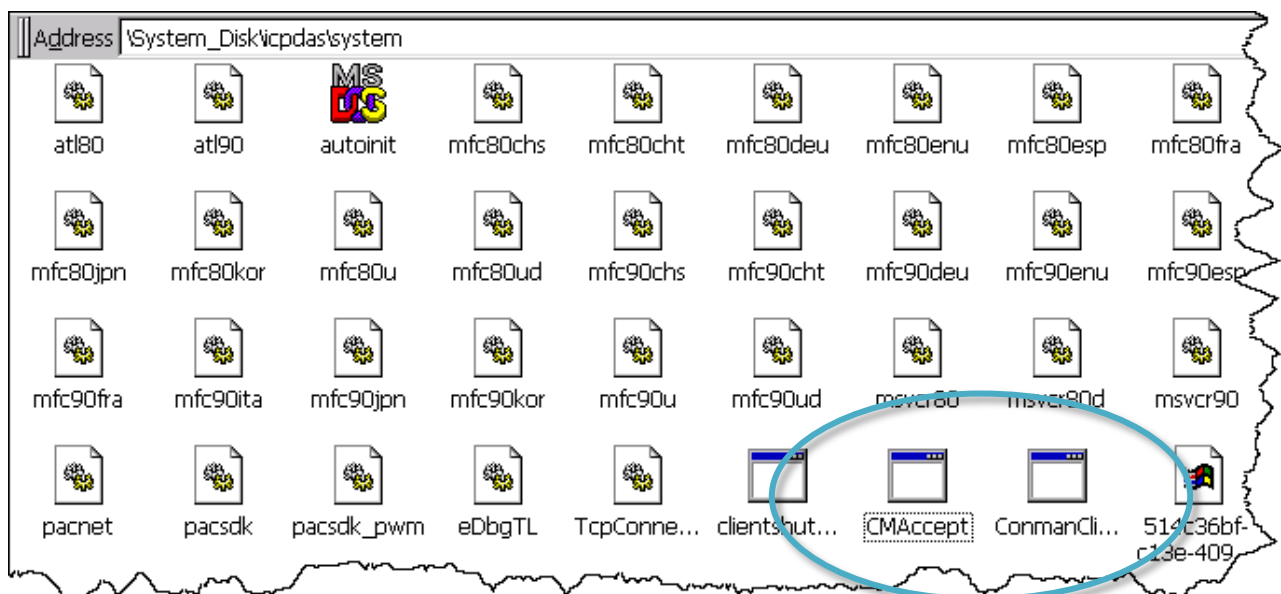



**Step 3: On the Tools menu, click the Options**

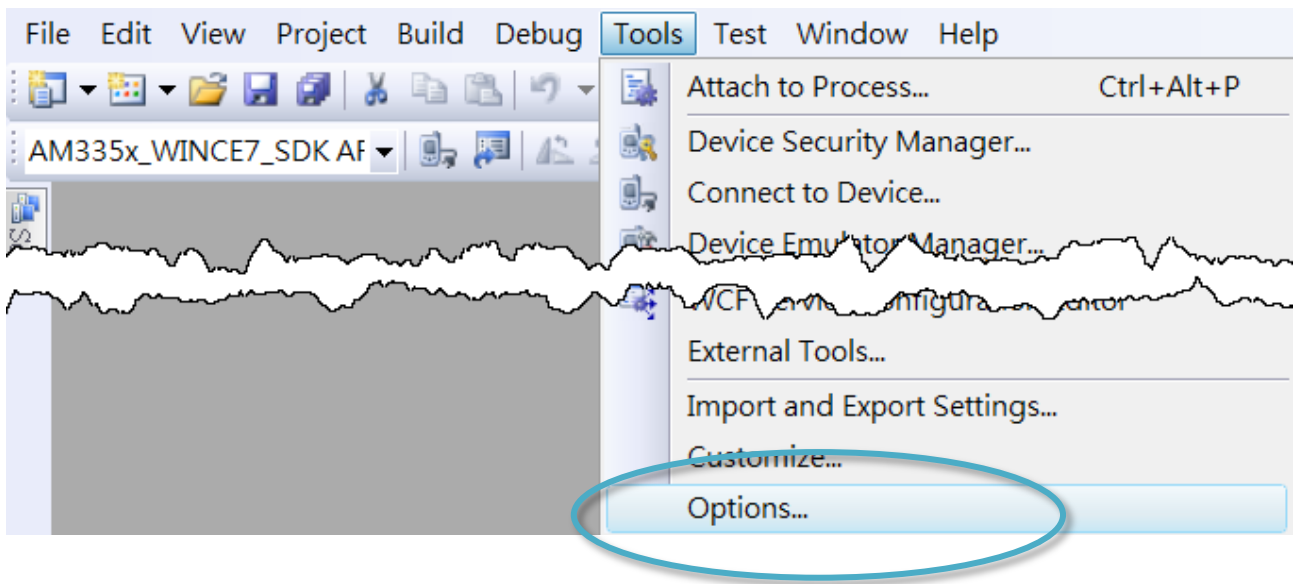

**Step 4: In the left pane, expand Device Tools node and select Devices**

**Step 5: In the Show devices for platform:, select AM335x\_WINCE7\_SDK and then click Properties**

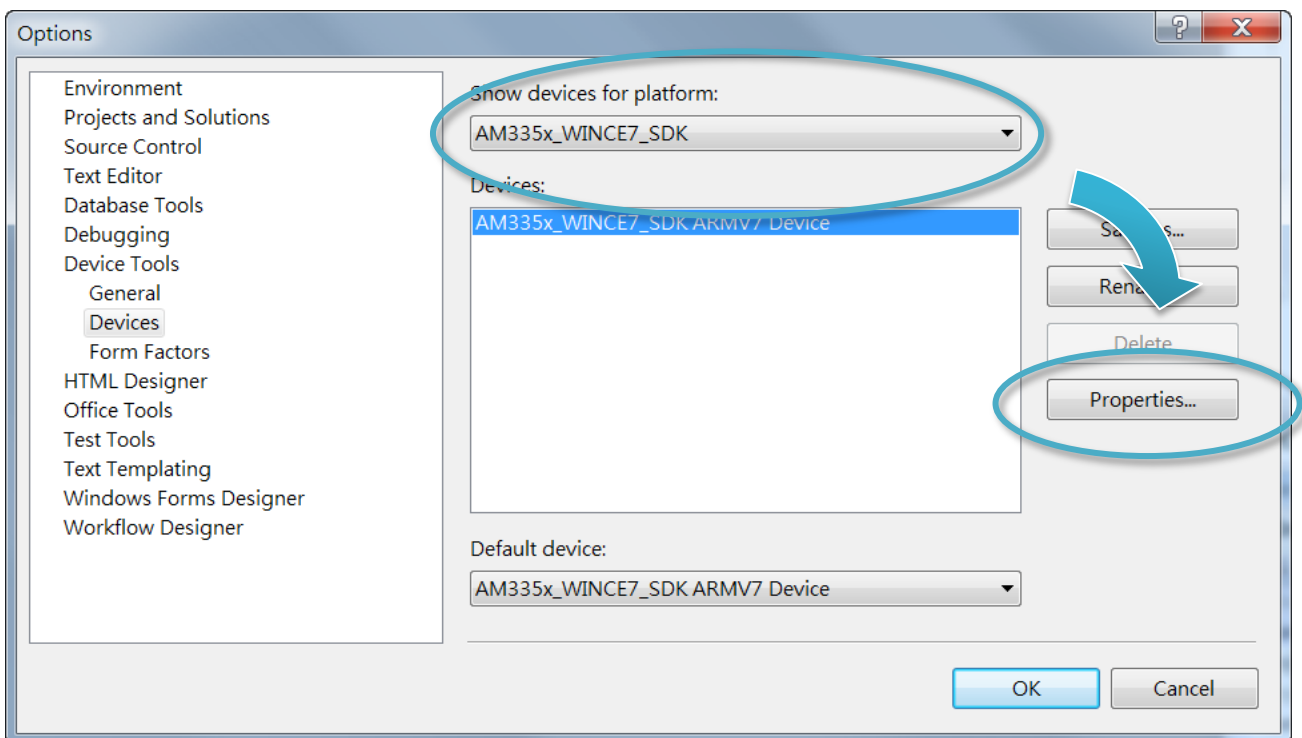

**Step 6: Click the Configure...**

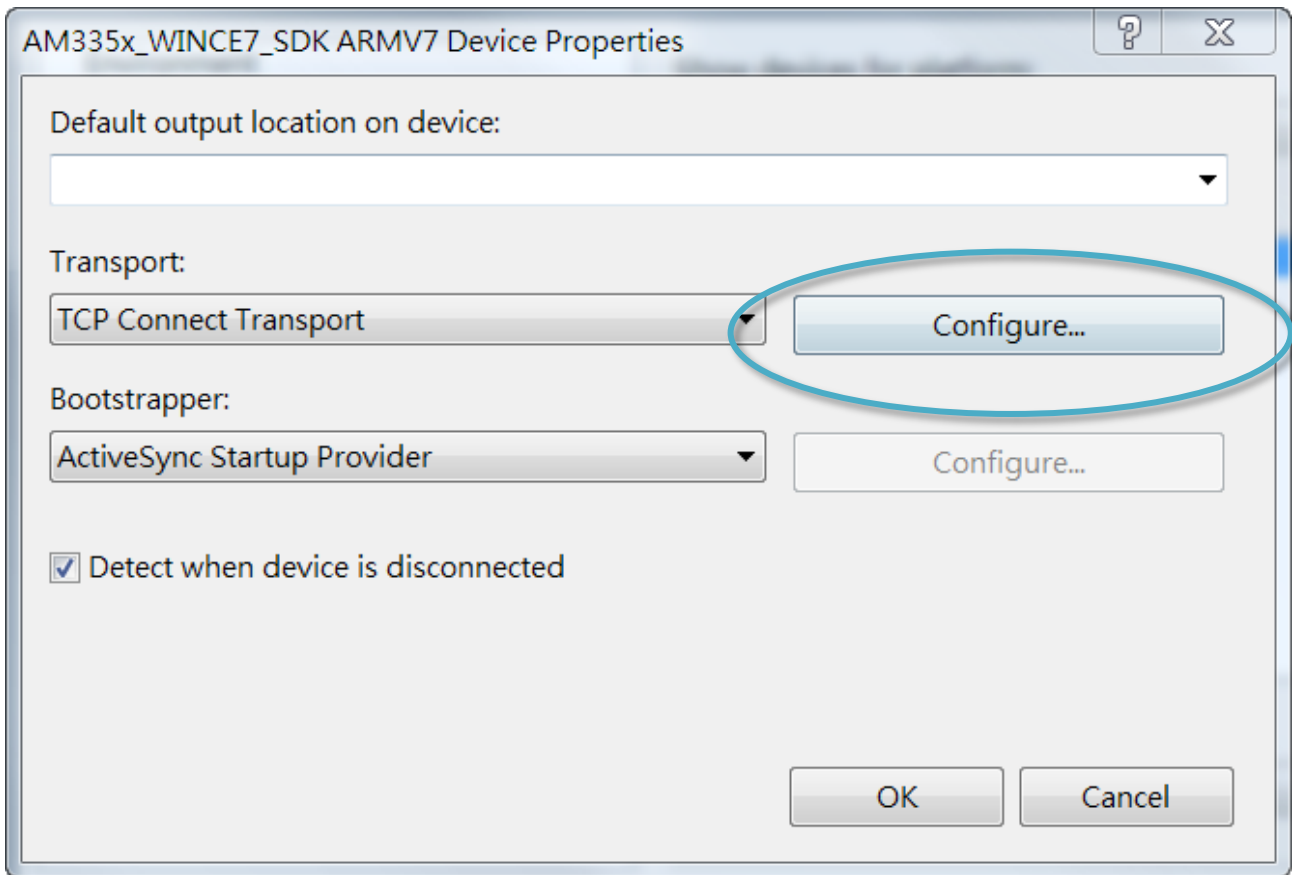

**Step 7: Select the Use specific IP address:, and then type the IP address of WP-9000-CE7**

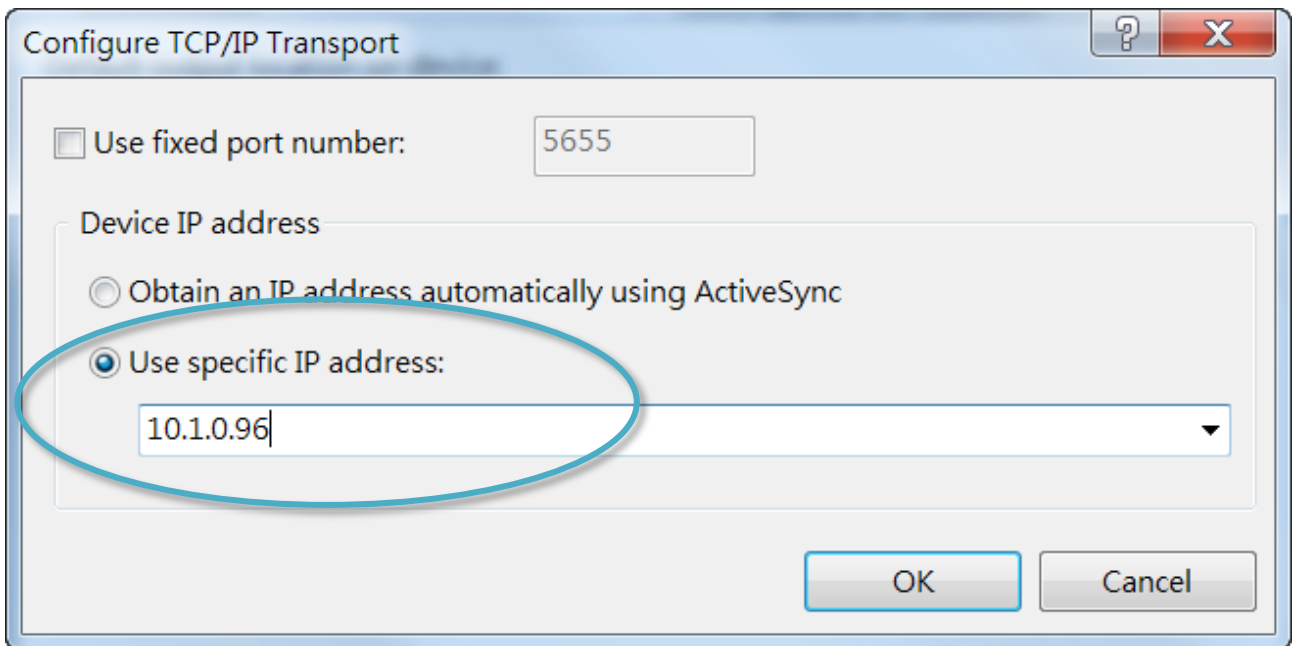

**Step 8: Click the OK, and then click OK to end the dialog**

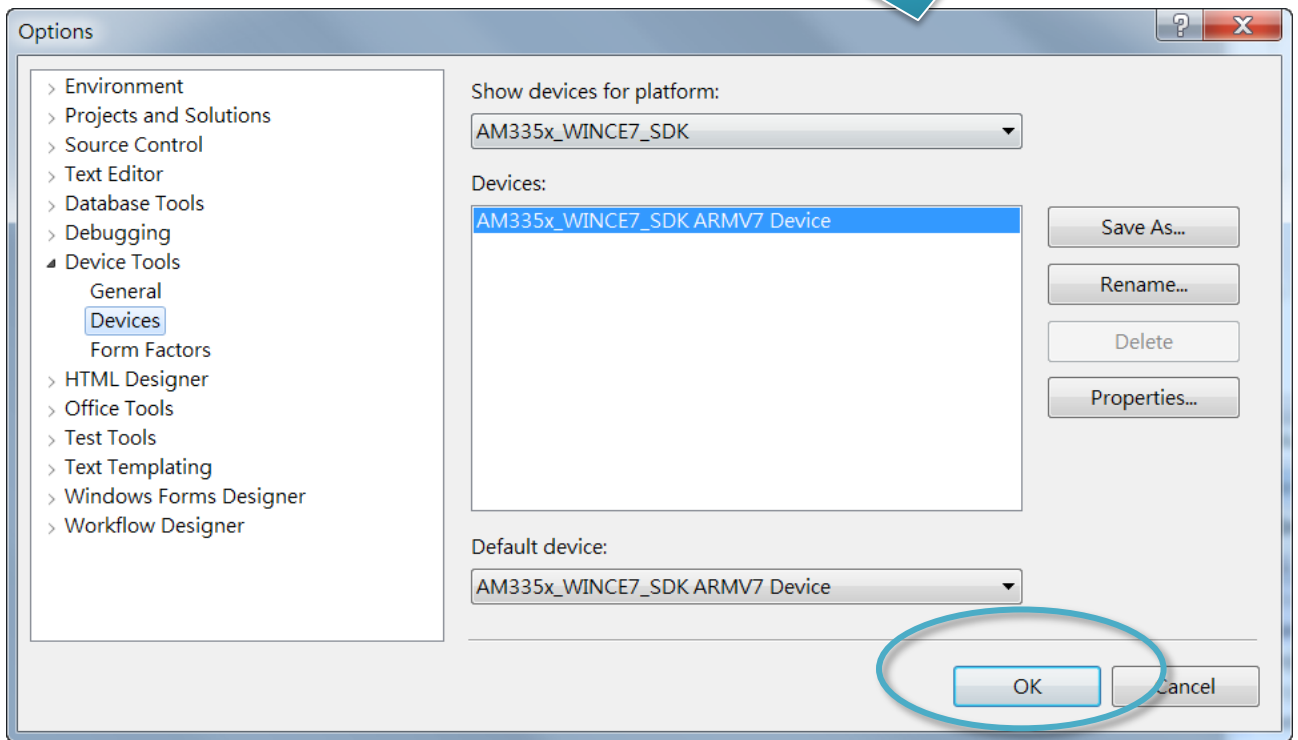
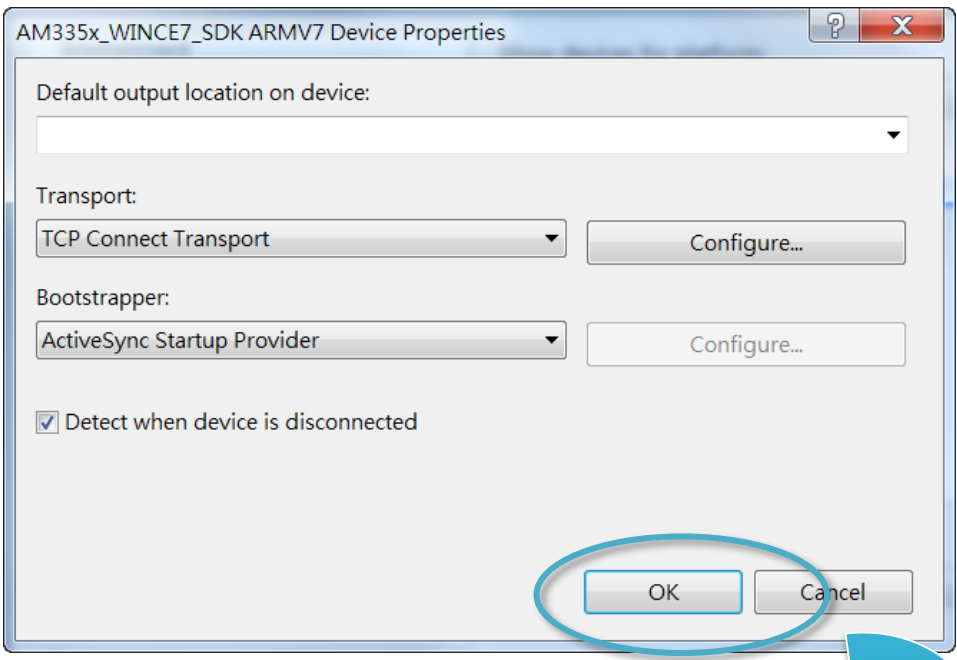

**Step 9: On the Tools menu, click the Connect to Device...**

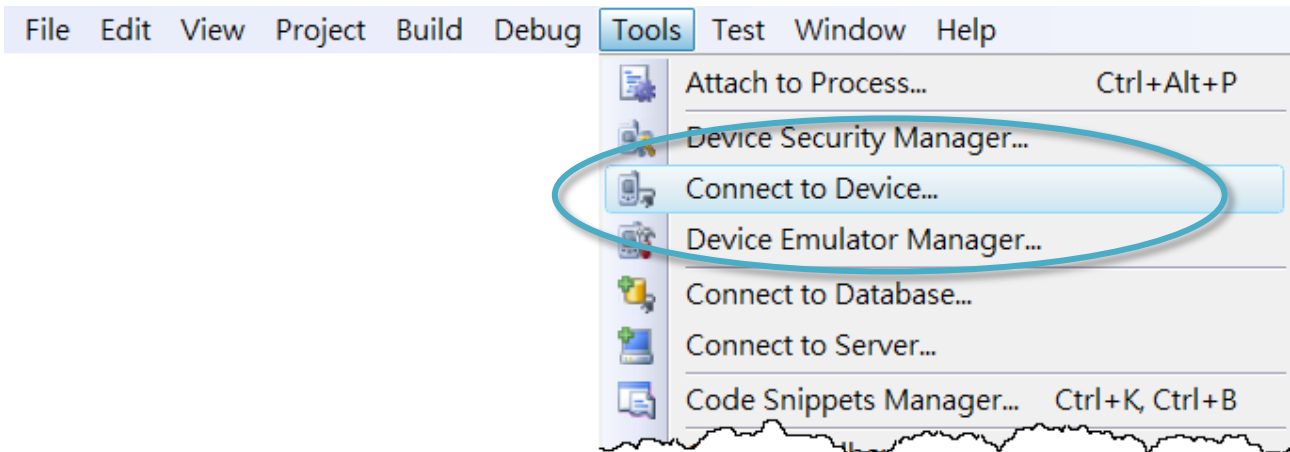

**Step 10: Wait for the connection to be established**

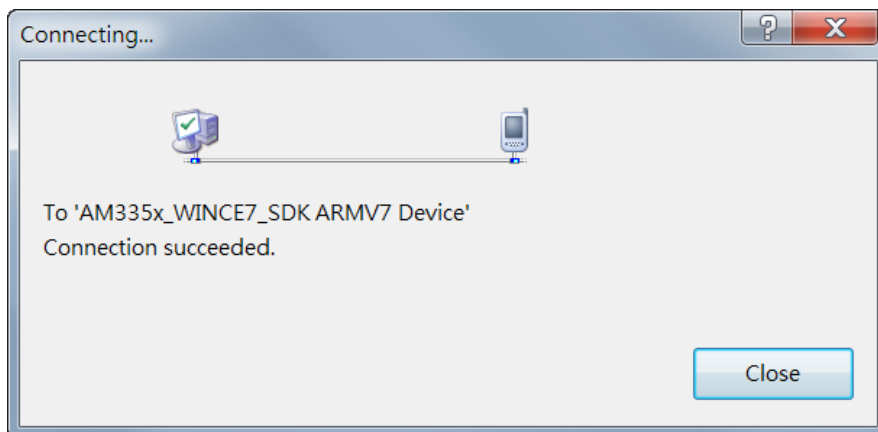

**Tips & Warnings**



If the connection fails, as shown below, please repeat the step 2 to step 9 to try it again.

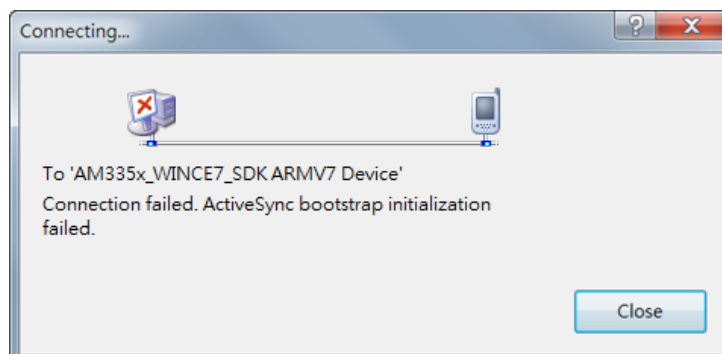

## C. How to Automatically Synchronize WP-9000-CE7 Clock with an Internet Time Server

The clock on the WP-9000-CE7 can be synchronized with an internet time server. This means that the clock is updated to match the clock on the time server, which can help ensure that the time on the WP-9000-CE7 is accurate. Here are step by step instructions on how to synchronize the clock on the WP-9000-CE7 with an Internet time server.

### Step 1: Run the PAC Utility



### Step 2: On the General tab, press Configure button

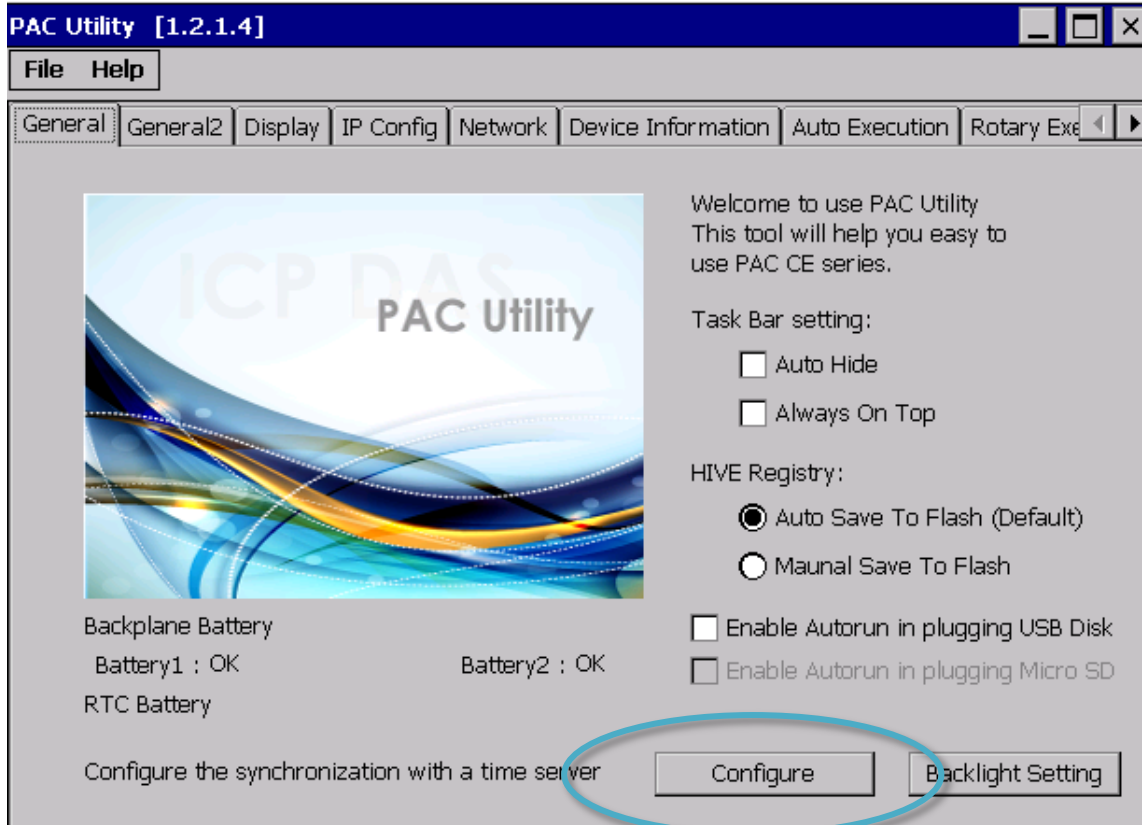

**Step 3: Select the domain name from the Server drop-down list, and then enter a value in the Autoupdate Frequency field**

**Step 4: Check the Automatically synchronize with an internet time server check box**

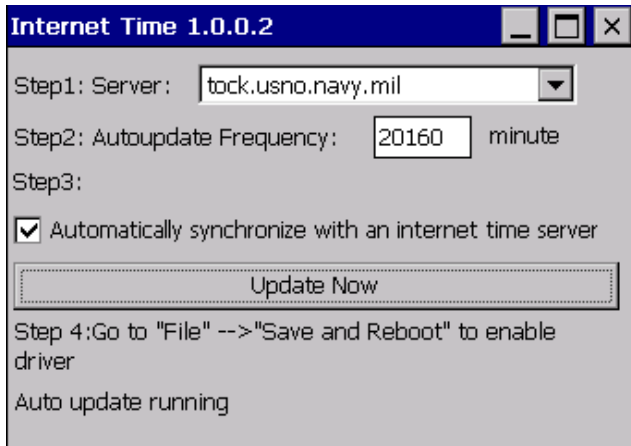

**Step 5: On the File menu, click Save and Reboot**

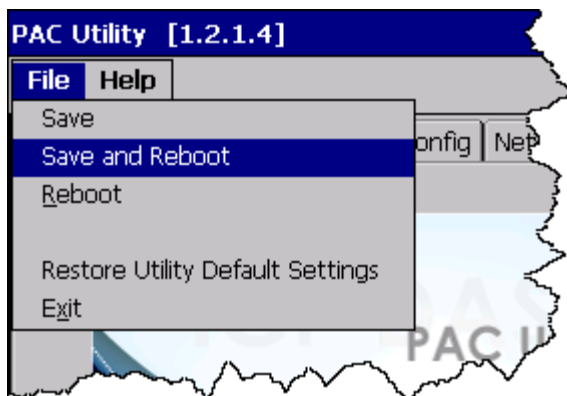

**Step 6: The WP-9000-CE7 will automatically synchronize with an internet time server regularly**

**Step 7: Click the Update Now button to synchronize WP-9000-CE7 clock immediately**

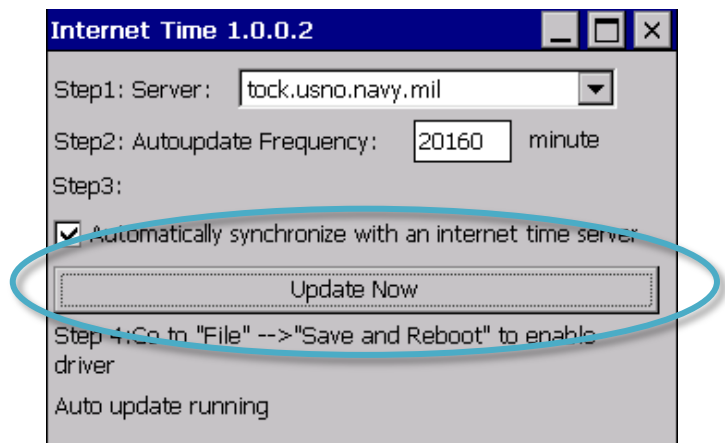

## **D. How to Control the User Account Control in WP-9000-CE7**

User Account Control is a security feature that helps prevent unauthorized system changes to the WP-9000-CE7.

## D.1. How to Create a User Account

Here are step by step instructions on how to add a user account.

### Step 1: Run the PAC Utility



### Step 2: On the Login tab of the Network tab, click Login tab, type the User Name and Password, and then click Add button

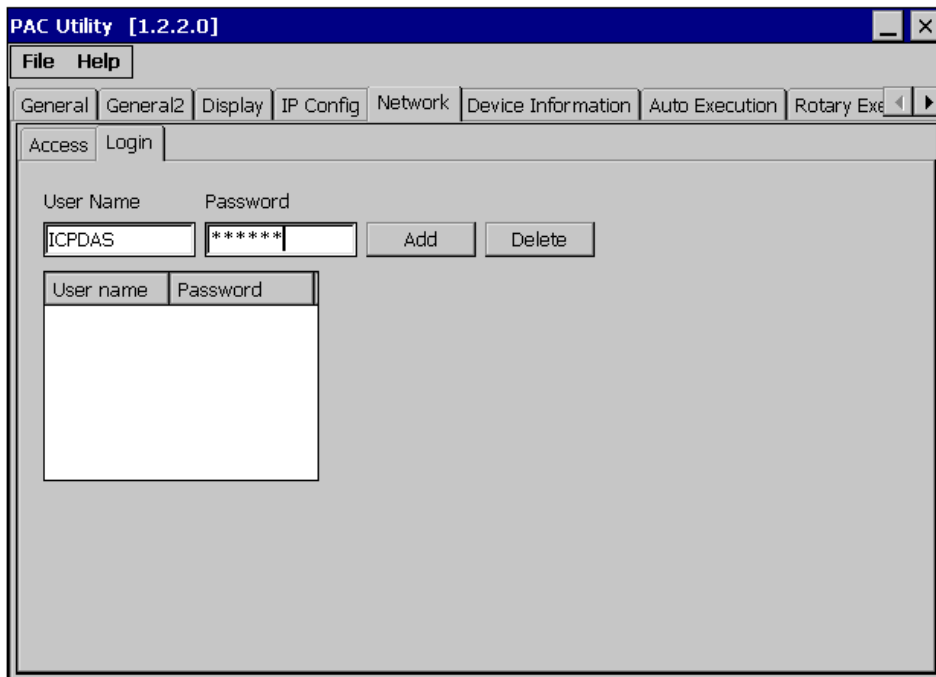



**Step 3: The user has been added to the allowed under the remote login and included in the following list**

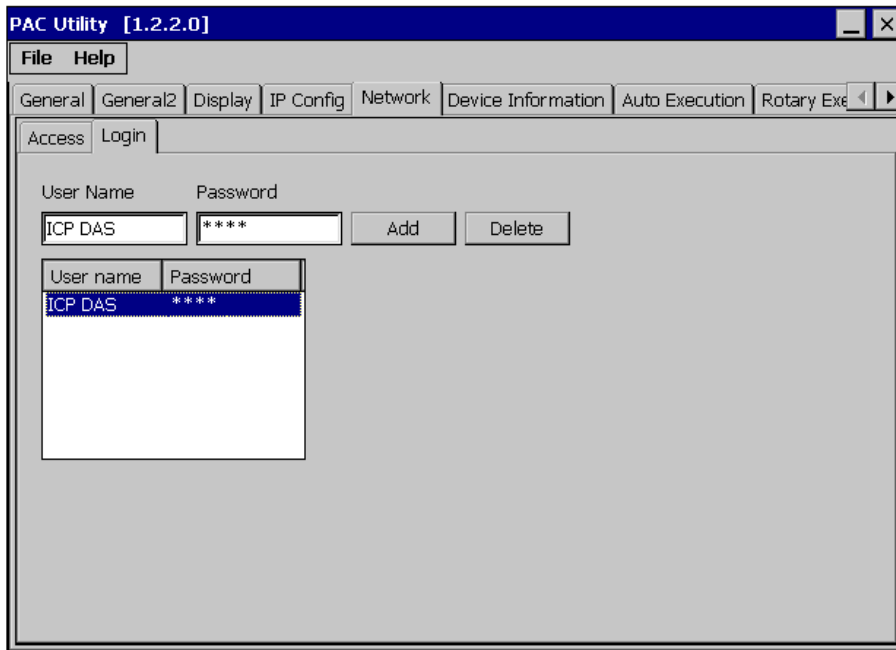

**Step 4: On the File menu, click Save and Reboot for changes to take effect**

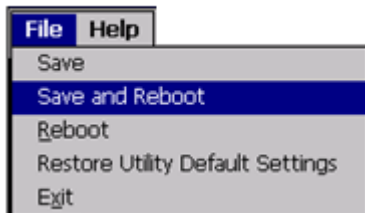

## D.2. How to Telnet to Remote Login the WinPAC from PC

Here are step by step instructions on how to use telnet to remote login the WinPAC from PC.

### Step 1: On the PC, open a MS-DOS command prompt

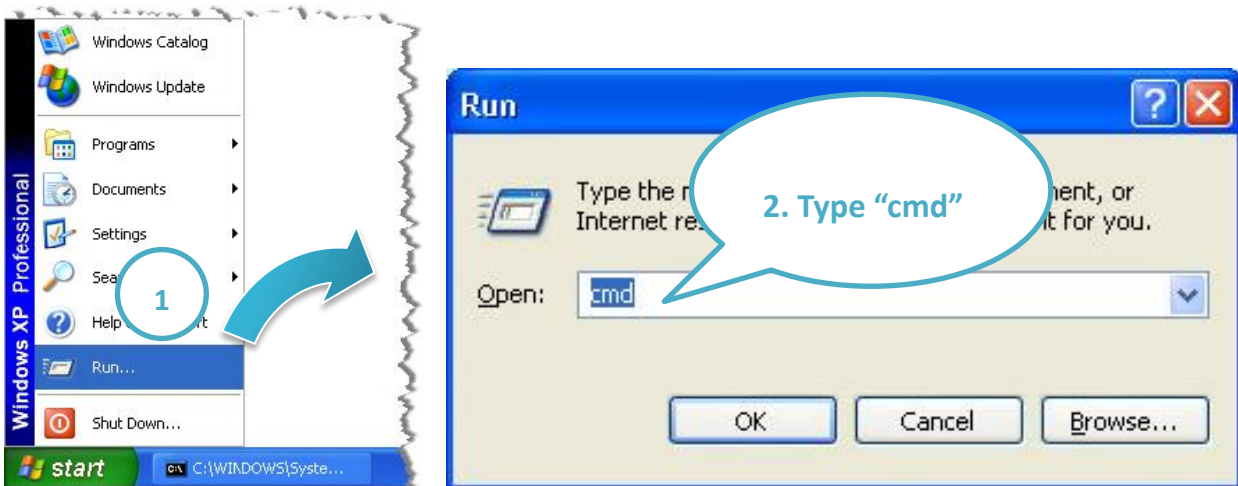

### Step 2: At the command prompt, type "telnet (IP address)"

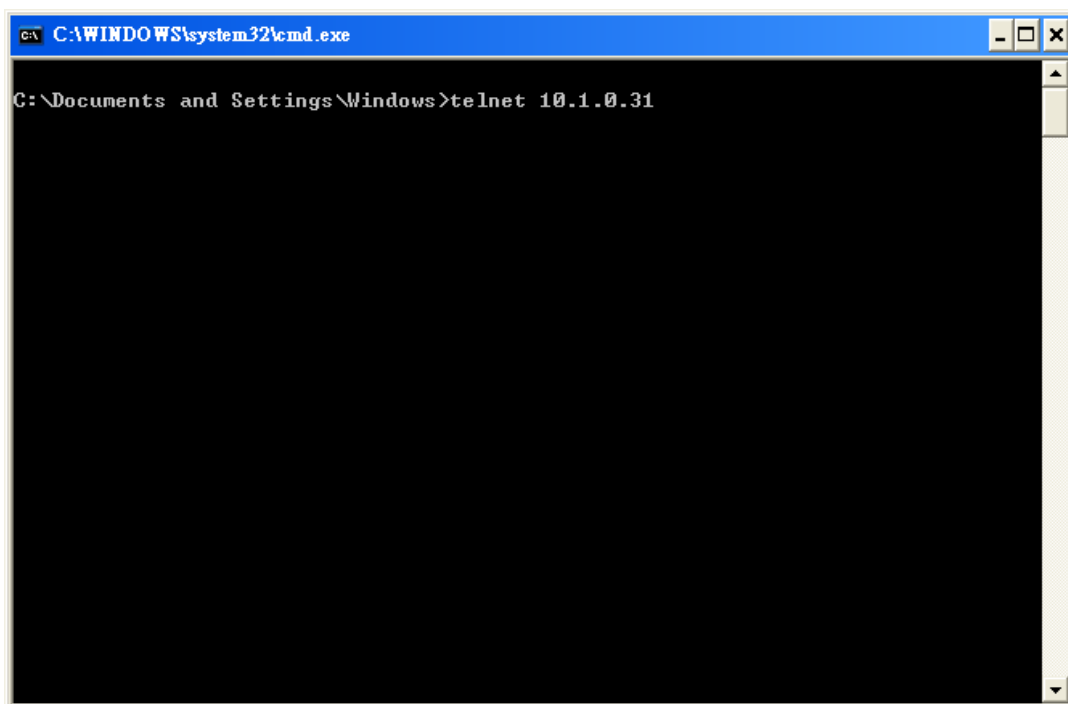

**Step 3: The connection has been set up, and then type the name and password**

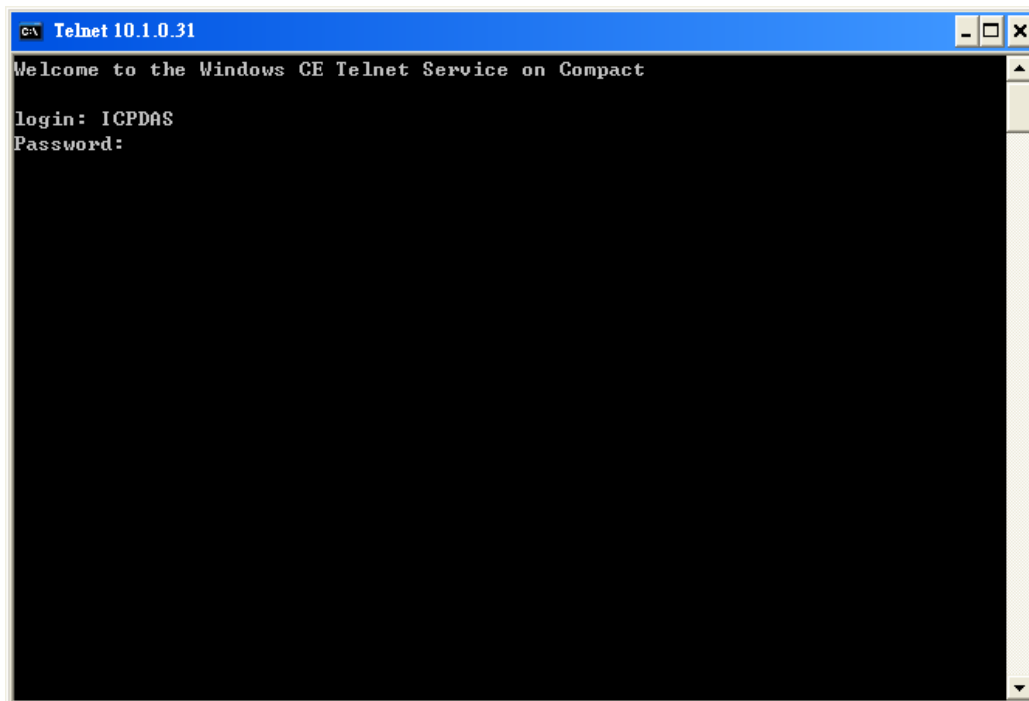

**Step 4: The remote login has been completed**

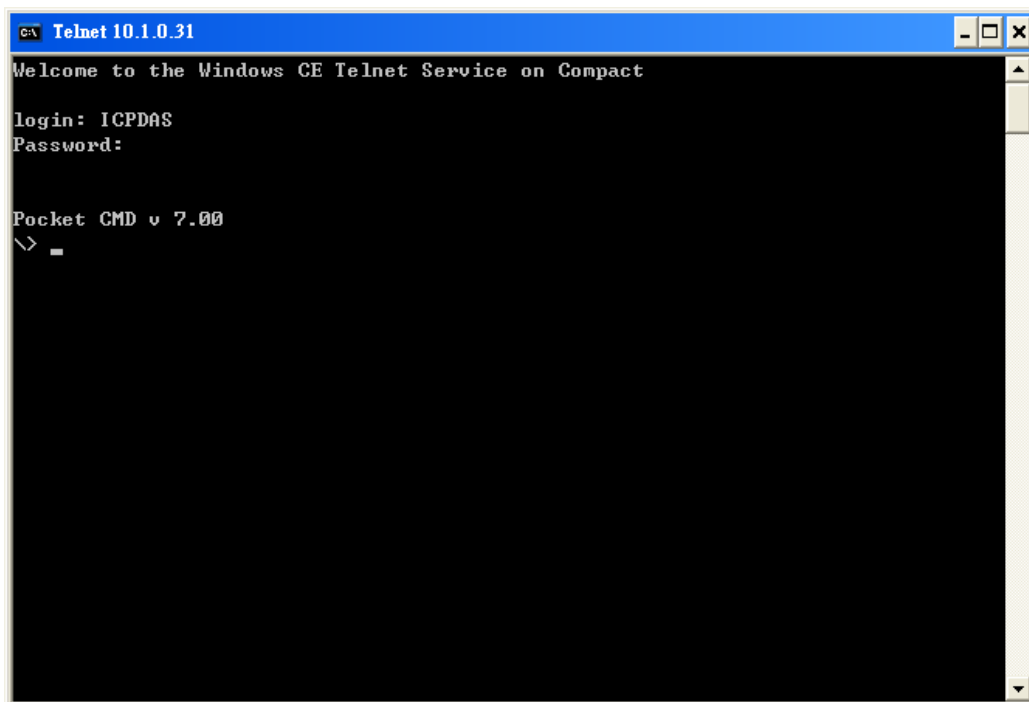

### D.3. How to Remove a User Account from the Login List

Here are step by step instructions on how to remote the user from the login list.

**Step 1: Click a user from the list which you want to remove, and the user will display in the field, and then press Delete to delete the user from the login list**

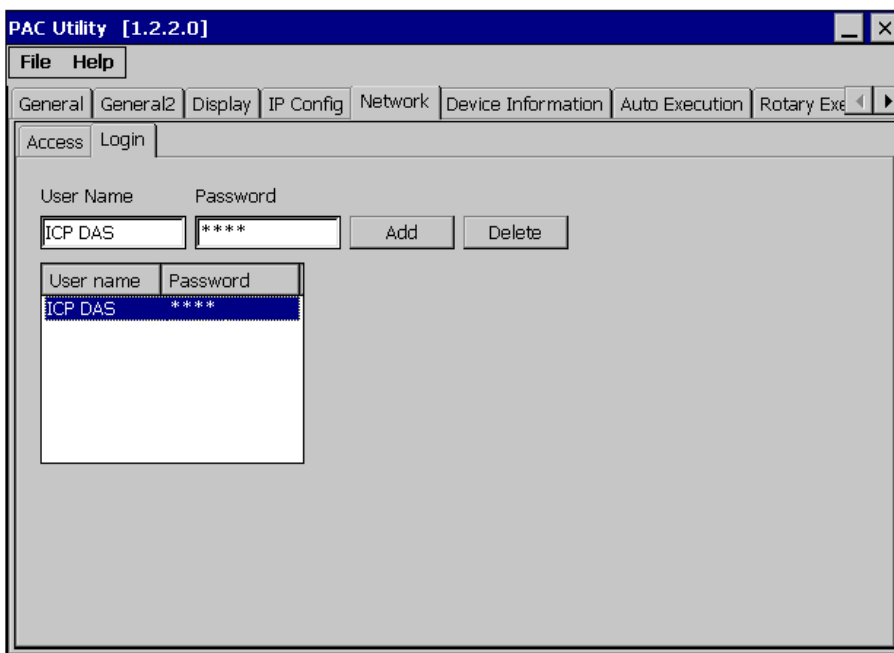

**Step 2: On the File menu, click Save and Reboot for changes to take effect**

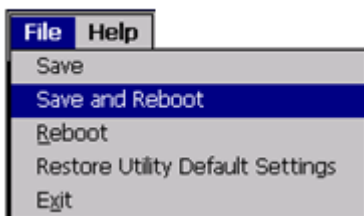

## E. Revision History

This chapter provides revision history information to this document.

The table below shows the revision history.

Revision	Date	Description
1.0.0	January 2016	Initial issue