

PETL/tET/tPET DIO Series User Manual

Ethernet I/O Modules

Ver.2.2.1, Mar. 2018



WARRANTY

All products manufactured by ICP DAS are warranted against defective materials for a period of one year from the date of delivery to the original purchaser.

WARNING

ICP DAS assumes no liability for damages consequent to the use of this product. ICP DAS reserves the right to change this manual at any time without notice. The information furnished by ICP DAS is believed to be accurate and reliable. However, no responsibility is assumed by ICP DAS for its use, nor for any infringements of patents or other rights of third parties resulting from its use.

COPYRIGHT

Copyright © 2017 by ICP DAS. All rights are reserved.

TRADEMARK

Names are used for identification only and may be registered trademarks of their respective companies.

CONTACT US

If you have any questions, please feel free to contact us via email at:

service@icpdas.com, service.icpdas@gmail.com

SUPPORT

This manual relates to the following modules:

PETL-7060

tET-P6, tPET-P6

tET-PD6, tPET-PD6

tET-C4, tPET-C4

tET-A4, tPET-A4

tET-P2C2, tPET-P2C2

tET-P2A2, tPET-P2A2

tET-P2POR2, tPET-P2POR2,

tET-PD2POR2, tPET-PD2POR2

tET-P2R2, tPET-P2R2

tET-PD2R1, tPET-PD2R1

TABLE OF CONTENTS

PACKING LIST	4
MORE INFORMATION	4
1. INTRODUCTION	5
1.1 PRODUCT INFORMATION.....	6
1.1.1 Ethernet IO Module Series.....	6
1.1.2 Selection Guide	8
1.1.3 Comparison of PETL/tET/tPET Module.....	9
1.2 FEATURES.....	11
2. HARDWARE INFORMATION	14
2.1 FRONT AND BACK PANEL.....	14
Ethernet Port	15
J1 Connector.....	15
Operating Mode Switch.....	17
System LED Indicator	18
J2 Connector.....	18
2.2 SPECIFICATIONS.....	19
2.2.1 System Specifications.....	19
2.2.2 I/O Specifications.....	20
2.3 PIN ASSIGNMENTS	25
tET-P6/tPET-P6/tET-PD6/tPET-PD6.....	25
tET-C4/tPET-C4/tET-A4/tPET-A4.....	26
tET-P2POR2/tPET-P2POR2/tET-P2R2/tPET-P2R2	27
tET-PD2POR2/tPET-PD2POR2	28
tET-PD2R1/tPET-PD2R1.....	29
tET-P2C2/tPET-P2C2/tET-P2A2/tPET-P2A2.....	30
PETL-7060	31
2.4 WIRING CONNECTIONS	32
2.4.1 Input Wiring	32
2.4.2 Output Wiring	33
2.5 DIMENSIONS.....	35
3. GETTING STARTED	37
3.1 MOUNTING THE MODULE.....	37
3.2 CONFIGURING THE BOOT MODE.....	39
3.3 CONNECTING TO A NETWORK, A PC AND A POWER SUPPLY	40
3.4 USING THE eSEARCH UTILITY TO ASSIGN A NEW IP	41
4. WEB CONFIGURATION	44
4.1 LOGGING IN TO THE WEB SERVER	44
4.2 HOME.....	46
4.3 NETWORK SETTINGS	48
IP Address Configuration.....	48
General Settings.....	51
Restore Factory Defaults	52
Firmware Update	54

- 4.4 I/O SETTINGS 55
 - DO Control* 55
 - DI/DO Configuration* 56
- 4.5 SYNC..... 59
 - DIO Synchronization* 59
- 4.6 PWM 61
 - PWM Configuration*..... 61
- 4.7 PAIR 63
 - Pair-Connection Settings*..... 63
- 4.8 FILTER 66
 - Filter Settings* 66
- 4.9 MONITOR 68
- 4.10 CHANGE PASSWORD 68
- 4.11 LOGOUT 69
- 5. I/O PAIR CONNECTION APPLICATIONS70**
 - 5.1 ONE MODULE POLLING THE REMOTE DI/DO (1-TO-1, POLLING MODE) 70
 - Polling Mode* 72
 - Push Mode*..... 73
 - 5.2 TWO MODULES PUSHING THE LOCAL DI TO EACH OTHER (1-TO-1, PUSH MODE) 74
 - 5.3 SEVERAL MODULES POLLING THE REMOTE DI (M-TO-1) (POLLING MODE)..... 77
 - 5.4 SEVERAL MODULES PUSHING THE LOCAL DI (M-TO-1) (PUSH MODE) 80
- 6. MODBUS INFORMATION83**
 - 6.1 WHAT IS MODBUS TCP/IP? 84
 - 6.2 MODBUS MESSAGE STRUCTURE 84
 - 01(0x01) Read the Status of the Coils (Readback DOs)*..... 88
 - 02(0x02) Read the Status of the Input (Read DIs)* 90
 - 03(0x03) Read the Holding Registers (Readback AOs)* 92
 - 04(0x04) Read the Input Registers (Read AIs)* 94
 - 05(0x05) Force a Single Coil (Write DO)* 96
 - 06(0x06) Preset a Single Register (Write AO)* 98
 - 15(0x0F) Force Multiple Coils (Write DOs)*..... 100
 - 16(0x10) Preset Multiple Registers (Write AOs)* 102
 - 6.3 MODBUS REGISTER TABLE 104
 - 6.3.1 *Common Functions*..... 104
 - 6.3.2 *Specific Functions*..... 106
- 7. RELATED TOOLS111**
 - 7.1 LABVIEW 111
 - 7.2 OPC SERVER 111
 - 7.3 SCADA..... 112
- APPENDIX: TROUBLESHOOTING114**
 - HOW DO I RESTORE THE WEB PASSWORD FOR THE MODULE TO THE FACTORY DEFAULT PASSWORD? 114
- APPENDIX B: REVISION HISTORY116**

Packing List

The shipping package includes the following items:

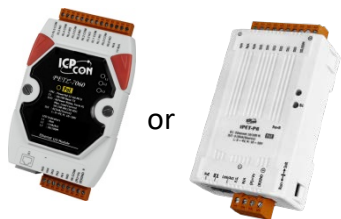

or



tET/tPET Series x 1

Quick Start x 1

Note

If any of these items are missing or damaged, please contact the local distributor for more information. Save the shipping materials and cartons in case you need to ship the module in the future.

More Information

➤ **Documentation**

CD:\NAPDOS\tpet\Document

<http://ftp.icpdas.com/pub/cd/tinymodules/napdos/tpet/document/>

➤ **Firmware**

CD:\NAPDOS\tpet\Firmware

<http://ftp.icpdas.com/pub/cd/tinymodules/napdos/tpet/firmware/>

➤ **Software**

CD:\NAPDOS\Software

<http://ftp.icpdas.com/pub/cd/tinymodules/napdos/software/>

1. Introduction

The tET/tPET and PETL-7060 series of devices are IP-based Ethernet I/O monitoring and control modules that provide networking ability and a variety of digital I/O functions. The modules can be remotely controlled through a 10/100 M Ethernet network using the Modbus TCP/UDP protocol. Modbus has become a de facto standard communications, and is now the most commonly available means of connecting industrial electronic devices. This makes the tET/tPET and PETL-7060series perfect for integration with HMI, SCADA, PLC and other software systems.

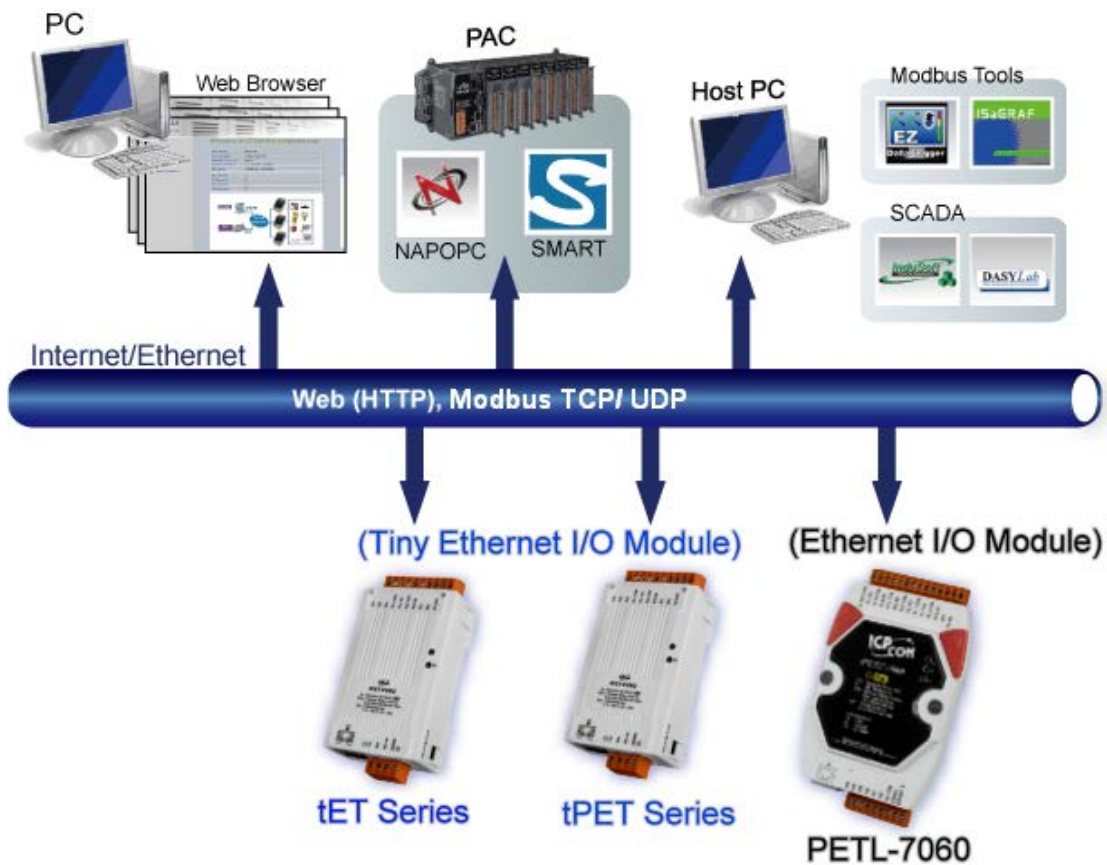

1.1 Product Information

1.1.1 Ethernet IO Module Series

The tET/tPET and PETL-7060 series of Ethernet I/O modules support a range of I/O formats, such as photo-isolated digital input, relay contact, PhotoMOS relay, and open-collector output, etc.

The table below provides a description of each model.

DC Digital Input	
tET-P6	Tiny Ethernet module with 6-channel digital input (Wet Contact)
tET-PD6	Tiny Ethernet module with 6-channel digital input (Dry Contact)
tPET-P6	Tiny Ethernet module with PoE and 6-channel digital input (Wet Contact)
tPET-PD6	Tiny Ethernet module with PoE and 6-channel digital input (Dry Contact)

DC Digital Output	
tET-C4	Tiny Ethernet module with 4-channel digital output (NPN, Sink)
tET-A4	Tiny Ethernet module with 4-channel digital output (PNP, Source)
tPET-C4	Tiny Ethernet module with PoE and 4-channel digital output (NPN, Sink)
tPET-A4	Tiny Ethernet module with PoE and 4-channel digital output (PNP, Source)

DC Digital Input and Output	
tET-P2C2	Tiny Ethernet module with 2-channel digital input and 2-channel digital output (NPN, Sink)
tET-P2A2	Tiny Ethernet module with 2-channel digital input and 2-channel digital output (PNP, Source)
tPET-P2C2	Tiny Ethernet module with PoE, 2-channel digital input and 2-channel digital output (NPN, Sink)
tPET-P2A2	Tiny Ethernet module with PoE, 2-channel digital input and 2-channel digital output (PNP, Source)

Power Relay Output	
tET-P2R2	Tiny Ethernet module with 2-channel digital input(Wet Contact) and 2-channel Form A power relay output
tET-PD2R1	Tiny Ethernet module with 2-channel digital input(Dry Contact) and 1-channel Form A power relay output
tPET-P2R2	Tiny Ethernet module with PoE, 2-channel digital input(Wet Contact) and 2-channel Form A power relay output
tPET-PD2R1	Tiny Ethernet module with PoE, 2-channel digital input(Dry Contact) and 1-channel Form A power relay output
PETL-7060	Ethernet module with 6-channel digital input(Wet Contact) and 6-channel Form A power relay output

PhotoMOS Relay Output	
tET-P2POR2	Tiny Ethernet module with 2-channel digital input(Wet Contact) and 2-channel Form A PhotoMOS relay output
tET-PD2POR2	Tiny Ethernet module with 2-channel digital input(Dry Contact) and 2-channel Form A PhotoMOS relay output
tPET-P2POR2	Tiny Ethernet module with PoE, 2-channel digital input(Wet Contact) and 2-channel Form A PhotoMOS relay output
tPET-PD2POR2	Tiny Ethernet module with PoE, 2-channel digital input(Dry Contact) and 2-channel Form A PhotoMOS relay output

1.1.2 Selection Guide

Model		I/O Specifications			Ethernet 10/100 M	Modbus TCP
Ethernet	PoE	D/I (Type)	D/O (Type)	Isolation		
tET-P6	tPET-P6	6-channel (Wet Contact)	-	Yes	Yes	Yes
tET-PD6	tPET-PD6	6-channel (Dry Contact)	-			
tET-C4	tPET-C4	-	4-channel (Sink)			
tET-A4	tPET-A4	-	4-channel (Source)			
tET-P2C2	tPET-P2C2	2-channel (Wet Contact)	2-channel (Sink)			
tET-P2A2	tPET-P2A2	2-channel (Wet Contact)	2-channel (Source)			
tET-P2POR2	tPET-P2POR2	2-channel (Wet Contact)	2-channel Form A PhotoMos Relay			
tET-PD2POR2	tPET-PD2POR2	2-channel (Dry Contact)	2-channel Form A PhotoMos Relay			
tET-P2R2	tPET-P2R2	2-channel (Wet Contact)	2-channel Form A Relay			
tET-PD2R1	tPET-PD2R1	2-channel (Dry Contact)	1-channel Form A Relay			
-	PETL-7060	6-channel (Wet Contact)	6-channel Form A Relay			

1.1.3 Comparison of PETL/tET/tPET Module

The tPET and PETL-7060 series features true IEEE 802.3af-compliant (classification, Class 1) Power over Ethernet (PoE) functions. Now, not only can data be carried through an Ethernet cable, but power can also be provided. This feature makes installation of tPET series modules a straightforward task. Imagine no more unnecessary wires with only an Ethernet cable required in order to take care of everything in the field.

The tET/tPET and PETL-7060 series also features a built-in web server that allows basic configuration, I/O monitoring and I/O control to be performed by simply using a web browser meaning that remote control of your modules is as easy as surfing the Internet. In addition, tET/tPET and PETL-7060 series modules support the Modbus TCP/UDP protocols, ensuring perfect integration with SCADA software.

Industrial PoE Solutions

When using PoE devices such as the tPET series, you can incorporate the ICP DAS “PoE” switch, the “NS-205PSE”, as the power source. The NS-205PSE automatically detects any connected devices, whether they are PoE devices or not. This mechanism ensures that the NS-205PSE will function simultaneously with both PoE and non-PoE devices.

Note that when acting as a power source for a PoE device, the NS-205PSE requires a power input ranging from +46 V_{DC} to +55 V_{DC}.



More Information

All tET series modules can only be powered using a +12 V_{DC} to +48 V_{DC} power supply connected through a removable terminal block.

In contrast, tPET and PETL-7060 series modules offer two methods of supplying power. The first is through the Ethernet via a PoE switch; the second is through a removable terminal block via an external power source. The external power supply should be in the range of +12 V_{DC} to 48 V_{DC}. The reason for including the second method is to provide a redundant power input feature. tPET and PETL-7060 series modules also indicate an LED that indicates whether the power is being supplied by the PoE switch or not.

	tPET	PETL-7060	PET-7000
CPU	32-bit ARM		80186
Ethernet	10/100 M, PoE		
Modbus TCP/UDP	Yes		
Web Configuration	Yes		
Web HMI	Simplified		Yes
Multi-client	Yes (Max. Connections: 5)		Yes (Max. Connections: 12)
IP Filter	Yes (white list)		
Latched DI	Yes		
DI as Counter	32-bit, 3.5 kHz		32-bit, 500 Hz
Frequency Measurement	Yes (3.5 kHz Max.)		-
I/O Pair-connection	Yes (Poll/Push Mode)		Yes (Poll Mode)
PWM	Yes (100 Hz Max.)		-
Dual-Watchdog	Yes (CPU, Host)		Yes (Module, Host)
ESD Protection	+/- 4 kV		
Surge Protection	-	+/- 0.5 kV	
Form Factor	Tiny Size		Palm Size
Remarks	Cost-effective		-
Note: tET = tPET without PoE functionality.			

1.2 Features

➤ Built-in Web Server

Each tET/tPET/PETL series module contains a built-in web server that allows users to easily configure, monitor and control the module from a remote location using a web browser.



➤ Modbus Protocol

The Modbus TCP/UDP slave function on the Ethernet port can be used to provide data to remote SCADA software.

➤ All-in-one Module

A variety of I/O components are available on multiple channels in a single module, which provides the most cost effective I/O usage and enhances the performance of I/O operations.

➤ Automatic MDI/MDI-X Detection for Plug-and-Play

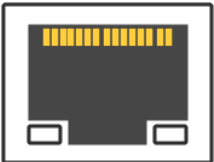

The RJ-45 port supports automatic sensing of MDI/MDI-x switching that can automatically detect the type of connection being used by the Ethernet device without requiring special straight or crossover cables.

➤ Built-in Dual Watchdog

The Dual Watchdog consists of a CPU Watchdog (for hardware functions) and a Host Watchdog (for software functions).

The **CPU Watchdog** will automatically reset it-self if the built-in firmware encounters an abnormal situation.



If there is no communication between the module and the host (PC or PLC) for a specified period of time (i.e., the Watchdog timeout), the **Host Watchdog** will set the digital output based on a predefined safe-value.

➤ Built-in Multi-Function I/O

1. All **Digital Output** modules provide:

- A **Power-on Value** (On boot up, the digital output value is set as the Power-on value)
- A **Safe Value** (If Modbus TCP communication is lost for a certain period, the digital output Value will be set as the user-defined safe value)
- A **PWM Function**: The digital output channels on PETL/tET/tPET series include a PWM (pulse generation) function that can be used to set different frequencies (50 or 100 Hz Max.) and duty cycles for each digital output channel. In addition, the two digital output channels can work either independently or simultaneously. The term “High Duty Cycle” describes the duration of 'on' time in proportion to the regular interval or 'period' of time. Similarly, the term “Low Duty Cycle” corresponds to the duration of the 'off' time. Consequently, it is not necessary to keep switching from ON to OFF from remote a controller. In this way, the tET/tPET/PETL series module reduces the complexity required for the control system and enhances timing accuracy.

2. All **Digital Input** modules provide:

- **Digital input channels that can also be used as 32-bit high speed (3.5 kHz) counters.**
- **High/Low Latched Status Commands**: The modules provide commands to read the status of any digital input channels that are latched high or latched low. The following is an example that shows the usefulness of the latched digital input. If we wish to read a key stroke from a key switch connected to the digital input channel of a module, the input signal of the key stroke is a pulse signal as shown in the figure.

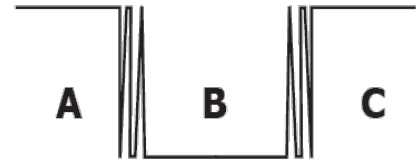

If we just use the read digital input status command to read the signal and we cannot send the command during the B period due to some reasons, then we will lose the key stroke information. However, with the read latched digital input command, we can still get the key stroke information even we are not able to send command in B period.

- **Frequency Measurement**: tET/tPET/PETL series modules also provide a frequency measurement function that retrieves the digital input counter value at specific times and calculates the frequency. Rather than polling via a remote host, the tET/tPET/PETL series modules can determine the frequency directly, reducing the communication delay caused by two ends and also improves the accuracy of the frequency measurement. In order to applying for more applications, this module provides 3 scan modes and 4 moving average methods for user to select the best way in their applications.

➤ I/O Pair-Connection

The I/O Pair-connection function is used to create a digital input to digital output pair through the Ethernet. Once the configuration is complete, the PETL/tET/tPET series modules can continuously poll the status of a remote digital input device using the Modbus TCP protocol, and then write to the local digital output channels in the background.

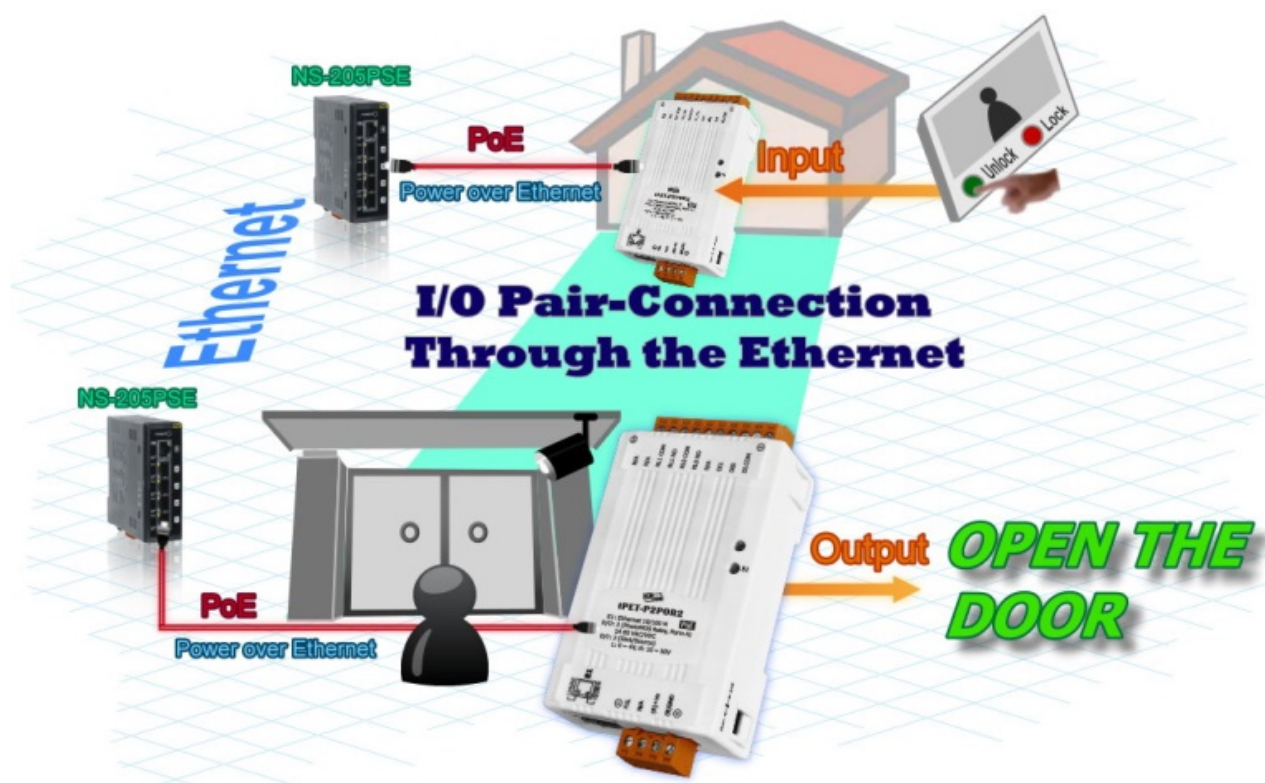

2. Hardware Information

2.1 Front and Back Panel

The following is a brief overview and description of the components included in PETL/tET/tPET series modules.

PETL-7060



tET/tPET Series

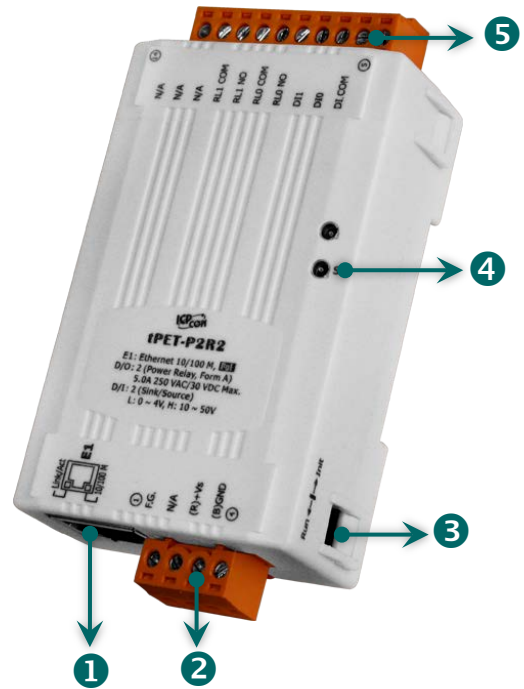

1	Ethernet Port	4	System LED Indicator
2	J1 Connector	5	J2 Connector
3	Operating Mode Switch		

Ethernet Port

The PETL/tET/tPET series module are equipped with an RJ-45 jack that is used as the 10/100 Base-TX Ethernet port and features networking capability. When an Ethernet link is detected and an Ethernet packet is received, the **Link/Act LED (Green)** indicator and the **10/100 M LED (Yellow)** indicator will be illuminated.

Note

The Ethernet port supports PoE (Power-over-Ethernet) functions for PETL/tPET series modules only.



J1 Connector

The type of J1 connector used depends on the type of PETL/tET/tPET series module. For more detailed information regarding the pin assignments for the J1 Connector, please refer to [Section 2.3 “Pin Assignments”](#).

➤ **DC Power Input:**

The definition for “(R)+Vs” and “(B)GND” for use as the power supply applies to all types of PETL/tET/tPET series module.

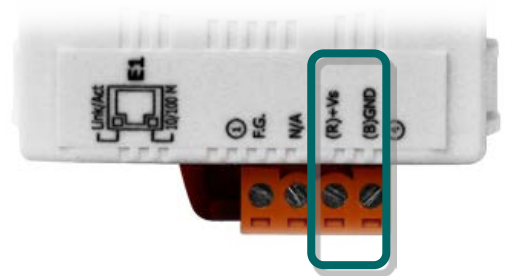

Module	Pin	Name	Function
PETL-7060	8	(R)+Vs	+12 to +48 V _{DC} Power Input
	9	(B)GND	Ground Connection
tET/tPET	3	(R)+Vs	+12 to +48 V _{DC} Power Input
	4	(B)GND	Ground Connection

➤ **Frame Ground:**

Electronic circuits are constantly vulnerable to Electrostatic Discharge (ESD), which becomes worse in a continental climate area. PETL/tET/tPET series module feature a new design for the frame ground, which provides a path that bypasses ESD, resulting in an enhanced ESD protection capability and ensuring that the module is more reliable.

✓ **The frame ground (F.G.) of the tET/tPET series, as follows:**

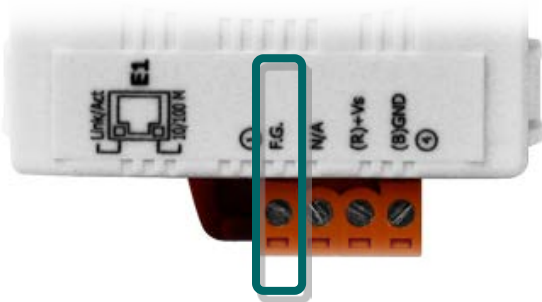

Module	Pin	Name	Function
tET/tPET	1	F.G.	Frame Ground

✓ **The frame ground (F.G.) of the PETL-7060, as follows:**

The PETL-7060 controller has a metallic board attached to the back of the plastic casing as indicated by point 1 in the figure.

When mounted to the DIN-Rail, connect the DIN-Rail to the earth ground because the DIN-Rail is in contact with the upper frame ground as shown in the figure, point 2.

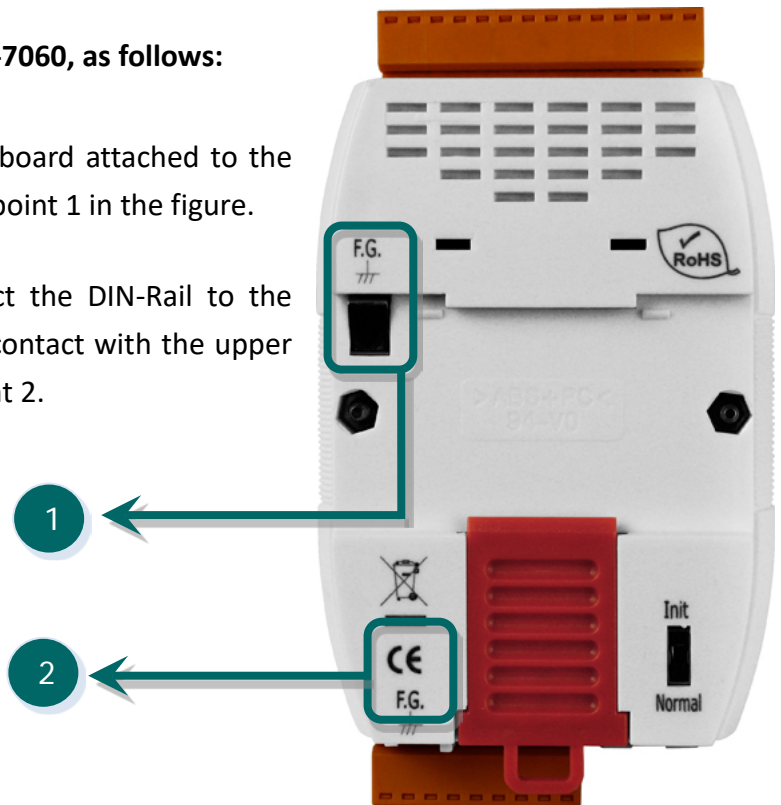

Operating Mode Switch

- **Init mode:** Uses factory settings and allows the firmware to be updated.
- **Run/Normal mode:** Uses customer settings.

The operating mode switch for PETL/tET/tPET series modules is set to the **Run/Normal** position by default. When updating the PETL/tET/tPET firmware, the switch should be moved from the **Run/Normal** position to the **Init** position. The switch must then be returned to the **Run/Normal** position once the update is complete.

 **Note**

The module must be rebooted after changing operating.

PETL-7060



tET/tPET Series



System LED Indicator

Once power is supplied to the PETL/tET/tPET series module, the LED indicator will be illuminated as follows:

tET/tPET Series	
Function	System LED Behavior
Running Firmware	ON (Red)
Network Ready	Flashing once every 3 seconds (Red)
PoE (for tPET only)	ON (Green)

PETL-7060		
Name	Function	System LED Behavior
L1	Running Firmware	ON (Red)
L2	Link/ACT (Red)	ON: Ethernet link detected OFF: No Ethernet link detected Flashing: Ethernet packet received
L3	10/100M(Yellow)	OFF: the speed is 10 Mbps ON: the speed is 100 Mbps
PoE	Supply power	ON (Green)

Note

The PoE LED (Green) indicator is only applicable to PETL/tPET series modules.

J2 Connector

The J2 connector depends on the type of the PETL/tET/tPET series module. For more detailed information regarding the pin assignments for the J2 Connector, refer to [Section 2.3 “Pin Assignments”](#).

2.2 Specifications

2.2.1 System Specifications

Modules	tET Series	tPET Series	PETL-7060
System			
CPU	32-bit MCU		
Dual Watchdog	Yes		
Communication			
Ethernet Port	10/100 Base-TX, 8-Pin RJ-45 x1, (Auto-negotiating, Auto-MDI/MDIX, LED Indicator)		
	-	PoE (IEEE 802.3af, Class 1)	
LED Display			
PoE Indicator	-	S1 (Green)	PoE (Green)
System Indicator	S1 (Red)		L1 (Red)
Link/Act Indicator	E1 (Green)		L2 (Red)
10/100 M Indicator	E1 (Yellow)		L3 (Yellow)
Mechanical			
Dimensions (W x H x D)(mm)	52 x 27 x 98		123 x 72 x 35
Installation	DIN-Rail mounting		DIN-Rail or Wall mounting
Environment			
Operating Temperature	-25 °C ~ +75 °C		
Storage Temperature	-30 °C ~ +80 °C		
Humidity	10 ~ 90 % RH, non-condensing		
Power Requirements			
Power Input	-	PoE: IEEE 802.3af, Class 1	
	Terminal Block: +12 ~ 48 V _{DC} (non-regulated)		
Power Consumption	0.04 A @ 24 V _{DC} for tET-P2R2	0.03 A @ 48 V _{DC} for tPET-P2R2	0.05 A @ 48 V _{DC}

2.2.2 I/O Specifications

tET-P6/tPET-P6/tET-PD6/tPET-PD6

Models		tET-P6 tPET-P6	tET-PD6 tPET-PD6
Digital Input			
Input Channels		6	
Input Type (Device)		Wet Contact (Sink, Source)	Dry Contact (Source)
On Voltage Level		+10 V _{DC} ~ +50 V _{DC}	Close to GND
Off Voltage Level		+4 V _{DC} max.	Open
Input Impedance		10 kΩ	-
Counters	Max. Count	4,294,967,285 (32 bits)	
	Min. Pulse Width	0.15 ms	
Frequency Measurement		3.5 kHz (without filter)	
Overvoltage Protection		+70 V _{DC}	-
Isolation		3750 V _{rms}	
Effective Distance		-	500 M Max.

tET-C4/tPET-C4/tET-A4/tPET-A4

Models		tET-C4 tPET-C4	tET-A4 tPET-A4
Digital Output			
Output Channels		4	
Output Type (Module)		Sink, Open Collector (NPN)	Source, Open Collector (PNP)
Output Voltage		+5 V _{DC} ~ +30 V _{DC}	+10 V _{DC} ~ +40 V _{DC}
Max. Load Current		100 mA/channel	650 mA/channel
PWM		100 Hz Max. (The High/Low duty cycle range = 5 ~ 65,535 ms)	
Over-Voltage		+60 V _{DC}	+48 V _{DC}
Short Circuit Protection		-	Yes
Output Isolation		3750 V _{rms}	

tET-P2C2/tPET-P2C2/tET-P2A2/tPET-P2A2

Models	tET-P2C2 tPET-P2C2	tET-P2A2 tPET-P2A2
Digital Input		
Input Channels	2	
Input Type (Device)	Wet Contact (Sink, Source)	
On Voltage Level	+10 V _{DC} ~ +50 V _{DC}	
Off Voltage Level	+4 V _{DC} Max.	
Input Impedance	10 kΩ	
Counters	Max. Count: 4,294,967,285 (32 bits)	
	Min. Pulse Width: 0.15 ms	
Frequency Measurement	3.5 kHz (without filter)	
Oversvoltage Protection	+70 V _{DC}	
Isolation	3750 V _{rms}	
Digital Output		
Output Channels	2	
Output Type (Module)	Sink, Open Collector (NPN)	Source, Open Collector (PNP)
Output Voltage	+5 V _{DC} ~ +30 V _{DC}	+10 V _{DC} ~ +40 V _{DC}
Max. Load Current	100 mA/channel	650 mA/channel
PWM	100 Hz Max. (The High/Low duty cycle Range = 5 ~ 65,535 ms)	
Over-Voltage	+60 V _{DC}	+48 V _{DC}
Short Circuit Protection	-	Yes
Output Isolation	3750 V _{rms}	

tET-P2POR2/tPET-P2POR2/tET-PD2POR2/tPET-PD2POR2

Models		tET-P2POR2 tPET-P2POR2	tET-PD2POR2 tPET-PD2POR2
Digital Input			
Input Channels		2	
Input Type (Device)		Wet Contact (Sink, Source)	Dry Contact (Source)
On Voltage Level		+10 V _{DC} ~ +50 V _{DC}	Close to GND
Off Voltage Level		+4 V _{DC} Max.	Open
Input Impedance		10 kΩ	-
Counters	Max. Count	4,294,967,285 (32 bits)	
	Min. Pulse Width	0.15 ms	
Frequency Measurement		3.5 kHz (without filter)	
Overvoltage Protection		+70 V _{DC}	-
Isolation		3750 V _{rms}	
Effective Distance		-	500 M Max.
Relay Output			
Output Channels		2	
Output Type (Module)		PhotoMOS Relay, Form A	
Load Voltage		60 V _{DC} / V _{AC}	
Load Current	60 V/1.0 A (Operating Temperature -25°C ~ -40°C)		
	60 V/0.8 A (Operating Temperature +40°C ~ +60°C)		
	60 V/0.7 A (Operating Temperature +60°C ~ +75°C)		
PWM		100 Hz max. (The High/Low duty cycle range = 5 ~ 65,535 ms)	
Turn ON Time		1.3 ms (Typical)	
Turn Off Time		0.1 ms (Typical)	
Output Isolation		3000 V _{rms}	

Note

Because of the characteristics of the relay functions, it is recommended that the PWM on t(P)ET-P(D)2POR2/ t(P)ET-P2R2/ t(P)ET-PD2R1/ PETL-7060 series modules (i.e., modules with relay functions) is not used for extended periods of time.

tET-P2R2/tPET-P2R2/tET-PD2R1/tPET-PD2R1

Models		tET-P2R2 tPET-P2R2	tET-PD2R1 tPET-PD2R1
Digital Input			
Input Channels		2	
Input Type (Device)		Wet Contact (Sink, Source)	Dry Contact (Source)
On Voltage Level		+10 V _{DC} ~ +50 V _{DC}	Close to GND
Off Voltage Level		+4 V _{DC} Max.	Open
Input Impedance		10 kΩ	-
Counters	Max. Count	4,294,967,285 (32 bits)	
	Min. Pulse Width	0.15 ms	
Frequency Measurement		3.5 kHz (without filter)	
Overvoltage Protection		+70 V _{DC}	-
Isolation		3750 V _{rms}	
Effective Distance		-	500 M Max.
Relay Output			
Output Channels		2	1
Output Type (Module)		Power Relay, Form A (SPST N.O.)	
Output Voltage Range		250 V _{AC} /30 V _{DC}	
Max. Load Current		5.0 A/channel	
Operate Time		6 ms	
Release Time		3 ms	
PWM		50 Hz max. (The High/Low duty cycle range = 10 ~ 65,535 ms)	
Electrical Life (Resistive load)	VED	5 A 250 V _{AC} 30,000 ops (10 ops/minute) at 75 °C	
		5 A 30 V _{DC} 70,000 ops (10 ops/minute) at 75 °C	
	UL	5 A 250 V _{AC} /30 V _{DC} 6,000 ops	
		3 A 250 V _{AC} /30 V _{DC} 100,000 ops	
Mechanical Life		20,000,000 ops. At no load (300 ops./ minute)	
Output Isolation		3000 V _{rms}	

Note

Because of the characteristics of the relay functions, it is recommended that the PWM on t(P)ET-P(D)2POR2/ t(P)ET-P2R2/ t(P)ET-PD2R1/ PETL-7060 series modules (i.e., modules with relay functions) is not used for extended periods of time.

PETL-7060

Models		PETL-7060
Digital Input		
Input Channels		6
Input Type (Device)		Wet Contact (Sink, Source)
On Voltage Level		+10 V _{DC} ~ +50 V _{DC}
Off Voltage Level		+4 V _{DC} Max.
Input Impedance		10 kΩ
Counters	Max. Count	4,294,967,285 (32 bits)
	Min. Pulse Width	0.15 ms
Frequency Measurement		3.5 kHz (without filter)
Overvoltage Protection		+70 V _{DC}
Isolation		3750 V _{rms}
Relay Output		
Output Channels		6
Output Type (Module)		Power Relay, Form A (SPST N.O.)
Output Voltage Range		250 V _{AC} /30 V _{DC}
Max. Load Current		5.0 A/channel
Operate Time		6 ms
Release Time		3 ms
PWM		50 Hz max. (The High/Low duty cycle range = 10 ~ 65,535 ms)
Electrical Life (Resistive load)	VED	5 A 250 V _{AC} 30,000 ops (10 ops/minute) at 75 °C
		5 A 30 V _{DC} 70,000 ops (10 ops/minute) at 75 °C
	UL	5 A 250 V _{AC} /30 V _{DC} 6,000 ops
		3 A 250 V _{AC} /30 V _{DC} 100,000 ops
Mechanical Life		20,000,000 ops. At no load (300 ops./ minute)
Output Isolation		3000 V _{rms}

Note

Because of the characteristics of the relay functions, it is recommended that the PWM on t(P)ET-P(D)2POR2/ t(P)ET-P2R2/ t(P)ET-PD2R1/ PETL-7060 series modules (i.e., modules with relay functions) is not used for extended periods of time.

2.3 Pin Assignments

tET-P6/tPET-P6/tET-PD6/tPET-PD6

- : I/O Address Mapping
- : Counter Address Mapping

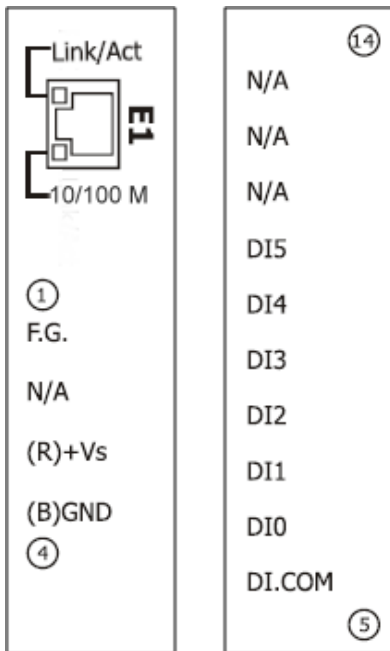
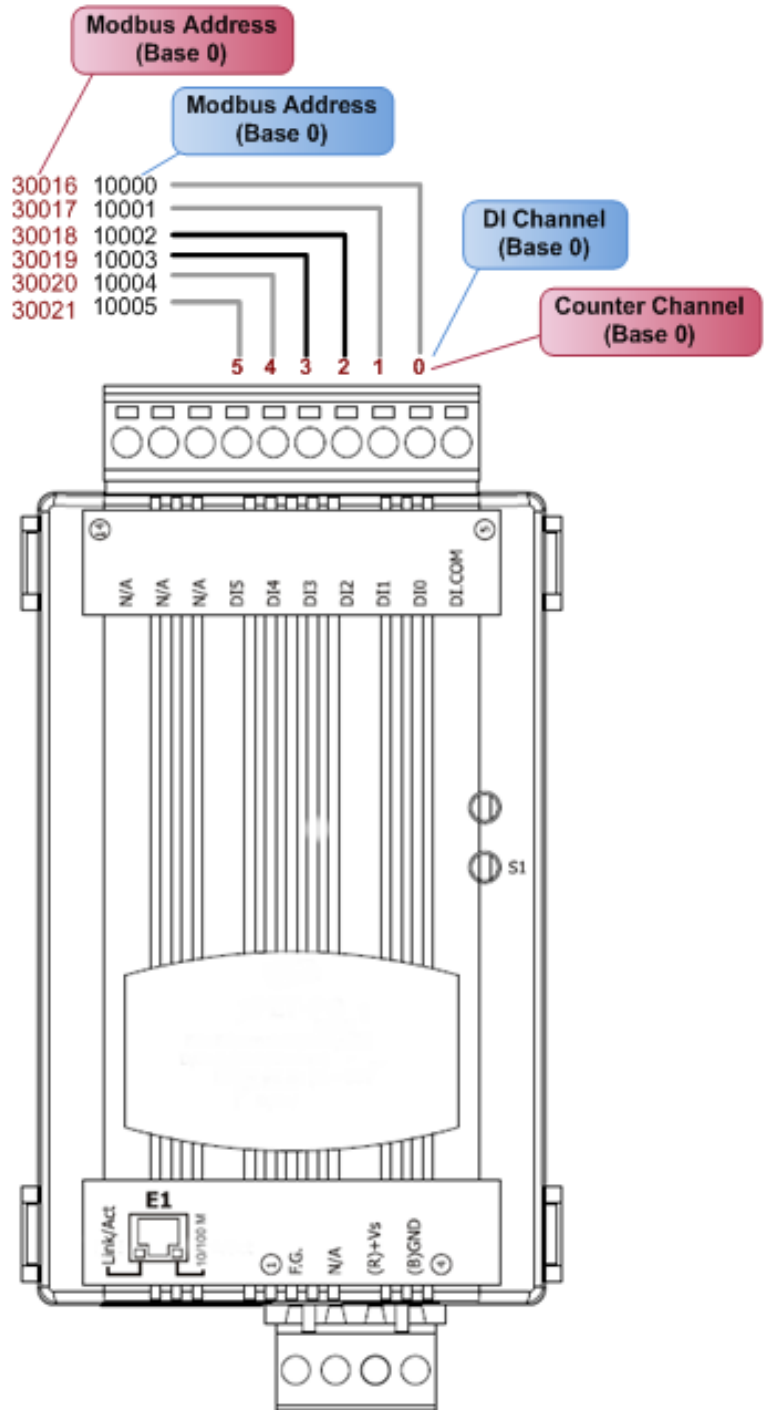

tET-C4/tPET-C4/tET-A4/tPET-A4

 : I/O Address Mapping

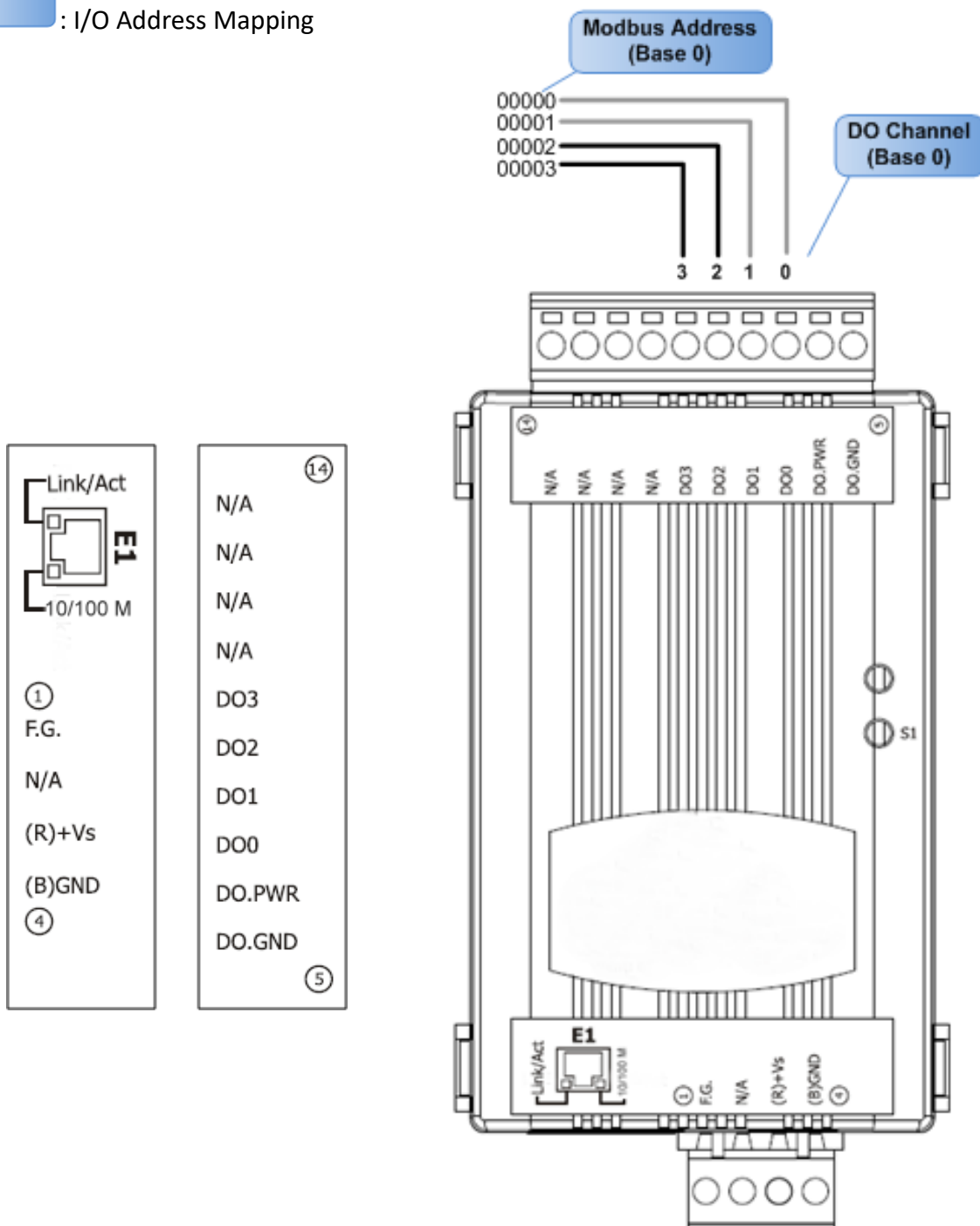

tET-P2POR2/tPET-P2POR2/tET-P2R2/tPET-P2R2

- : I/O Address Mapping
- : Counter Address Mapping

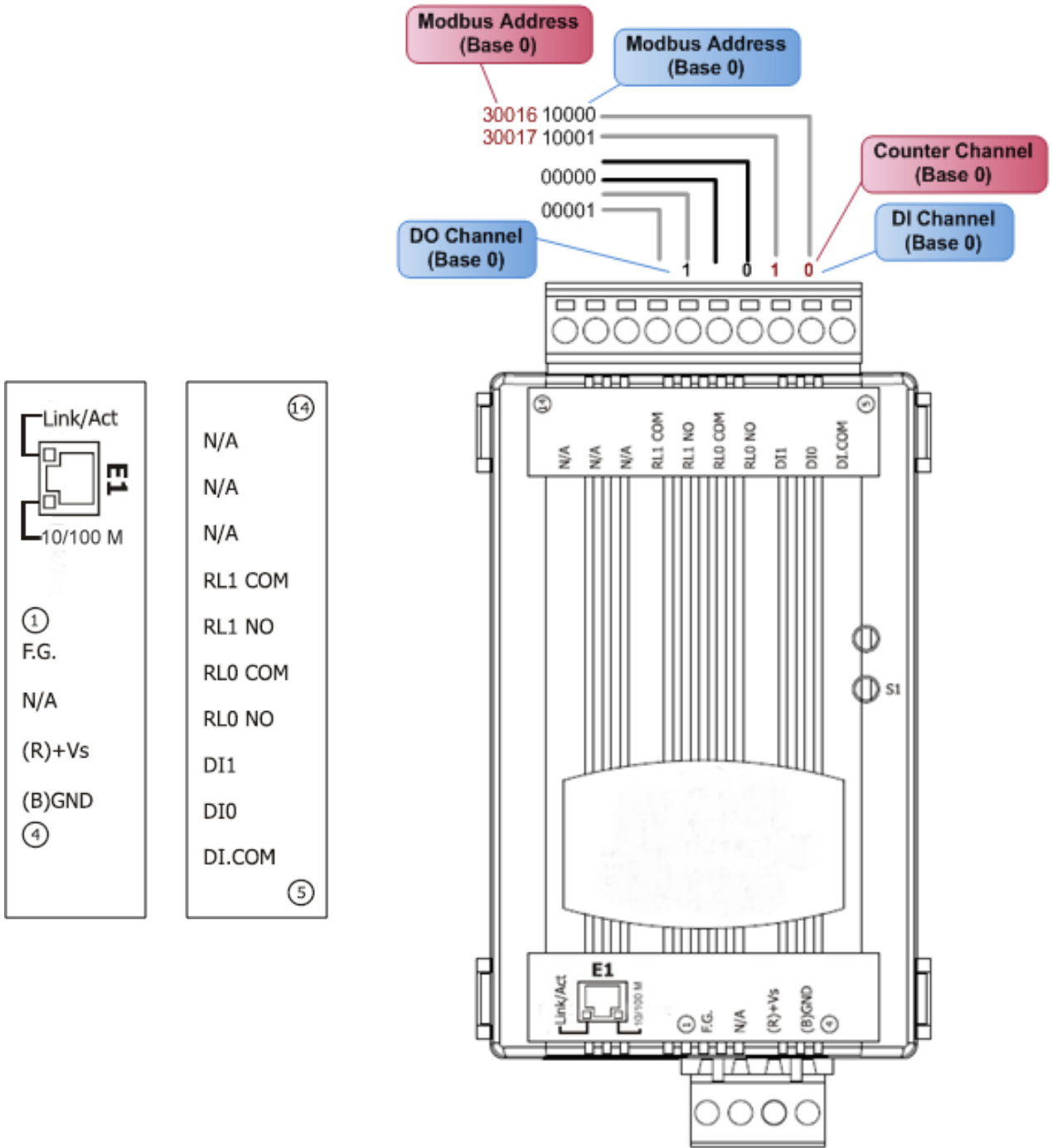

tET-PD2POR2/tPET-PD2POR2

 : I/O Address Mapping

 : Counter Address Mapping

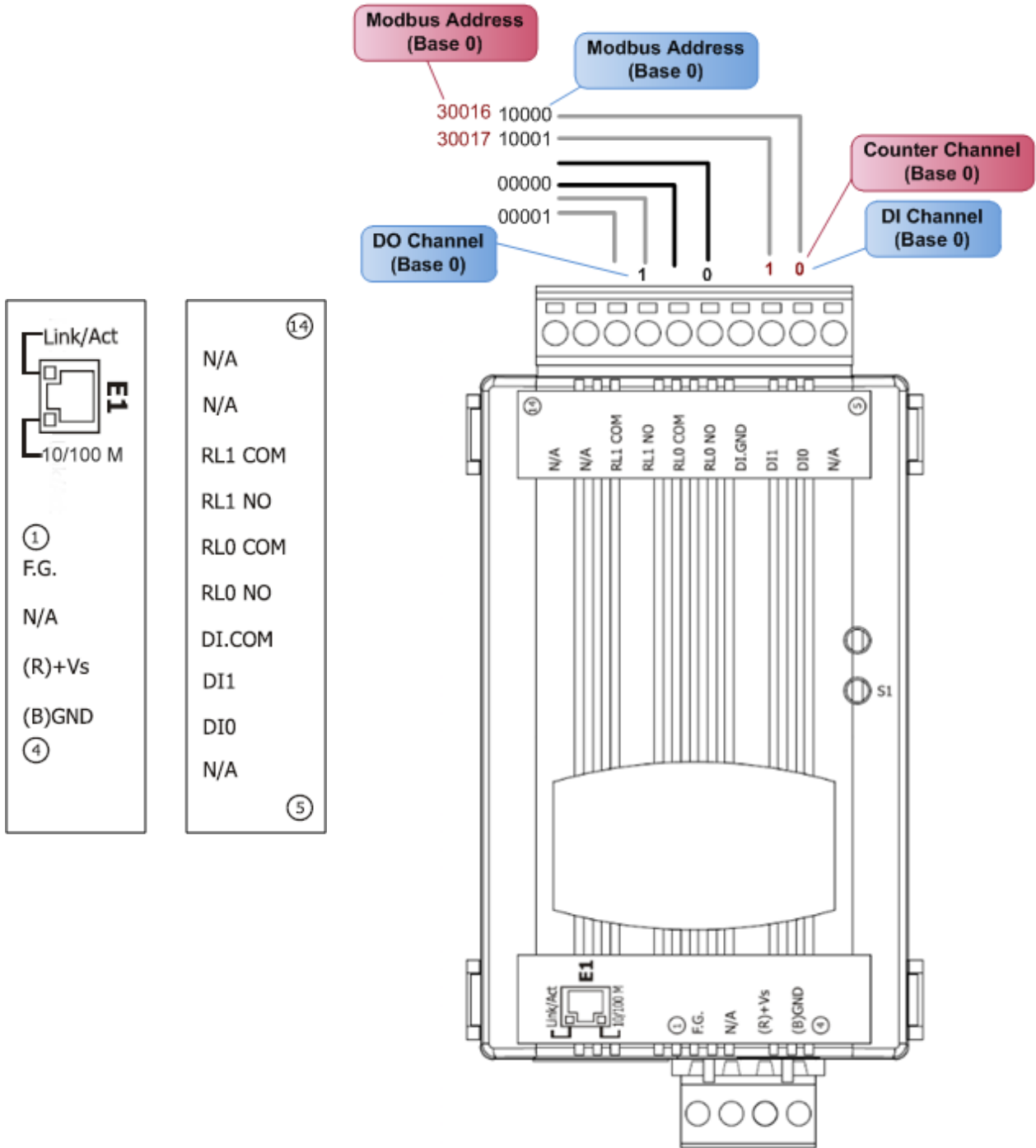

tET-PD2R1/tPET-PD2R1

: I/O Address Mapping
 : Counter Address Mapping

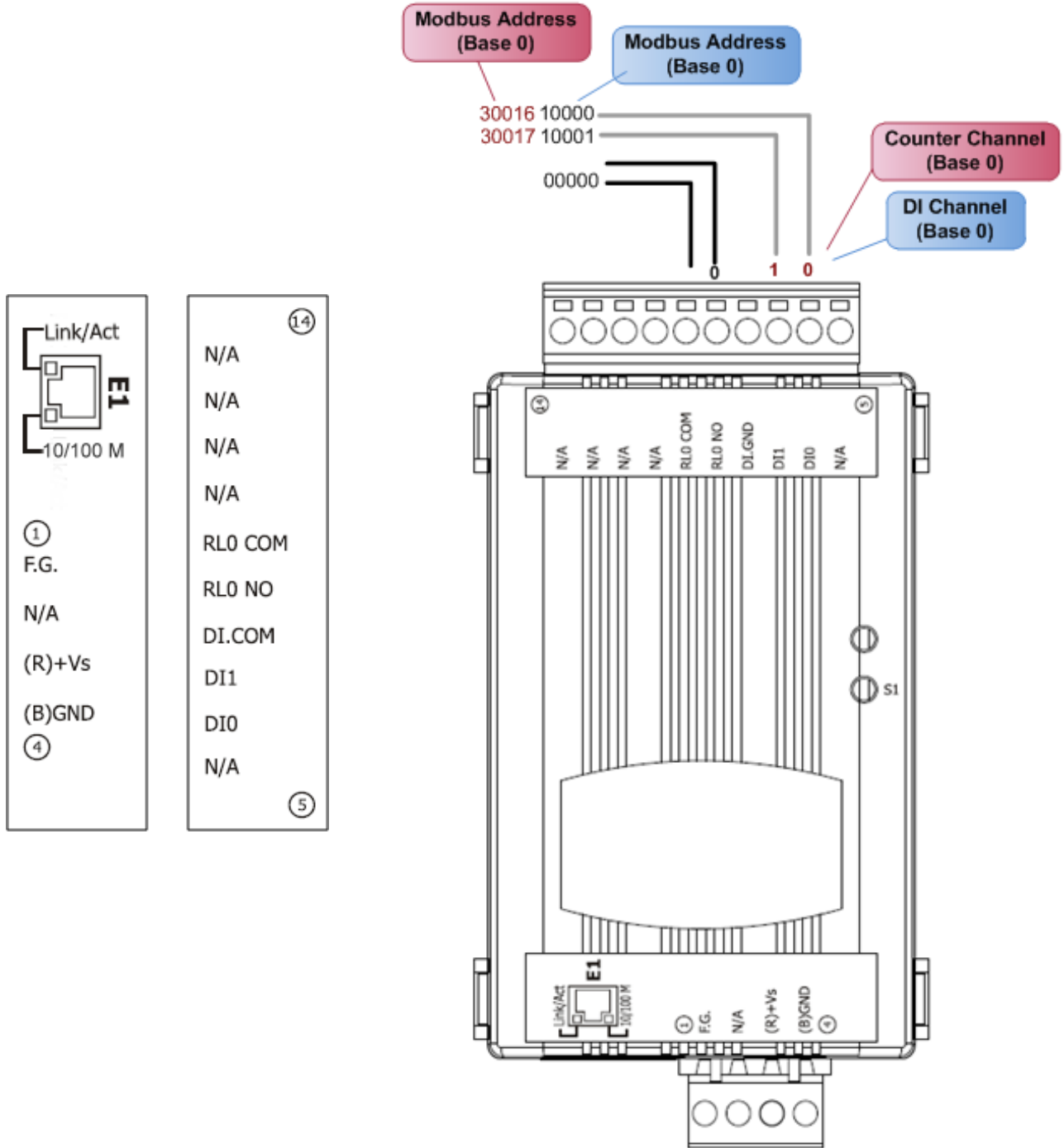

tET-P2C2/tPET-P2C2/tET-P2A2/tPET-P2A2

- : I/O Address Mapping
- : Counter Address Mapping

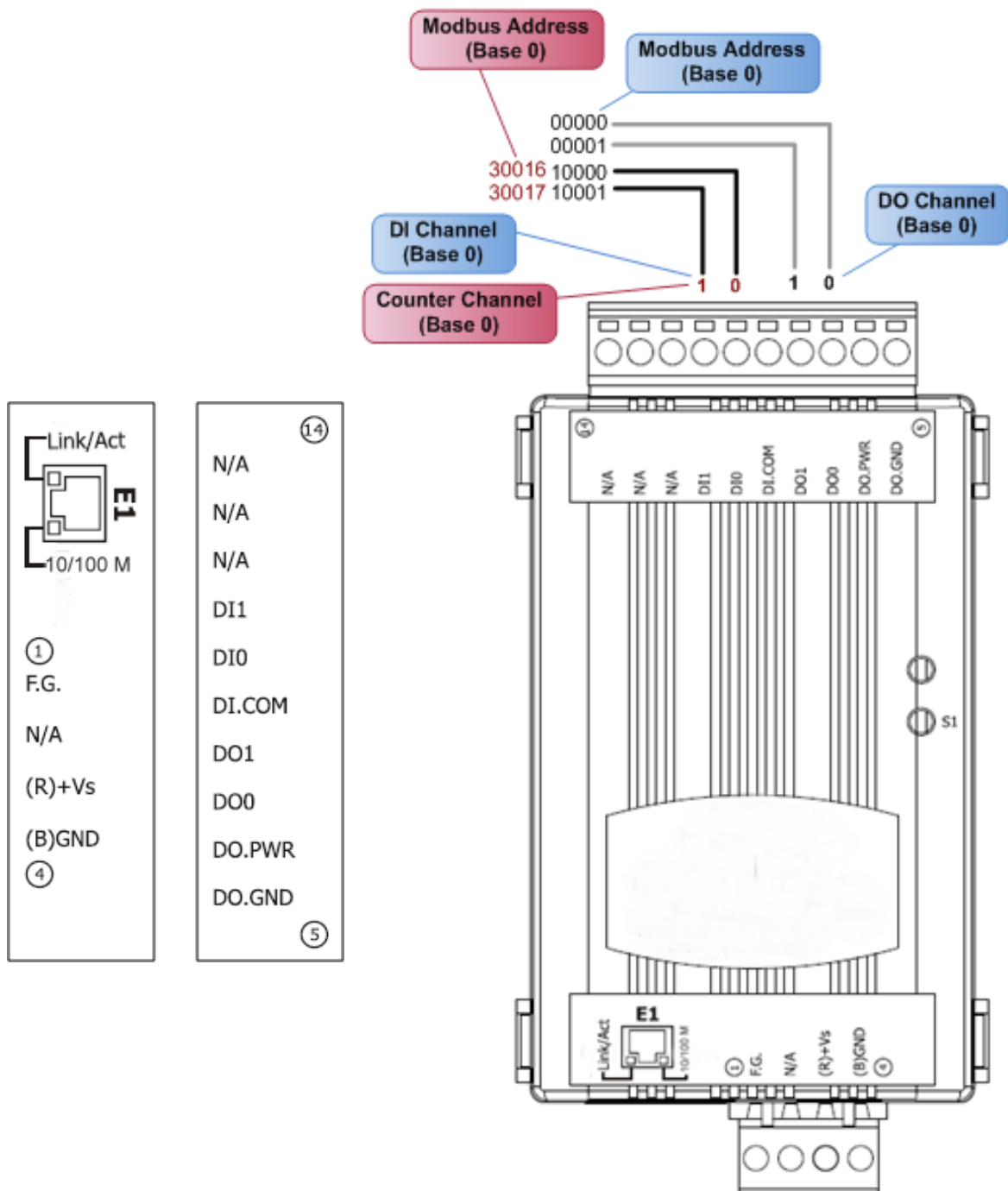

PETL-7060

 : I/O Address Mapping

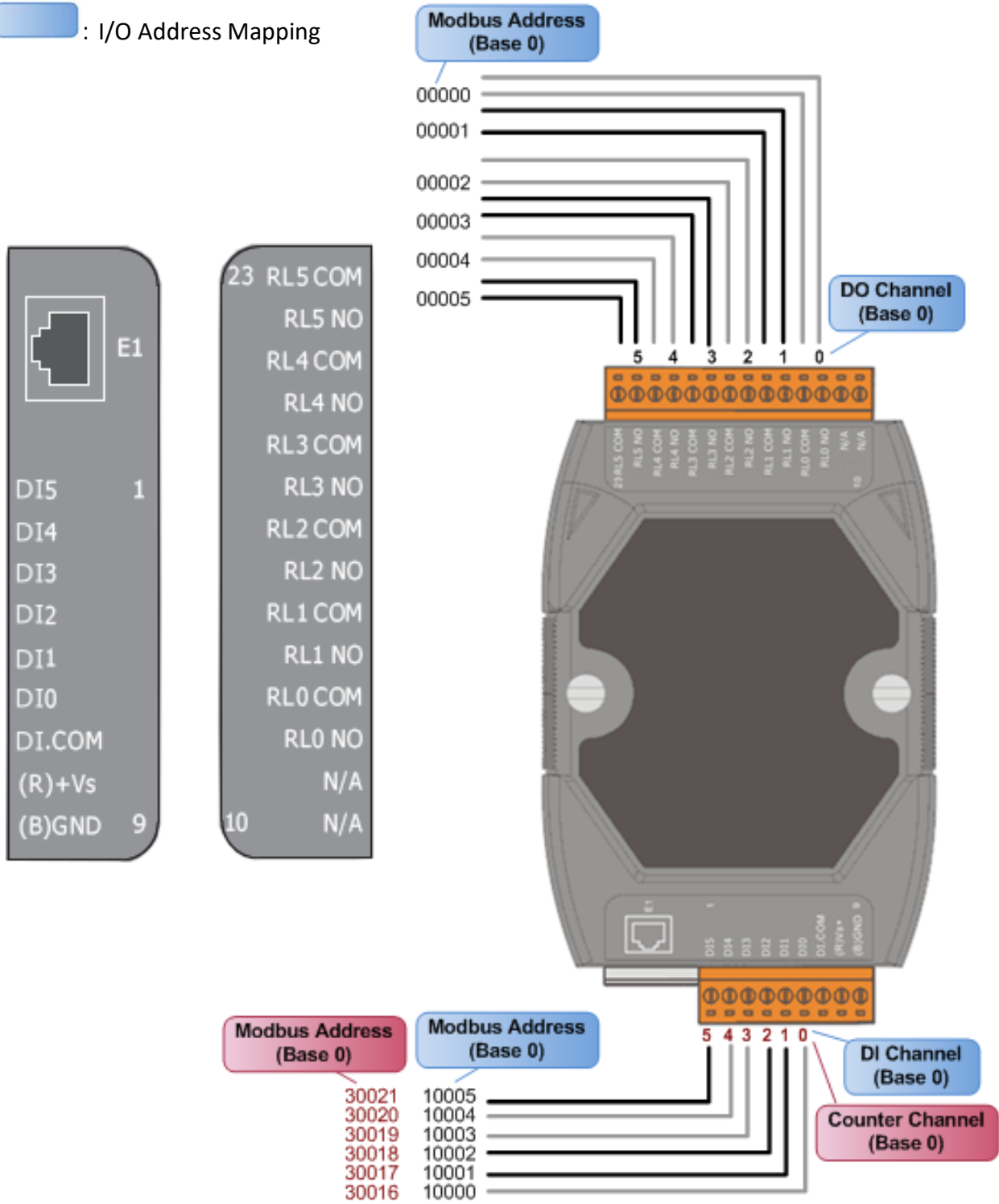

2.4 Wiring Connections

2.4.1 Input Wiring

- **tET-P6/ tPET-P6,tET-P2C2/ tPET-P2C2, tET-P2A2/tPET-P2A2,tET-P2POR2/tPET-P2POR2, tET-P2R2 /tPET-P2R2, PETL-7060**

Input Type	Readback as 1	Readback as 0
Sink	+ 10 ~ +50 V _{DC}	OPEN or <4 V _{DC}
Source	+ 10 ~ +50 V _{DC}	OPEN or <4 V _{DC}

- **tET-PD6/tPET-PD6, tET-PD2POR2/tPET-PD2POR2, tET-PD2R1/tPET-PD2R1:**

Input Type	Readback as 0	Readback as 1
Dry Contact	Relay OFF	Relay ON

2.4.2 Output Wiring

➤ **tET-C4/tPET-C4, tET-P2C2/tPET-P2C2**

Output Type	Readback as 1	Readback as 0
	Relay ON	Relay OFF
Drive Relay		
Resistance Load		

➤ **tET-A4/tPET-A4, tET-P2A2/tPET-P2A2**

Output Type	
ON State Readback as 1	
OFF State Readback as 0	

➤ **tET-P2R2/tPET-P2R2, tET-PD2R1/tPET-PD2R1, PETL-7060**

Output Type	Readback as 1	Readback as 0
Relay Output	Relay ON	Relay OFF

➤ **tET-P2POR2/tPET-P2POR2, tET-PD2POR2/tPET-PD2POR2**

Output Type	Readback as 1	Readback as 0
Form A Relay Contact	Relay ON	Relay OFF

2.5 Dimensions

➤ The PETL-7060 dimensions are in millimeters.

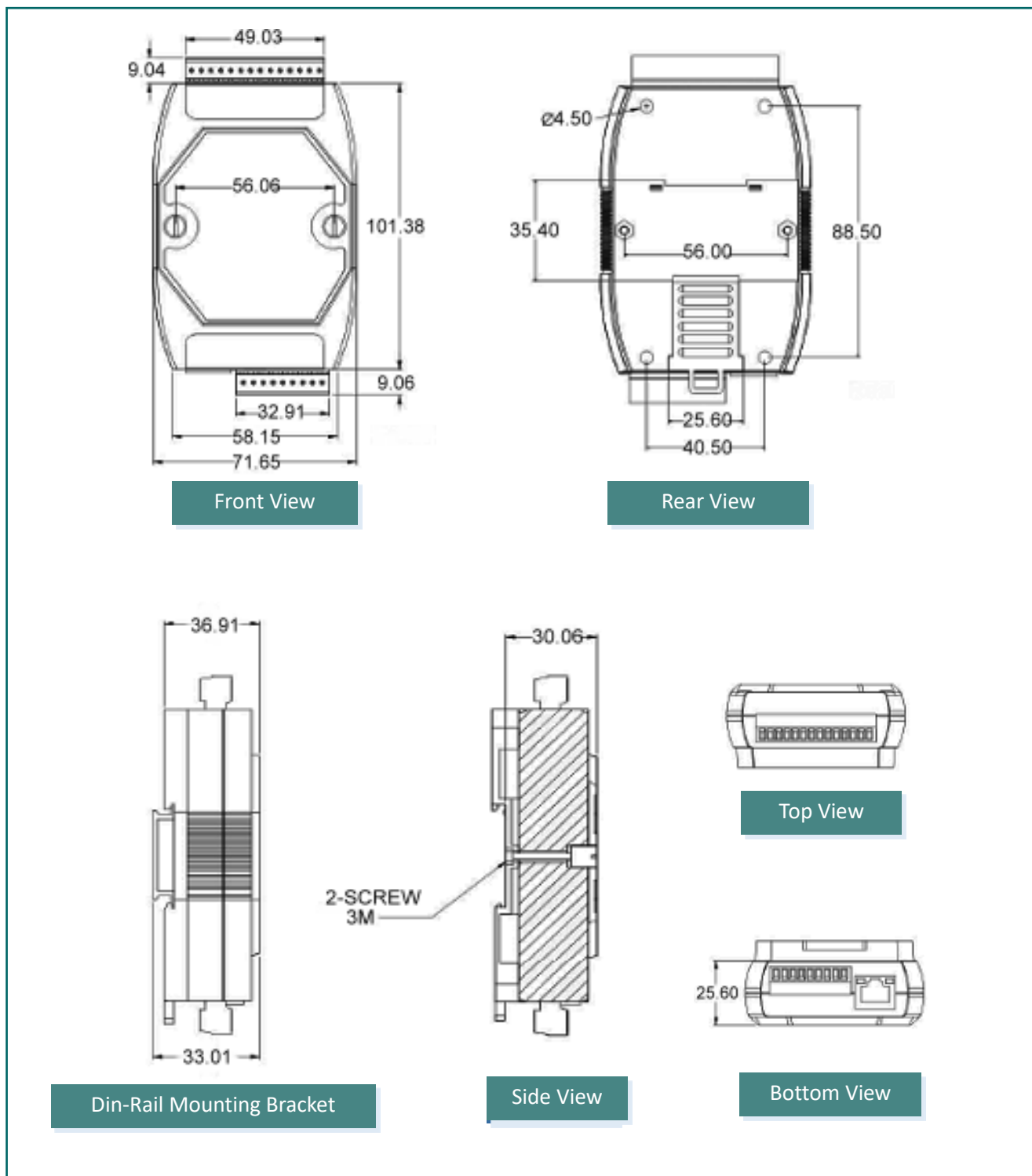

➤ The tET/tPET series dimensions are in millimeters.

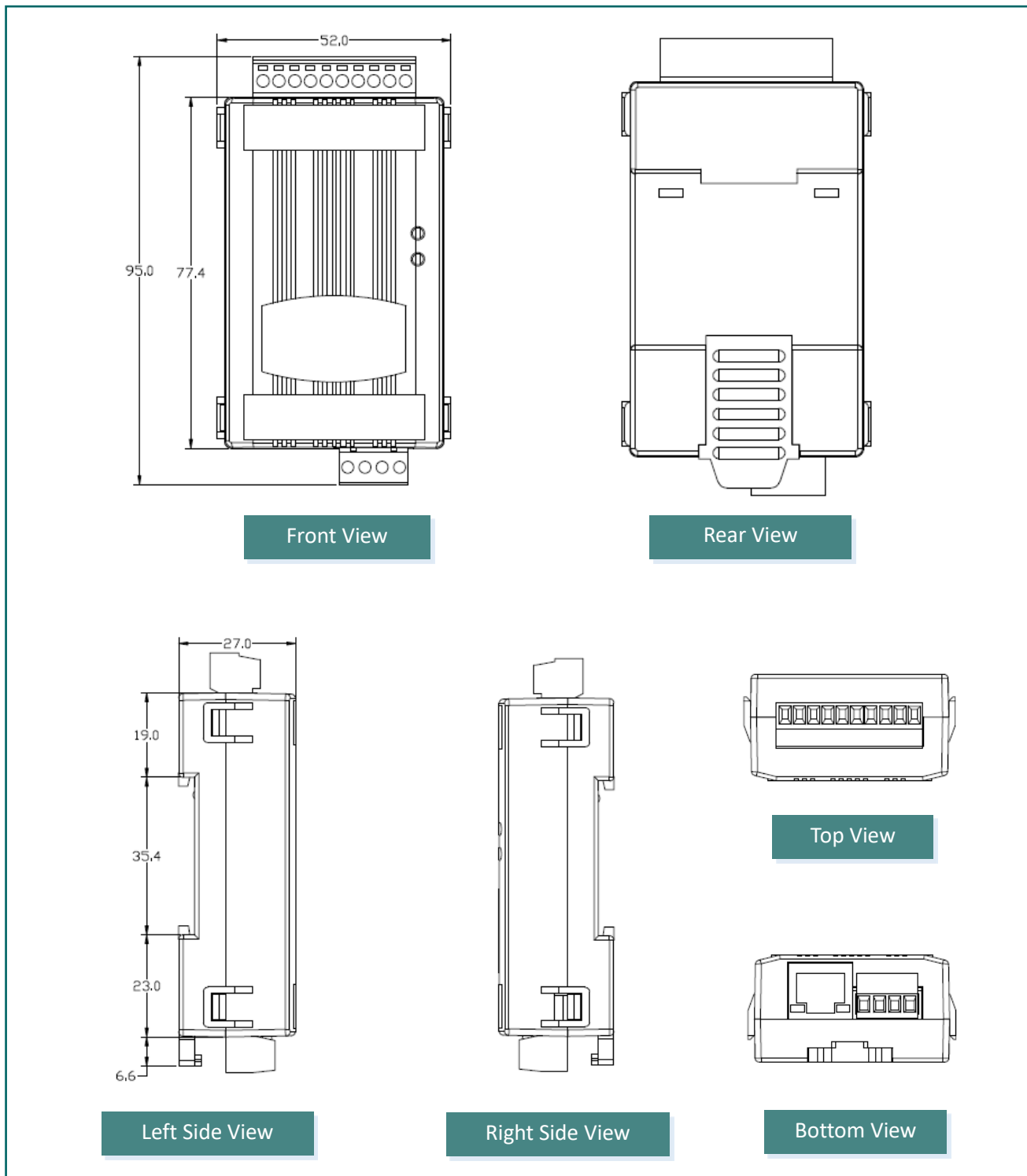

3. Getting Started

This chapter provides a basic overview of how to install, configure and operate your PETL/tET/tPET series module.

3.1 Mounting the Module

The PETL/tET/tPET series module can be mounted by attaching the bottom of the chassis to a DIN-Rail, or the wall or it can be piggybacked to another module.

DIN-Rail Mounting

The PETL/tET/tPET series modules include simple rail clips on the bottom of the chassis that allow them to be reliably mounted on a DIN-Rail or a wall, or they can be piggybacked to another module. For more detailed information regarding DIN-Rail Mounting, refer to the illustration in figure below.

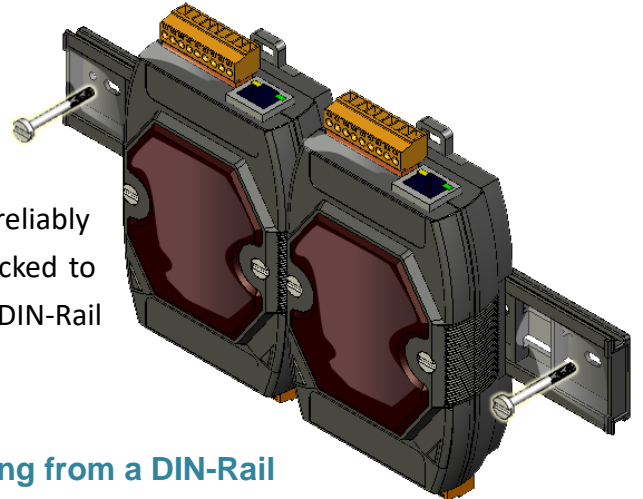

Mounting on a DIN-Rail

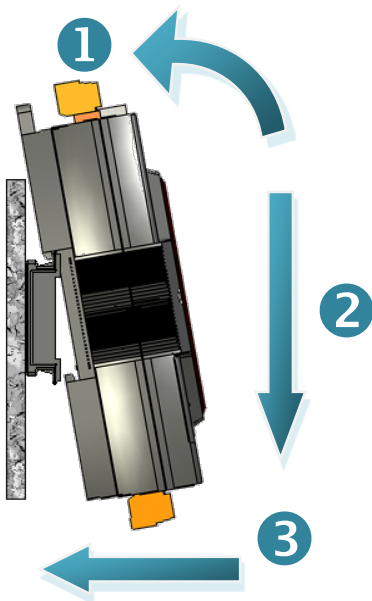

Dismounting from a DIN-Rail

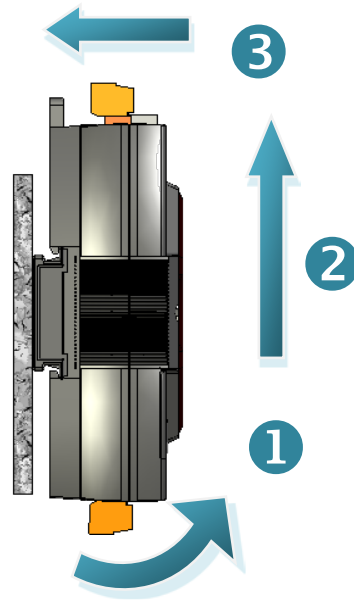

Mountable DIN-Rail Models

Din-Rail mounts are available in three sizes, and enable a variety of ICP DAS devices to be mounted. Each is made of stainless steel and has a ground wire attached at one end.

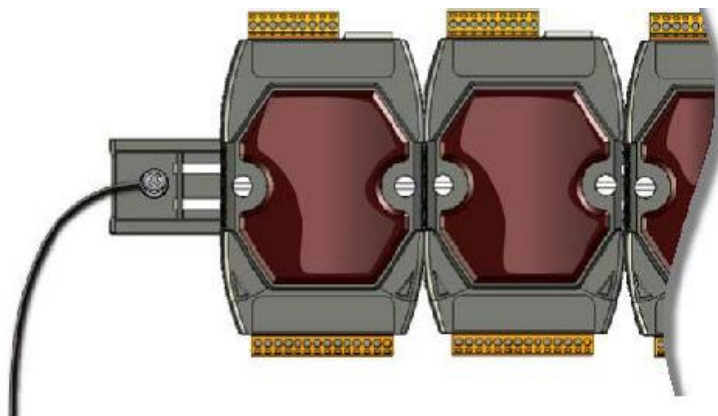

Part Number	Maximum Number of Modules	Dimensions
DRS-125	2	125 mm x 35 mm
DRS-240	3	240 mm x 35 mm
DRS-360	5	360 mm x 35 mm

Piggyback Mounting (for PETL-7060 only)

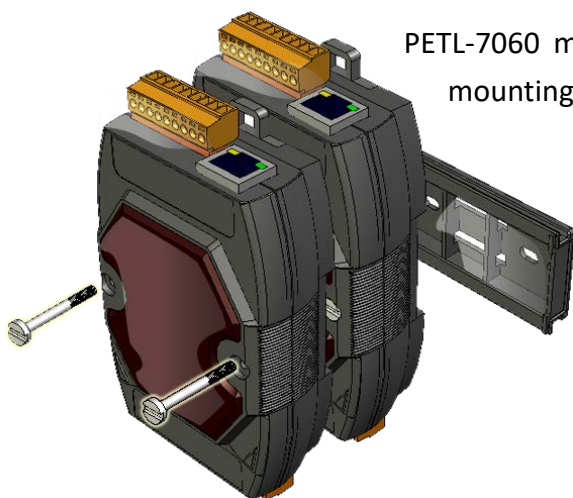

PETL-7060 module contains holes on each side to enable piggy back mounting.

3.2 Configuring the Boot Mode

All PETL/tET/tPET series modules have two operating modes that can be selected by using the switch mechanism incorporated on the chassis. Note that the module must be rebooted after changing the operating mode.

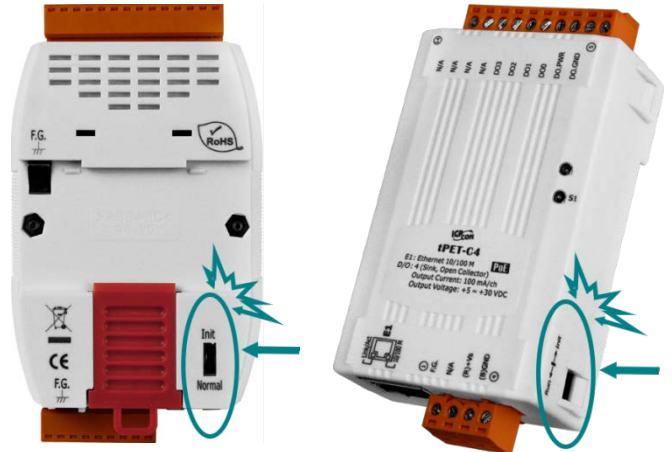

Init Mode

Init Mode should only be selected when updating the firmware or while troubleshooting. This mode forces the module to use the default factory settings.



Run/Normal Mode

Run/Normal Mode is the default operating mode and should be used in most cases.

 **Note**

Be sure to return the switch to the Run/Normal position once any firmware update is complete.

3.3 Connecting to a Network, a PC and a Power Supply

All PETL/tET/tPET series module are equipped with an RJ-45 Ethernet port to allow connection to an Ethernet hub/switch or a PC.

Uses Non-PoE Switch



Uses PoE Switch (for PETL/tPET only)

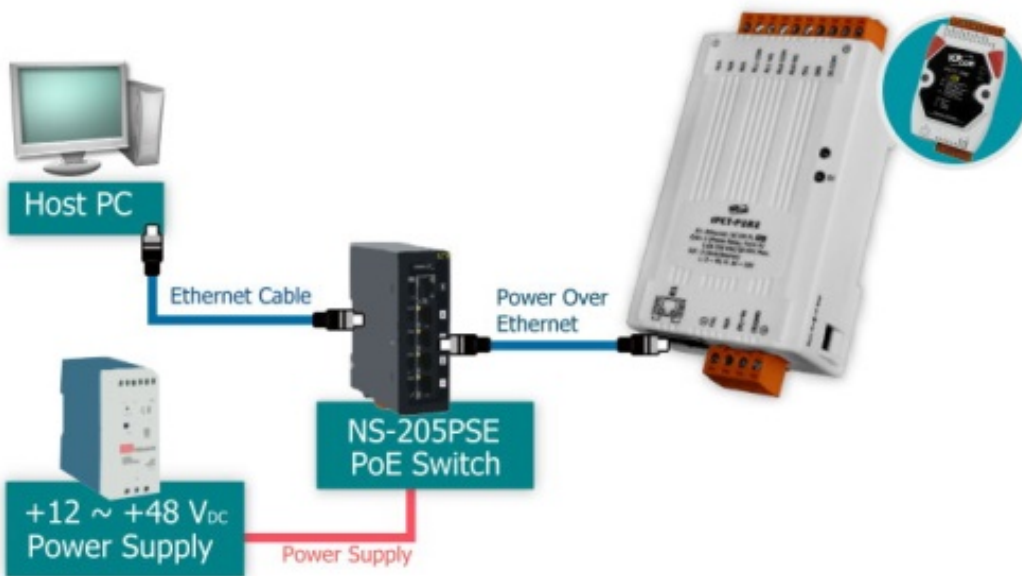

3.4 Using the eSearch Utility to Assign a New IP

The eSearch Utility is a useful tool that provides a quick and easy method of configuring the Ethernet settings for PETL/tET/tPET series module from a PC.

Step 1: Download and install the eSearch Utility software, and open the eSearch Utility

eSearch Utility can be obtained either from the companion CD at:

CD:\Napdos\Software\eSearch\

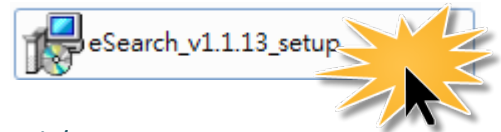

Or from the ICP DAS web site at:

<http://ftp.icpdas.com/pub/cd/tinymodules/napdos/software/esearch/>

Step 2: Click the “Search Servers” button to search for your module

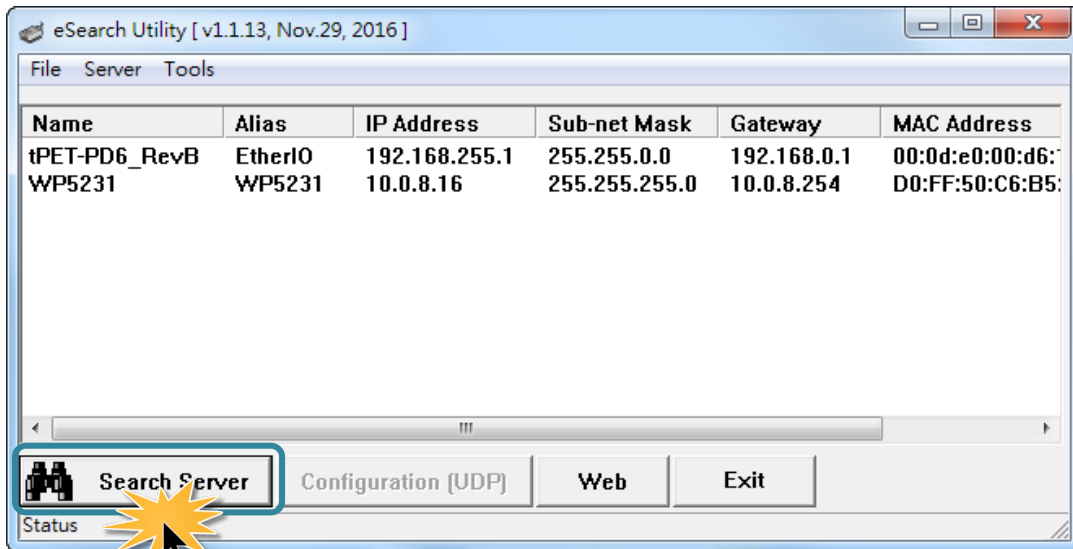

Step 3: Double-click the name of the module to open the server configuration dialog.

All PETL/tET/tPET series modules are IP-based devices that may not be suitable for your network using the default IP address. Therefore, you must first assign a new IP address to the PETL/tET/tPET series module depending on your network settings.

The factory default IP settings are:

IP Address: 192.168.255.1; Subnet Mask: 255.255.0.0; Gateway: 192.168.0.1.

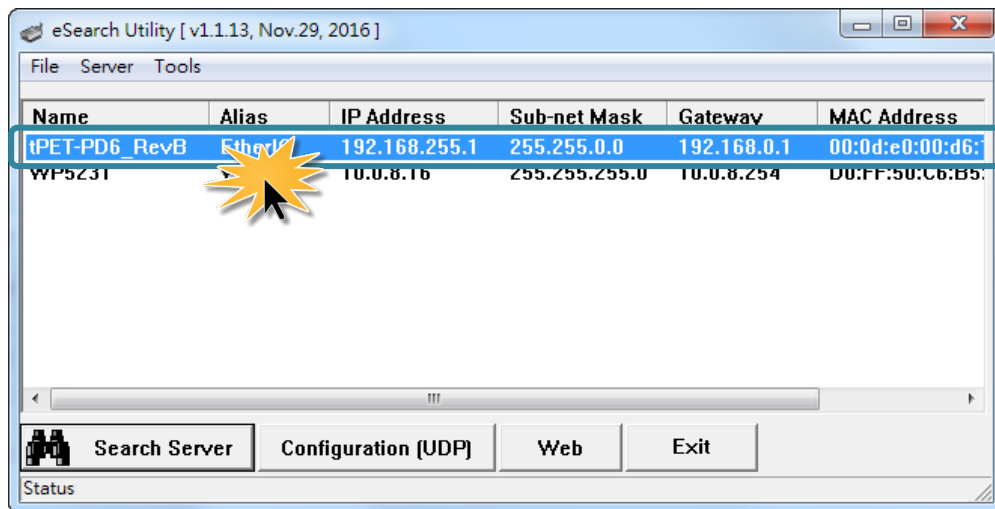

Step 4: Assign a new IP address and then click the “OK” button.

Contact your Network Administrator to obtain the correct network configuration information. Modify the network settings as necessary and then click the “OK” button. The PETL/tET/tPET series module will use the new settings immediately.

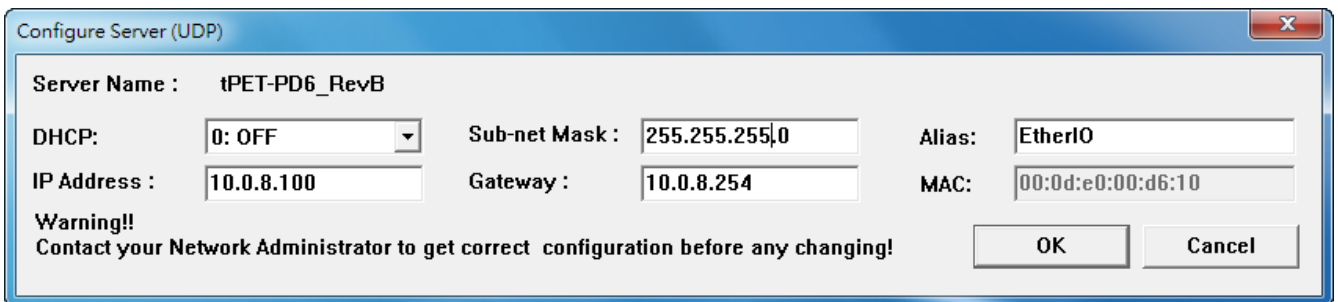

Step 5: Wait for 2 seconds and then click the “Search Servers” button again.

Ensure that the PETL/tET/tPET series module is operating correctly using the new configuration.

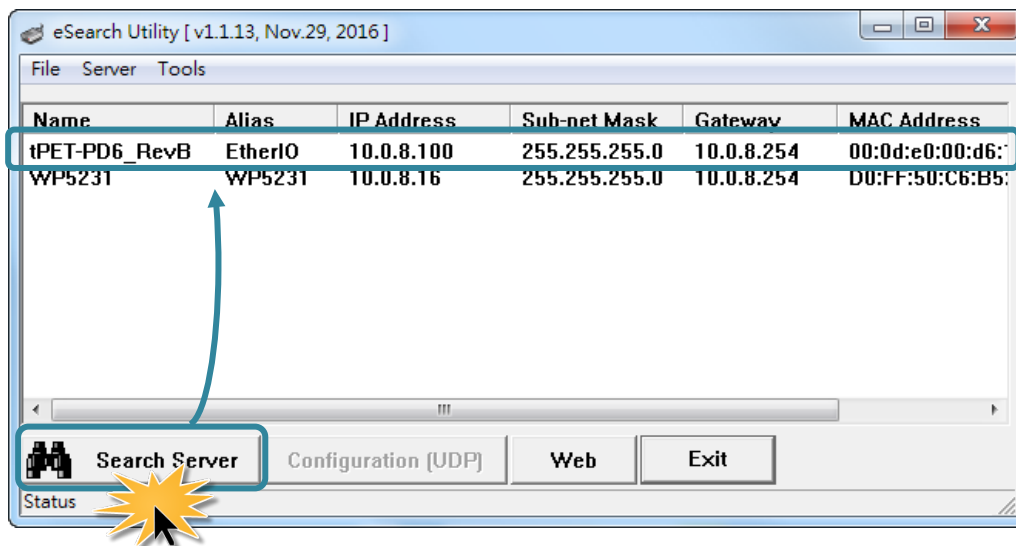

4. Web Configuration

All PETL/tET/tPET series module contain an advanced embedded web configuration system that provides I/O accessibility to the PETL/tET/tPET series module via a web browser.

4.1 Logging in to the Web Server

You can access the embedded PETL/tET/tPET series web server from any computer that has an Internet connection.

Step 1: Open a new browser window.

Open a standard web browser. For example, Mozilla Firefox, Google Chrome and Internet Explorer are reliable and popular internet browsers that can be used to configure PETL/tET/tPET series module.



Internet Explorer

Note that if you intend to use Internet Explorer, ensure that the cache to functions is disabled in order to avoid browser access errors. Detailed information how to do this can be found in [“FAQ 01: How to avoid a browser access error that causes a blank page to be displayed when using IE”](#).

Step 2: Enter the URL address of the PETL/tET/tPET web server.

Ensure that you have correctly configured the network settings for the PETL/tET/tPET series module, or refer to [Section 3.4 “Using the eSearch Utility to Assign a New IP”](#).

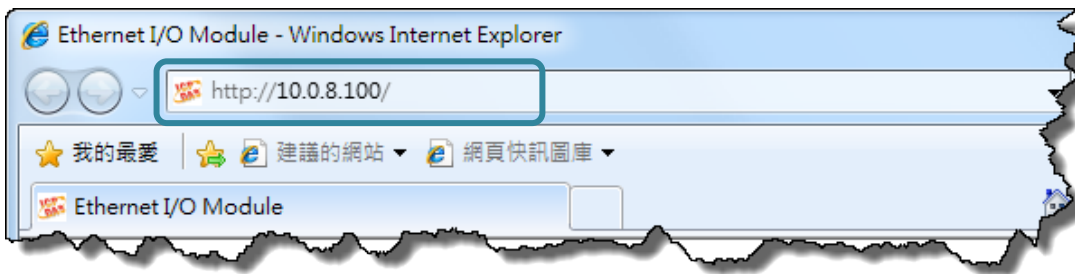

Step 3: Enter the password

After entering the IP address, the main login dialog page will be displayed prompting you to enter a password. The factory default password is “Admin”. Click the “Submit” button to continue.

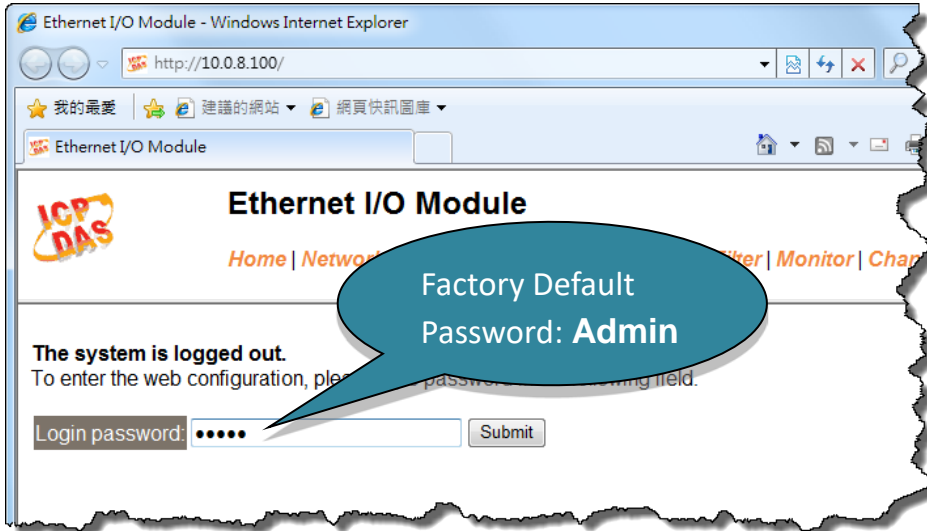

Step 4: Login to the PETL/tET/tPET web server

After logging into the PETL/tET/tPET web server, the main page will be displayed.

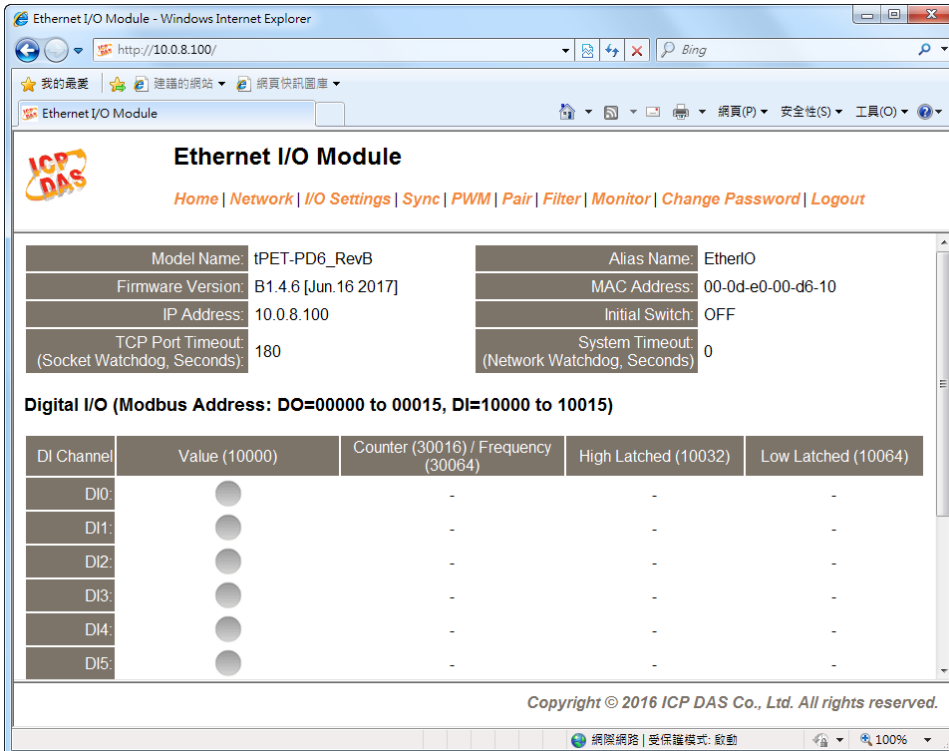

4.2 Home

The Home link connects to the main page, which contains three parts.



Ethernet I/O Module



The first part of this page provides basic information about the PETL/tET/tPET hardware and software.

Model Name:	tPET-P2POR2_RevB	Alias Name:	EtherIO
Firmware Version:	B1.4.6 [Jun.16 2017]	MAC Address:	00-0d-e0-02-02-02
IP Address:	10.0.8.35	Initial Switch:	OFF
TCP Port Timeout: (Socket Watchdog, Seconds):	180	System Timeout: (Network Watchdog, Seconds)	0

The software and hardware information section includes information related to the Model Name, the current Firmware version, the IP Address, the current position of the Initial Switch, the Alias, the MAC Address, and the TCP Port, and the System Timeout values. **If you update the firmware for the PETL/tET/tPET series module, this page can be used to check the version information of the PETL/tET/tPET software.**

The second section provides information related to the current status of pair-connection settings and Digital Output Control. *Note: User can click on the DO image to switch the output state.*

Digital I/O (Modbus Address: DO=00000 to 00015, DI=10000 to 10015)

	DO7	DO6	DO5	DO4	DO3	DO2	DO1	DO0
DI Channel	Value (10000)		Counter (30016) / Frequency (30064)		High Latched (10032)		Low Latched (10064)	
DI0:				0.00 Hz		-		-
DI1:				0.00 Hz		-		-
DI2:				-		-		-
DI3:				-		-		-
DI4:				-		-		-
DI5:				-		-		-
DI6:				-		-		-
DI7:				-		-		-

The third section provides details related the status of the I/O pair-connections.

Current port settings:

Pair-Connection Settings	Port 1
Server Mode:	Server
Remote Server IP:	Disabled
Remote TCP Port:	Disabled

4.3 Network Settings



Ethernet I/O Module

[Home](#) | [Network](#) | [I/O Settings](#) | [Sync](#) | [PWM](#) | [Pair](#) | [Filter](#) | [Monitor](#) | [Change Password](#) | [Logout](#)

Model Name:	tPET-P2POR2_RevB	Alias Name:	EtherIO
Firmware Version:	B1.4.6 [Jun.16 2017]	MAC Address:	00-0d-e0-02-02-02
IP Address:	10.0.8.35	Initial Switch:	OFF
TCP Port Timeout (Socket Watchdog, Seconds):	180	System Timeout (Network Watchdog, Seconds)	0

Clicking the **Network** tab will display the **IP Address Configuration** page allowing you verify the current settings and configure the IP Address parameters, configure the general parameters and restore the default settings for the PETL/tET/tPET series module, each of which will be described in more detail below.

IP Address Configuration

IP Address Configuration

IP Address	
Address Type	DHCP ▾
Static IP Address	255 . 255 . 255 . 255
Subnet Mask	0 . 0 . 0 . 0
Default Gateway	0 . 0 . 0 . 0
MAC Address	00-0d-e0-02-02-02 (Format: FF-FF-FF-FF-FF-FF)
Modbus TCP Slave	
Local Modbus TCP port	502 (Default= 502)
Local Modbus NetID	1 (Default= 1) <input type="checkbox"/> Enable ▾ (Default= Enable)
<input type="button" value="Update Settings"/>	

The following table provides an overview of the parameters contained in the **IP Address configuration** section:

Item	Description
Address Type	<p>Static IP: If there is no DHCP server installed in your network, you can configure the network settings manually. Refer to Section “Manual Configuration” for more details.</p>
	<p>DHCP: Dynamic Host Configuration Protocol (DHCP) is a network application protocol that automatically assigns an IP address to each device. Refer to Section “Dynamic Configuration” for more details.</p>
Static IP Address	<p>Each PETL/tET/tPET module connected to the network must have its own unique IP address. This parameter is used to assign a specific IP address.</p>
Subnet Mask	<p>This parameter is used to assign the subnet mask for the PETL/tET/tPET module. The subnet mask indicates which portion of the IP address is used to identify the local network or subnet.</p>
Default Gateway	<p>This parameter is used to assign the IP Address of the Gateway to be used by the PETL/tET/tPET module. A Gateway (or router) is a device that is used to connect an individual network to one or more additional networks.</p>
MAC Address	<p>This parameter is used to set the User-defined MAC address, which must be in the format FF-FF-FF-FF-FF-FF.</p>
Modbus TCP Slave	
Local Modbus TCP port	<p>This parameter is used to set the local port to be used by the Modbus slave device. The default value is 502.</p>
Local Modbus Net ID	<p>This parameter is used to set the Network ID to be used by the Modbus slave device. The default value is 1.</p>
Update Settings	<p>Click this button to save the revised settings to the PETL/tET/tPET module.</p>

Dynamic Configuration

Dynamic configuration is very easy to perform. If a DHCP server is connected to you network, a network address can be dynamically configured by using the following procedure:

Step 1: Select “DHCP” from the **Address Type** drop-down menu.

Step 2: Click the “Update Settings” button to complete the configuration.

IP Address	
Address Type	DHCP 1
Static IP Address	255 . 255 . 255 . 255
Subnet Mask	0 . 0 . 0 . 0
Default Gateway	0 . 0 . 0 . 0
MAC Address	00-0d-e0-02-02-02 (Format: FF-FF-FF-FF-FF-FF)
Modbus TCP Slave	
Local Modbus TCP port	502 (Default= 502)
Local Modbus NetID	1 (Default= 1) Enable ▼ (Default= Enable)
Update Settings 2	

Manual Configuration

When using manual configuration, the network settings should be assigned in the following manner:

Step 1: Select “Static IP” from the **Address Type** drop-down menu.

Step 2: Enter the relevant details in the respective **network settings** fields.

Step 3: Click the “Update Settings” button to complete the configuration.

IP Address	
Address Type	Static IP 1
Static IP Address	10 . 0 . 8 . 100
Subnet Mask	255 . 255 . 255 . 0 2
Default Gateway	10 . 0 . 8 . 254
MAC Address	00-0d-e0-02-02-02 (Format: FF-FF-FF-FF-FF-FF)
Modbus TCP Slave	
Local Modbus TCP port	502 (Default= 502)
Local Modbus NetID	1 (Default= 1) Enable ▼ (Default= Enable)
Update Settings 3	

General Settings

General Settings

Ethernet Speed	Auto ▾ (Auto=10/100 Mbps Auto-negotiation)
System Timeout (Network Watchdog)	0 (30 ~ 65535 s, Default= 0, Disable= 0) Action:Reboot
TCP Timeout	180 (5 ~ 65535 s, Default= 180, Disable= 0) Action:Cut-off
UDP Configuration	Enable ▾ (Enable/Disable the UDP Configuration, Enable=default.)
Web Auto-logout	10 (1 ~ 65535 minutes, Default= 10, Disable= 0)
HTTP port	80 (Default= 80)
Alias Name	EtherIO (Max. 18 chars)
<input type="button" value="Update Settings"/>	

The following table provides an overview of the parameters contained in the **General Settings** section:

Item	Description
Ethernet Speed	This parameter is used to set the Ethernet speed. The default value is Auto (Auto = 10/100 Mbps Auto-negotiation).
System Timeout (Network Watchdog)	This parameter is used to configure the system timeout value. If there is no activity on the network for a certain period of time, the system will be rebooted based on the configured system timeout value.
TCP Timeout (Seconds)	This parameter is used to configure the TCP timeout value. If Modbus TCP communication is idle for a certain period of time, the system will cut off the connection.
UDP Configuration	This parameter is used to enable or disable UDP configuration function.
Web Auto-logout	This parameter is used to configure the automatic logout value. If there is no activity on the web server for a certain period of time, the current user account will automatically logged out.
HTTP Port	This parameter is used to assign specific a HTTP port of PETL/tET/tPET module. The PETL/tET/tPET module needs to be restarted when the HTTP port is changed. You need manually type the new HTTP port in the address bar of the browser. The default is 80. For example: if the HTTP port is set to 81, then enter the "IP address:HTTP port" (10.0.8.123:81).
Alias Name	This parameter is used to assign an alias name for each PETL/tET/tPET module to assist with easy identification.
Update Settings	Click this button to save the revised settings to the PETL/tET/tPET module.

Restore Factory Defaults

Restore Factory Defaults

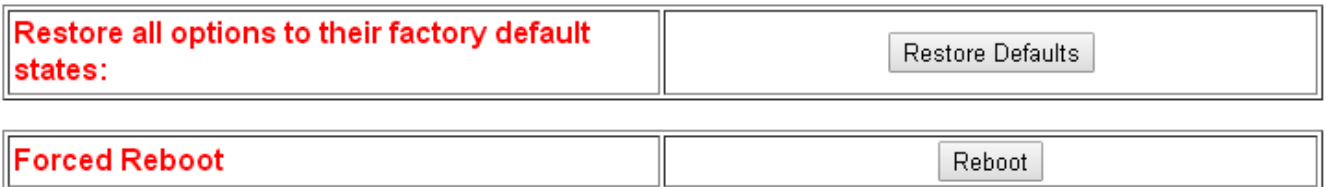

➤ **Restore all options to their factory default states**

To reset all parameters to their original factory default settings, use the following procedure:

Step 1: Click the “Restore Defaults” button to reset the configuration.

Step 2: Click the “OK” button in the message dialog box.

Step 3: Check whether the module has been reset to the original factory default settings for use with the eSearch Utility. Refer to [Section 3.4 Using the eSearch Utility to assign a new IP](#)”.

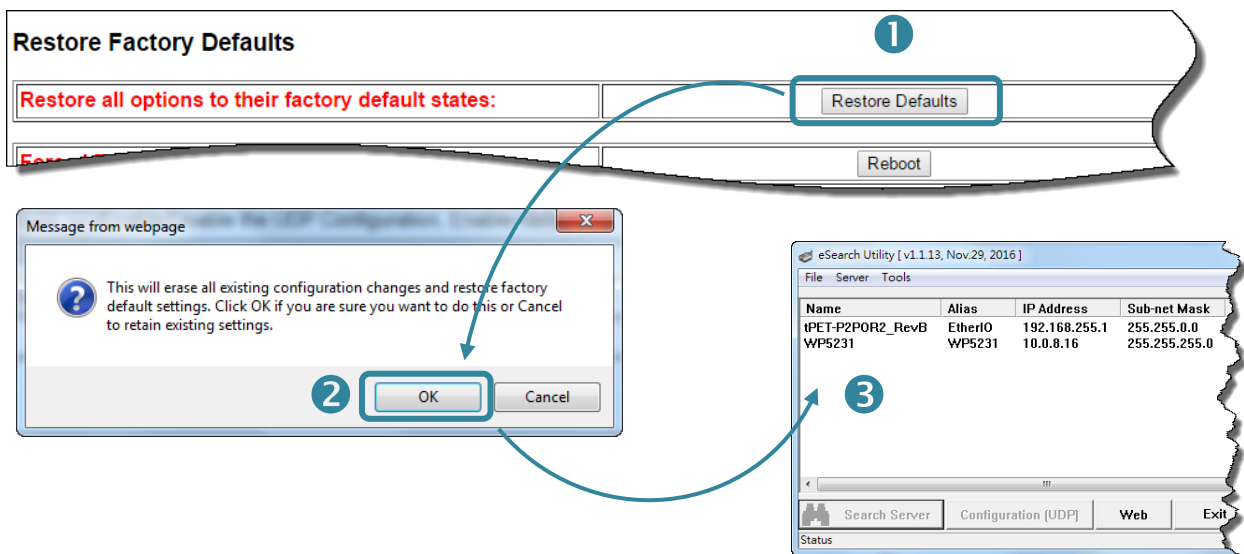

The following table provides an overview of the factory default settings:

Factory Default Settings

IP Address	192.168.255.1
Gateway Address	192.168.0.1
Subnet Mask	255.255.0.0

➤ **Forced Reboot**

The **Forced Reboot** function: can be used to force the PETL/tET/tPET module to reboot or to remotely reboot for the device. After the PETL/tET/tPET module has rebooted, the original login screen will be displayed requesting that you enter your Login Password before continuing.

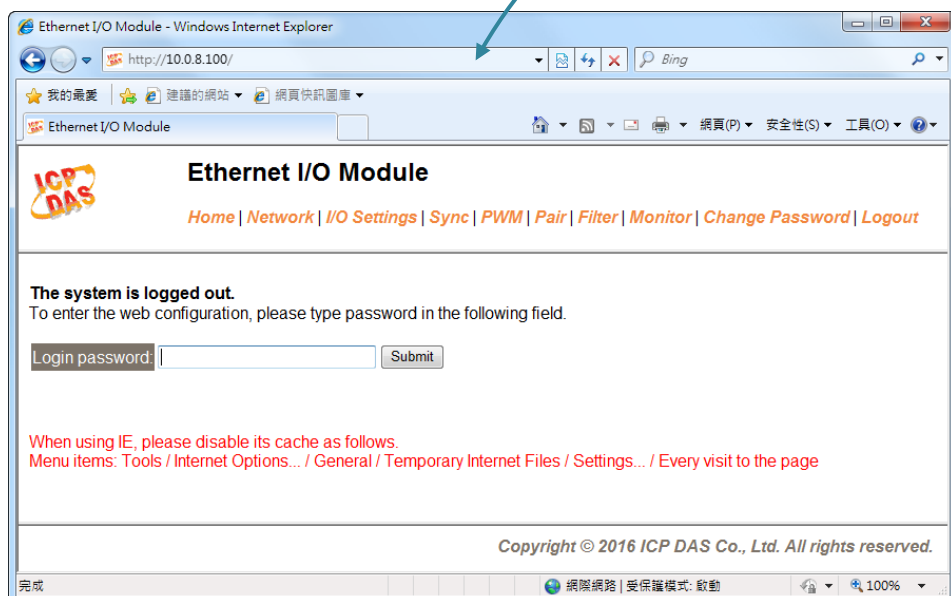
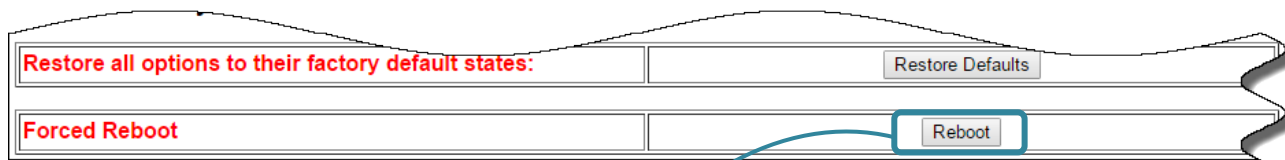

Firmware Update

Firmware Update

<p>If the remote firmware update is failed, then the traditional firmware update (on-site) is required to make the module working again.</p> <p>Step 1: Refer to firmware update manual first. Step 2: Run eSearch Utility to prepare and wait for update. Step 3: Click the [Update] button to reboot the module and start update. Step 4: Configure the module again.</p>	
---	---

Firmware update requires initialization and local network operations. Traditional firmware update requires adjusting the Init/Run Switch and reboots the module manually for the initialization of firmware update, while new firmware allows user to initialize the module via web interface without adjusting the hardware switch. Initialization via web is useful when module is installed in remote site and can be accessed by a remote PC via TeamViewer.

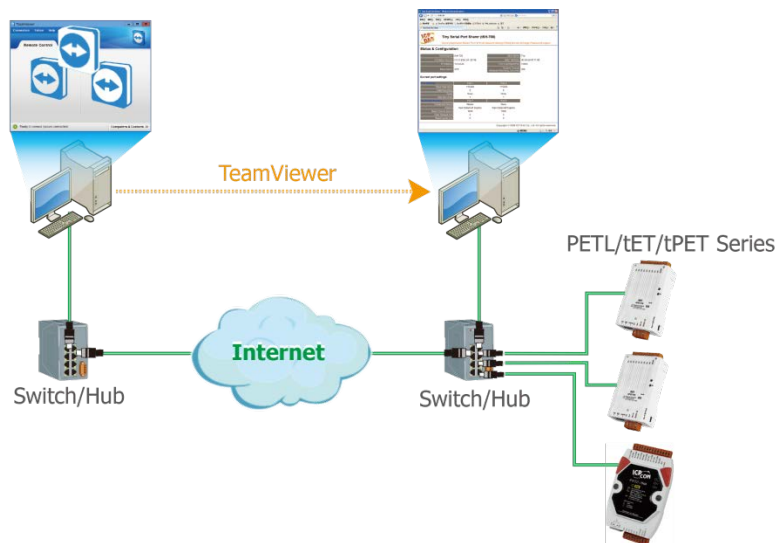

⚠ Note: If the remote firmware update is failed, then the traditional firmware update (Local) is required to make the module working again.

For detailed information about how to remote update the Firmware for the PETL/tET/tPET module, refer to the **tPET_PETL_Firmware_Update_vxxx_en.pdf**. The location of the user manual on the CD and the download address are shown below:



CD:\\ NAPDOS\\tPET\\Firmware\\



<http://ftp.icpdas.com/pub/cd/tinymodules/napdos/tpet/firmware/>

4.4 I/O Settings



Ethernet I/O Module

Home | Network | **I/O Settings** | Sync | PWM | Pair | Filter | Monitor | Change Password | Logout

Model Name:	tPET-P2POR2_RevB	Alias Name:	EtherIO
Firmware Version:	B1.4.6 [Jun.16 2017]	MAC Address:	00-0d-e0-02-02-02
IP Address:	10.0.8.35	Initial Switch:	OFF
TCP Port Timeout (Socket Watchdog, Seconds):	180	System Timeout (Network Watchdog, Seconds)	0

Clicking the **I/O Settings** tab will display the **DO Control and DI/DO Configuration** page allowing you configure the Digital Input and Digital Output parameters for the PETL/tET/tPET module. This page including Digital Output control, DI/DO Configuration, etc., each of which will be described in more detail below.

DO Control

DO Control

Digital Output	Modbus Address	Setting
Value	00007 - 00000	0xD Ch 7~4(<input type="checkbox"/> <input type="checkbox"/> <input type="checkbox"/> <input type="checkbox"/>) Ch 3~0(<input type="checkbox"/> <input type="checkbox"/> <input type="checkbox"/> <input type="checkbox"/>)
<input type="button" value="Update Settings"/>		

The following table provides an overview of the parameters contained in the **DO Control** section:

Item	Description
Set DO value	This parameter is used to manually assign a specific a value for the DO.
Update Settings	Click this button to save the revised settings to the PETL/tET/tPET module.

DI/DO Configuration

DI/DO Configuration:

Digital Output	Modbus Address	Setting
Host/Slave Watchdog Timeout	40257	0 (10 ~ 65535 Seconds, Default= 0, Disable= 0) Outputs DO with safe-value or PWM when host/slave timeout.
Enable Safe Value (Enable Watchdog)	00339 - 00332	0x0 Ch 7~4(<input type="checkbox"/> <input type="checkbox"/> <input type="checkbox"/> <input type="checkbox"/>) Ch 3~0(<input type="checkbox"/> <input type="checkbox"/> <input type="checkbox"/> <input type="checkbox"/>)
Safe Value	00274 - 00267	0x0 Ch 7~4(<input type="checkbox"/> <input type="checkbox"/> <input type="checkbox"/> <input type="checkbox"/>) Ch 3~0(<input type="checkbox"/> <input type="checkbox"/> <input type="checkbox"/> <input type="checkbox"/>)
Power-On Value	00242 - 00235	0x0 Ch 7~4(<input type="checkbox"/> <input type="checkbox"/> <input type="checkbox"/> <input type="checkbox"/>) Ch 3~0(<input type="checkbox"/> <input type="checkbox"/> <input type="checkbox"/> <input type="checkbox"/>)
Digital Input	Modbus Address	Setting
Enable Latched DI	00150	0 (Disable All= 0, Enable All= 1)
Clear Latched Status (High)	00032	0 (No Operation= 0, Clear All= 1)
Clear Latched Status (Low)	00033	0 (No Operation= 0, Clear All= 1)
DI Filter Level	-	0 (1 ~ 6500 ms, Default= 0, Disable= 0)
Digital Counter	Modbus Address	Setting
Enable Digital Counter	00158 - 00151	0x0 Ch 7~4(<input type="checkbox"/> <input type="checkbox"/> <input type="checkbox"/> <input type="checkbox"/>) Ch 3~0(<input type="checkbox"/> <input type="checkbox"/> <input type="checkbox"/> <input type="checkbox"/>)
Clear Digital Counter	00041 - 00034	0x0 Ch 7~4(<input type="checkbox"/> <input type="checkbox"/> <input type="checkbox"/> <input type="checkbox"/>) Ch 3~0(<input type="checkbox"/> <input type="checkbox"/> <input type="checkbox"/> <input type="checkbox"/>)
Preset Counter Value	40065 - 40050	Ch 07: 0 Ch 06: 0 Ch 05: 0 Ch 04: 0 Ch 03: 0 Ch 02: 0 Ch 01: 0 Ch 00: 0
Frequency Measurement (DI)	Modbus Address	Setting
Enable Frequency Measurement	00197 - 00190	0x0 Ch 7~4(<input type="checkbox"/> <input type="checkbox"/> <input type="checkbox"/> <input type="checkbox"/>) Ch 3~0(<input type="checkbox"/> <input type="checkbox"/> <input type="checkbox"/> <input type="checkbox"/>)
Scan Mode	40150	Single pulse ▾ 1000 ms: 1 Hz ~ 3 kHz (+/- 1 Hz error). 100 ms: 100 Hz to 3 kHz (+/- 10 Hz error). Single-pulse: 0.01 Hz ~ 1 Hz (+/- 0.01 Hz error), for stable signal only. Note: ET-2254P supports counter/frequency up-to 2.5 kHz.
Moving Average	40200	1 ▾
Universal DIO	Modbus Address	Setting
Force DI/DO Mode	00299 00307 - 00300	Dynamic ▾ Static: By configuration. Dynamic: Depends on DO requests. 0x300 Ch 7~4(<input type="checkbox"/> <input type="checkbox"/> <input type="checkbox"/> <input type="checkbox"/>) Ch 3~0(<input type="checkbox"/> <input type="checkbox"/> <input type="checkbox"/> <input type="checkbox"/>) (0=DO, 1=DI; for ET-2254 Only)

The following table provides an overview of the parameters contained in the **DI/DO Configuration** section:

Item	Description
Digital Output	
Host/Slave Watchdog Timeout	This parameter is used to configure the Host Watchdog timeout value. If there is no Modbus TCP communication activity for the specified period (the timeout), then the Host Watchdog will activate an alarm.
Enable Safe Value (Enable Watchdog)	This parameter is used to enable the watchdog on each DO channels.
Safe Value	This parameter is used to define the DO safe value for the PETL/tET/tPET module. If the Host Watchdog alarm is activated, the DO will be set to the user-defined safe value.
Power-On Value	This parameter is used to define the DO Power-on value. On boot up, the DO is set to the user-defined Power-on value.

Digital Input	
Enable Latched DI	This parameter is used to enable the latch function on all DI channels. The status of the DI will be recorded if it has been flagged as either high or low. 0 = Disable All; 1 = Enable All
Clear Latched Status (High)	This parameter is used to clear the status of all high latched D/I. 0 = No Operation; 1 = Clear All
Clear Latched Status (Low)	This parameter is used to clear the status of all low latched D/I. 0 = No Operation; 1 = Clear All
DI Filter Level	The DI filter is a function that eliminates high-frequency noise from inputs. Settings range value: 1 ~ 6500 (ms); 0 = Disable (Default). Refer to “FAQ004 What is Digital-Input Filter (DI Filter)” for more detailed information.
Digital Counter	
Enable Digital Counter	This parameter is used to enable the digital counter on each DI channels.
Clear Digital Counter	This parameter is used to clear the values of each DI counters.
Preset Counter Value	This parameter is used to set the default value for each DI counters.
Frequency Measurement by DI	
Enable Frequency Measurement	This parameter is used to enable the frequency measurement function on each DI channels.
Scan Mode	<p>This parameter is used to define the scan mode for the frequency measurement.</p> <p>1000 ms:This mode provides a normal update rate and normal accuracy. The acceptable frequency range for the input signal is 1 Hz to 3.5 kHz (± 1 Hz error). This mode can be used when the pulse width (signal source) contains small errors, since the measurement is based on the pulse count.</p> <p>100 ms:This mode provides fast update rate, but the accuracy is low. The acceptable frequency range for the input signal is 100 Hz to 3.5 kHz (± 10 Hz error). This mode can be used when the pulse width (signal source) contains small errors, since the measurement is based on the pulse count.</p> <p>Single-pulse:This mode provides the highest accuracy but can only be used for stable signal. The data update rate depends on the signal frequency and the acceptable signal frequency range for the input signal is 0.01 Hz to 3.5 kHz (± 0.01 Hz error). This mode can only be used when the pulse width (signal source) is stable, since the measurement is based on the width of a single pulse.</p>

<p>Moving Average</p>	<p>1 ==> No Average is used 2 ==> Uses the average of 2 continuous sample values 4 ==> Uses the average of 4 continuous sample values 8 ==> Uses the average of 8 continuous sample values</p>
<p>Universal DIO</p>	
<p>Force DI/DO Mode (For ET-2254 only)</p>	<p>Dynamic: Dynamic I/O types based on DO request. Static: Static I/O type by configuration (web or Modbus). <input type="text" value="0xf00"/> Ch 7~4(<input type="checkbox"/> <input type="checkbox"/> <input type="checkbox"/> <input type="checkbox"/>) Ch 3~0(<input type="checkbox"/> <input type="checkbox"/> <input type="checkbox"/> <input type="checkbox"/>) This parameter is used to set the Universal DIO channels to DI or DO Port. 1 ==> DI; 0 ==> DO</p>
<p>Update Settings</p>	<p>Click this button to save the revised settings of DI/DO configuration to the PETL/tET/tPET module.</p>

4.5 Sync



Ethernet I/O Module

[Home](#) | [Network](#) | [I/O Settings](#) | [Sync](#) | [PWM](#) | [Pair](#) | [Filter](#) | [Monitor](#) | [Change Password](#) | [Logout](#)

Model Name:	tPET-P2POR2_RevB	Alias Name:	EtherIO
Firmware Version:	B1.4.6 [Jun.16 2017]	MAC Address:	00-0d-e0-02-02-02
IP Address:	10.0.8.35	Initial Switch:	OFF
TCP Port Timeout (Socket Watchdog, Seconds):	180	System Timeout (Network Watchdog, Seconds):	0

Clicking the **Sync** tab will display the **DIO Synchronization** page allowing you configure the Synchronous DIO, Min-switching time of DO and Auto-off Time of DO for the PETL/tET/tPET series module, each of which will be described in more detail below.

DIO Synchronization

DIO Synchronization

Synchronous DIO (Local Mirror)	Modbus Address	Setting
Level Sync (DO=DI)	00403 - 00396	<input type="text" value="0x0"/> CH7-CH4: <input type="checkbox"/> <input type="checkbox"/> <input type="checkbox"/> <input type="checkbox"/> CH3-CH0: <input type="checkbox"/> <input type="checkbox"/> <input type="checkbox"/> <input type="checkbox"/> Set the DO state to the same as the DI state.
Rising Active (DO=ON)	00419 - 00412	<input type="text" value="0x0"/> CH7-CH4: <input type="checkbox"/> <input type="checkbox"/> <input type="checkbox"/> <input type="checkbox"/> CH3-CH0: <input type="checkbox"/> <input type="checkbox"/> <input type="checkbox"/> <input type="checkbox"/> Turn ON DO when DI is changed from OFF to ON.
Falling Active (DO=ON)	00435 - 00428	<input type="text" value="0x0"/> CH7-CH4: <input type="checkbox"/> <input type="checkbox"/> <input type="checkbox"/> <input type="checkbox"/> CH3-CH0: <input type="checkbox"/> <input type="checkbox"/> <input type="checkbox"/> <input type="checkbox"/> Turn ON DO when DI is changed from ON to OFF.
Additional Controls	Modbus Address	Setting
Min-Switching Time of DO (0 to 65535 Seconds)	40283 - 40268	DO 15: <input type="text" value="0"/> DO 14: <input type="text" value="0"/> DO 13: <input type="text" value="0"/> DO 12: <input type="text" value="0"/> DO 11: <input type="text" value="0"/> DO 10: <input type="text" value="0"/> DO 09: <input type="text" value="0"/> DO 08: <input type="text" value="0"/> DO 07: <input type="text" value="0"/> DO 06: <input type="text" value="0"/> DO 05: <input type="text" value="0"/> DO 04: <input type="text" value="0"/> DO 03: <input type="text" value="0"/> DO 02: <input type="text" value="0"/> DO 01: <input type="text" value="0"/> DO 00: <input type="text" value="0"/>
		DO 15: <input type="text" value="0"/> DO 14: <input type="text" value="0"/> DO 13: <input type="text" value="0"/> DO 12: <input type="text" value="0"/> DO 11: <input type="text" value="0"/> DO 10: <input type="text" value="0"/> DO 09: <input type="text" value="0"/> DO 08: <input type="text" value="0"/> DO 07: <input type="text" value="0"/> DO 06: <input type="text" value="0"/> DO 05: <input type="text" value="0"/> DO 04: <input type="text" value="0"/> DO 03: <input type="text" value="0"/> DO 02: <input type="text" value="0"/> DO 01: <input type="text" value="0"/> DO 00: <input type="text" value="0"/>
Auto-off Time of DO (0 to 65535 Seconds)	40299 - 40284	DO 15: <input type="text" value="0"/> DO 14: <input type="text" value="0"/> DO 13: <input type="text" value="0"/> DO 12: <input type="text" value="0"/> DO 11: <input type="text" value="0"/> DO 10: <input type="text" value="0"/> DO 09: <input type="text" value="0"/> DO 08: <input type="text" value="0"/> DO 07: <input type="text" value="0"/> DO 06: <input type="text" value="0"/> DO 05: <input type="text" value="0"/> DO 04: <input type="text" value="0"/> DO 03: <input type="text" value="0"/> DO 02: <input type="text" value="0"/> DO 01: <input type="text" value="0"/> DO 00: <input type="text" value="0"/>
<input type="button" value="Update Settings"/>		

The following table provides an overview of the parameters contained in the **DIO Synchronization** section:

Item	Description
Synchronous DIO (Local Mirror)	
Level Sync (DO = DI)	This parameter is used to enable the synchronization operation in Digital Input/Output function.
Rising Active (DO = ON)	This parameter is used to enable rising active in Digital Input function. When the specified DI state changed from OFF to ON, the corresponding DO will be set to ON.
Falling Active (DO = ON)	This parameter is used to enable falling active in Digital Input function. When the specified DI state changed from ON to OFF, the corresponding DO will be set to ON.
Additional Controls	
Min-Switch Time of DO (0 to 65535 Seconds)	This parameter is used to set the minimum switching time between the ON and OFF state of the Digital Output. This protects some machines from being damaged by too many ON/OFF switches in a short time.
Auto-off Time of DO (0 to 65535 Seconds)	This parameter is used to set the auto-off time of the Digital Output. If the Digital Output is ON, the Digital Output will be auto-off based on the configured time value.
Update Settings	Click this button to save the revised settings of DIO configuration to the PETL/tET/tPET module.

4.6 PWM



Ethernet I/O Module

Home | Network | I/O Settings | Sync | **PWM** | Pair | Filter | Monitor | Change Password | Logout

Model Name:	tPET-P2POR2_RevB	Alias Name:	EtherIO
Firmware Version:	B1.4.6 [Jun.16 2017]	MAC Address:	00-0d-e0-02-02-02
IP Address:	10.0.8.35	Initial Switch:	OFF
TCP Port Timeout (Socket Watchdog, Seconds):	180	System Timeout (Network Watchdog, Seconds)	0

Clicking the **PWM** tab will display the **PWM Configuration** page allowing you enable and configure the PWM parameters for the PETL/tET/tPET device, including the PWM Alarm and duty cycle, etc., each of which will be described in more detail below.

PWM Configuration

PWM Configuration:

PWM Functions	Modbus Address	Setting
Enable PWM	00107 - 00100	0x0 Ch 7~4(<input type="checkbox"/> <input type="checkbox"/> <input type="checkbox"/> <input type="checkbox"/>) Ch 3~0(<input type="checkbox"/> <input type="checkbox"/> <input type="checkbox"/> <input type="checkbox"/>)
Enable PWM Alarm	00371 - 00364	0x0 Ch 7~4(<input type="checkbox"/> <input type="checkbox"/> <input type="checkbox"/> <input type="checkbox"/>) Ch 3~0(<input type="checkbox"/> <input type="checkbox"/> <input type="checkbox"/> <input type="checkbox"/>) (Activates the PWM outputs when Host/Slave Watchdog Timeout)
Duty Cycle	40115 - 40100	DO 07: (<input type="text" value="0"/> , <input type="text" value="0"/>) DO 06: (<input type="text" value="0"/> , <input type="text" value="0"/>) DO 05: (<input type="text" value="0"/> , <input type="text" value="0"/>) DO 04: (<input type="text" value="0"/> , <input type="text" value="0"/>) DO 03: (<input type="text" value="0"/> , <input type="text" value="0"/>) DO 02: (<input type="text" value="0"/> , <input type="text" value="0"/>) DO 01: (<input type="text" value="1000"/> , <input type="text" value="1000"/>) DO 00: (<input type="text" value="1000"/> , <input type="text" value="1000"/>) (High, Low: 10 ~ 65535 ms, 0= Disable)
<input type="button" value="Update Settings"/>		

The following table provides an overview of the parameters contained in the PWM Configuration section:

Item	Description	Default Value
Enable PWM	This parameter is used to enable the PWM output function.	0
Enable PWM Alarm	This parameter is used to enable the PWM output alarm function.	0

Item	Description	Default Value
Duty Cycle	<p>This parameter is used to set the duty cycle for the DO channels. Two values are required for each DO channel.</p> <p>The first value is the high pulse width, while the second is the low pulse width. The duty cycle is in 1 ms units, and the resolution is approximately 5 ms. (5 to 65535 ms). A value of 0 will disable the duty cycle functions for that channel.</p> <p>Refer to “FAQ: Can tET/tPET Modules achieve a PWM Output Accuracy of less than 1 ms” for more detailed information.</p>	1000 (ms)
Update Settings	Click this button to save the revised settings to the PETL/tET/tPET module.	

 **Note**

Because of the characteristics of the relay functions, it is recommended that the PWM on t(P)ET-P(D)2POR2/t(P)ET-P2R2/t(P)ET-PD2R1/PETL-7060 series module (i.e., modules with relay functions) is not used for extended periods of time.

4.7 Pair



Ethernet I/O Module

Home | Network | I/O Settings | Sync | PWM | **Pair** | Filter | Monitor | Change Password | Logout

Model Name:	tPET-P2POR2_RevB	Alias Name:	EtherIO
Firmware Version:	B1.4.6 [Jun.16 2017]	MAC Address:	00-0d-e0-02-02-02
IP Address:	10.0.8.35	Initial Switch:	OFF
TCP Port Timeout (Socket Watchdog, Seconds):	180	System Timeout (Network Watchdog, Seconds)	0

Clicking the **Pair** tab will display the **pair-connection Settings** page allowing you enable and configure the DI-to-DO pair connections for the PETL/tET/tPET module, which will be described in more detail below.

Pair-Connection Settings

The I/O pair connection function is a specific feature of the PETL/tET/tPET series modules that can be used to enable a pair of DI-to-DO connections via the Modbus TCP (Ethernet) protocol.

Pair-Connection Settings:

POLL Mode: (Remote DI -> Local DO)

PUSH Mode: (Local DI -> Remote DO)

Function in "BLUE" text available in "PUSH" Mode Only

| 1~5 | 6~10 | 11~12 |

#	Mode	Remote IP	Remote Port	Net ID	Scan Time	DI Count	DI Addr	DO Addr	TCP/UDP	Update
01	Disable ▾	0 . 0 . 0 . 0	502	1	1000 ms	0	0	0	TCP ▾	Submit
02	Disable ▾	0 . 0 . 0 . 0	502	1	1000 ms	0	0	0	TCP ▾	Submit
03	Disable ▾	0 . 0 . 0 . 0	502	1	1000 ms	0	0	0	TCP ▾	Submit
04	Disable ▾	0 . 0 . 0 . 0	502	1	1000 ms	0	0	0	TCP ▾	Submit
05	Disable ▾	0 . 0 . 0 . 0	502	1	1000 ms	0	0	0	TCP ▾	Submit

The following table provides an overview of the parameters contained in the *Pair-Connection Settings* section:

Item	Description	Default Value
Mode	<p>This parameter is used to define the Server mode for the PETL/tET/tPET series module.</p> <p>Mode = Disable: Server mode (Slave).</p> <p>Mode = POLL: Poll remote DI to local DO in the Client mode (Master).</p> <p>Mode = PUSH: Push local DI to remote DO in the Client mode (Master).</p> <p>The DI Count field must also be configured to enable Client mode.</p>	Disable
Remote IP	The IP address of the remote device to access.	0
Remote Port	The TCP port number of the remote device to access. Range: 0 to 65535.	502
Net ID	The Modbus Net ID of the remote device to access. Range: 1 to 247.	1
Scan Time	<p>For “POLL” mode, the module will update the DI/DO states based on the time period of the Scan Time parameter.</p> <p>For “PUSH” mode, the module will update remote DO state when the local DI state is changed. The module will also force update remote DO when the local DI is no change during the time period of the Scan Time parameter.</p> <p>Range: 1000 to 42949672965 ms.</p>	1000 ms
DI Count	<p>This parameter specifies how many digital I/O channels are mapped.</p> <p>Range: 1 to 16; 0= Disable.</p>	0
DI Addr	<p>For “POLL” mode, this parameter specifies the base address of the Remote DI device that will be mapped to the Local DO register. The range depends on the type of remote device being used.</p> <p>For “PUSH” mode, this parameter specifies the base address of the Local DI register that will be mapped to the Remote DO device. The range depends on the type of PETL/tET/tPET module being used.</p>	0

DO Addr	<p>For “POLL” mode, this parameter specifies the base address of the Local DO register that will be mapped to the Remote DI device. The range depends on the type of the ET-2200 module being used.</p> <p>For “PUSH” mode, this parameter specifies the base address of the Remote DO device that will be mapped to the Local DI register. The range depends on the type of remote device being used.</p>	0
TCP/UDP	<p>This parameter is used to set the type of Modbus protocol to be used and can be either TCP or UDP for the “PUSH” mode only.</p>	TCP
Submit	<p>Click this button to save the revised settings to PETL/tET/tPET module.</p>	

4.8 Filter



Ethernet I/O Module

[Home](#) | [Network](#) | [I/O Settings](#) | [Sync](#) | [PWM](#) | [Par](#) | **[Filter](#)** | [Monitor](#) | [Change Password](#) | [Logout](#)

Model Name:	tPET-P2POR2_RevB	Alias Name:	EtherIO
Firmware Version:	B1.4.6 [Jun.16 2017]	MAC Address:	00-0d-e0-02-02-02
IP Address:	10.0.8.35	Initial Switch:	OFF
TCP Port Timeout (Socket Watchdog, Seconds):	180	System Timeout (Network Watchdog, Seconds)	0

Clicking the **Filter** tab will display the **Filter Settings** page allowing you configure the IP Filter list for the PETL/tET/tPET module, which will be described in more detail below.

Filter Settings

The **Filter Settings** page is used to query or edit the IP Filter List for the PETL/tET/tPET series module. The IP filter list restricts the access of incoming packets based on the IP header. If one or more IP addresses are saved to the IP Filter table, only Clients whose IP address is specified in the IP Filter List will be able to access the PETL/tET/tPET series module.

Filter Settings:

Available IP List	IP Address
IP1:	0.0.0.0
IP2:	0.0.0.0
IP3:	0.0.0.0
IP4:	0.0.0.0
IP5:	0.0.0.0

Add . . . To The List
 Delete IP#
 Delete ALL
 Save to Flash

The following table provides an overview of the parameters contained in the IP Address Configuration section:

Item	Description
Add "IP" to the List	This parameter is used to add an IP address to the Available IP List.
Delete IP # "number"	This parameter is used to delete IP# address from the Available IP List.
Delete All	This parameter is used to delete all IP address current contained in the Available IP List.
Save to Flash	This parameter is used to save the updated Available IP List to the Flash memory. Check the checkbox before clicking the Submit button of you wish to store the most recent list.
Submit	Click this button to save the revised settings to PETL/tET/tPET module.

4.9 Monitor

After clicking the **Monitor** tab, the Current Connection Status page will be displayed showing detailed information regarding the current status of the serial port connection settings for the PETL/tET/tPET series module.



Ethernet I/O Module

[Home](#) | [Network](#) | [I/O Settings](#) | [Sync](#) | [PWM](#) | [Pair](#) | [Filter](#) | **Monitor** | [Change Password](#) | [Logout](#)



Current Connection Status:

Server Mode	Server
Connected IP1:	0.0.0.0
IP2:	0.0.0.0
IP3:	0.0.0.0
IP4:	0.0.0.0
IP5:	0.0.0.0
IP6:	0.0.0.0
Available Connections:	32

4.10 Change Password

Clicking the **Change Password** tab will display the **Change Password** page. To change a password, first enter the old password in the “**Current password**” field (default is **Admin**) and then enter a new password in the “**New password**” field. Re-enter the new password in the “**Confirm new password**” field, and then click the “**Submit**” button to update the password.



Ethernet I/O Module

[Home](#) | [Network](#) | [I/O Settings](#) | [Sync](#) | [PWM](#) | [Pair](#) | [Filter](#) | [Monitor](#) | **Change Password** | [Logout](#)



Change Password

The length of the password is 12 characters maximum.

Current password:	<input type="password" value="...."/>
New password:	<input type="password" value="...."/>
Confirm new password:	<input type="password" value="...."/>

4.11 Logout

Clicking the **Logout** tab will immediately log you out from the system and return you to the login page.



Ethernet I/O Module

[Home](#) | [Network](#) | [I/O Settings](#) | [Sync](#) | [PWM](#) | [Pair](#) | [Filter](#) | [Monitor](#) | [Change Password](#) | **Logout**



The system is logged out.

To enter the web configuration, please type password in the following field.

Login password:

When using IE, please disable its cache as follows.

Menu items: Tools / Internet Options... / General / Temporary Internet Files / Settings... / Every visit to the page

5. I/O Pair Connection Applications

The PETL/tET/tPET series modules can be used to create DI-to-DO pair connections via the Ethernet. Once the configuration is complete, the modules can then poll the status of the local DI channels and then use the Modbus/TCP protocol to continuously write to a remote DO device in the background. This is useful when connecting digital I/O devices that do not themselves have Ethernet capability. The following will describe how to correctly configure the I/O pair connection function.

5.1 One Module Polling the Remote DI/DO (1-to-1, Polling Mode)

Step 1: Connect the device to a Network, a PC and a Power supply.

Confirm that the PETL/tET/tPET series modules are functioning correctly. Refer to [Chapter 3. "Getting Started"](#) for more details. An example configuration shown below:

Note that tPET-P2POR2 and tPET-PD2POR2 modules are used in this example.

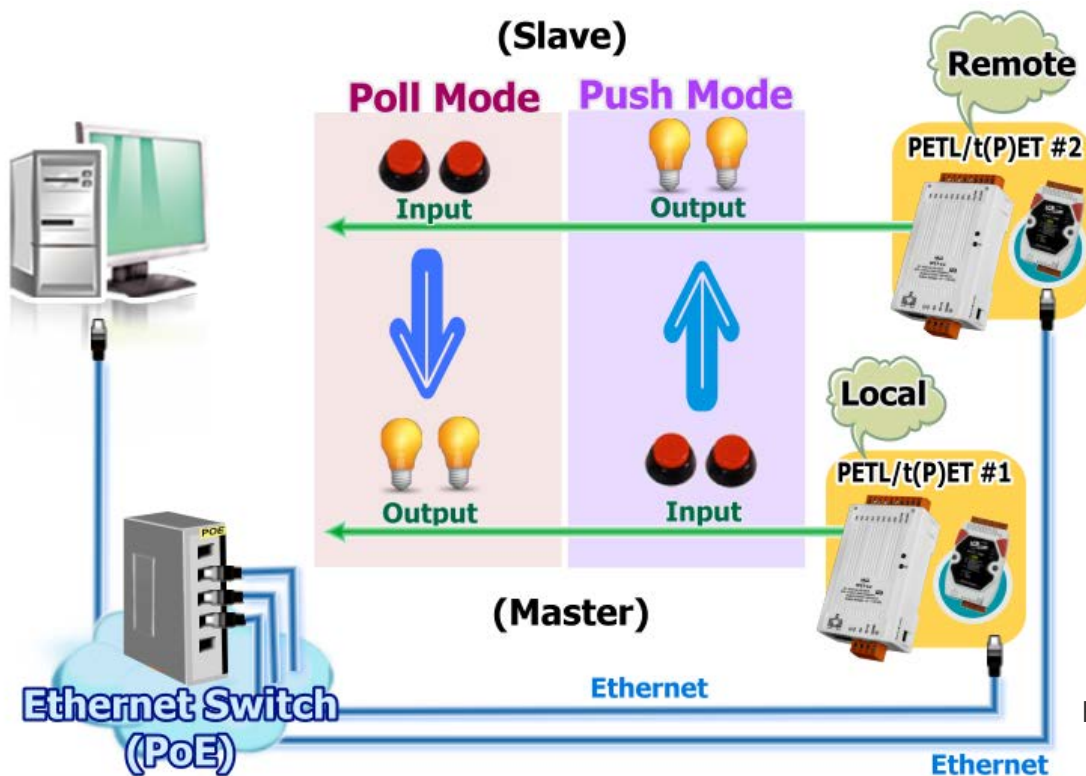

Figure 5-1.1

Step 2: Configure the Ethernet Settings

Contact your Network Administrator to obtain the correct network configuration information for the PETL/tET/tPET series modules, such as the IP Address, Subnet Mask, and Gateway details. Refer to [Section 3.4 “Using the eSearch Utility to assign a new IP”](#) for more details.

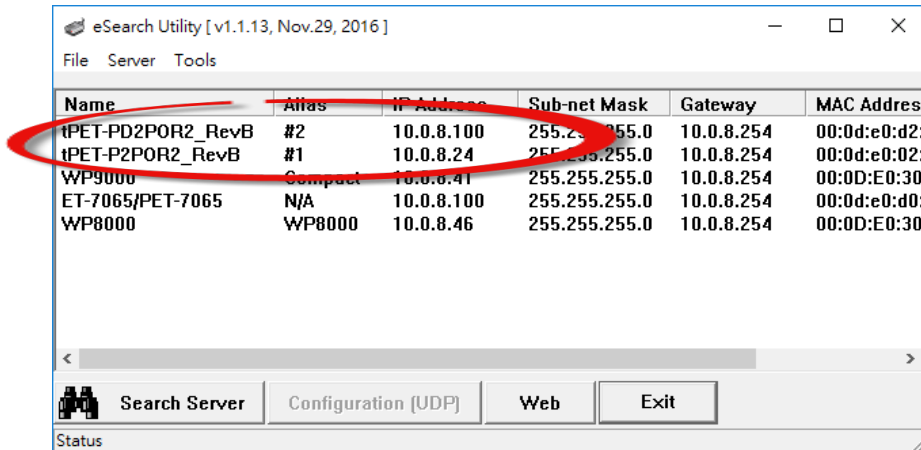

Figure 5-1.2

Step 3: Configure the I/O Pair connection on the Web Server

1. In the eSearch Utility, select **PETL/tET/tPET module #1** and then click the **“Web”** button to launch the browser program and connect to the web server.
2. Enter the password in the Login password field (**the default password is “Admin”**), and then click the **“Submit”** button to display the configuration page.

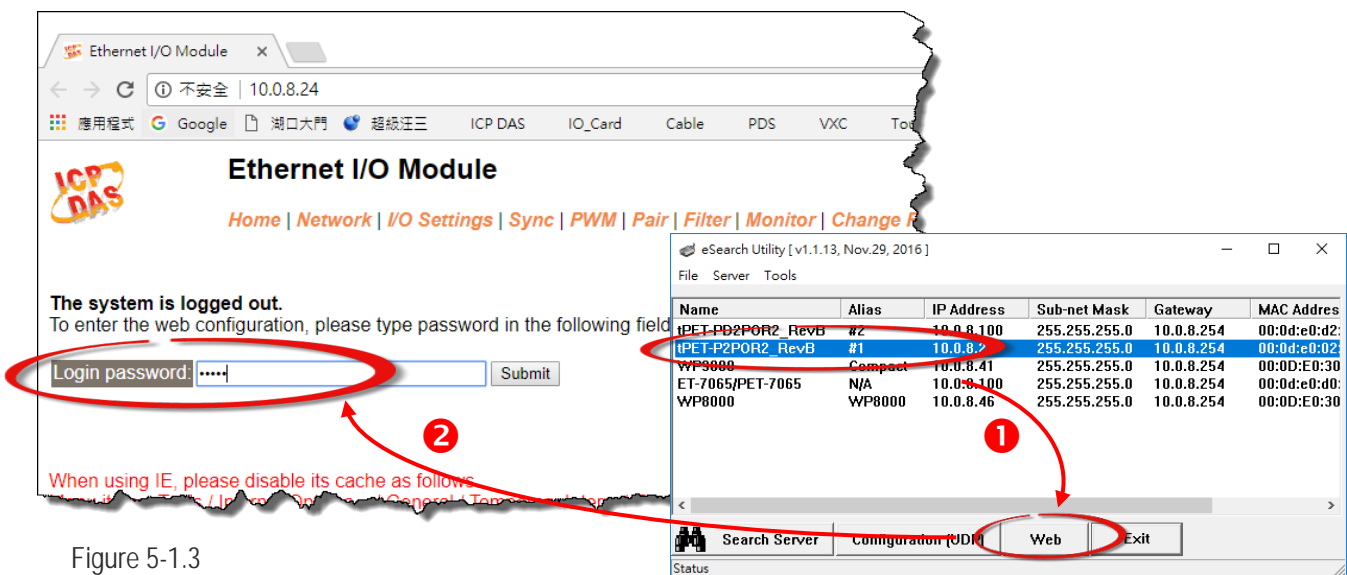

Figure 5-1.3

3. Click the “Pair” tab to display the Pair Connection settings page.

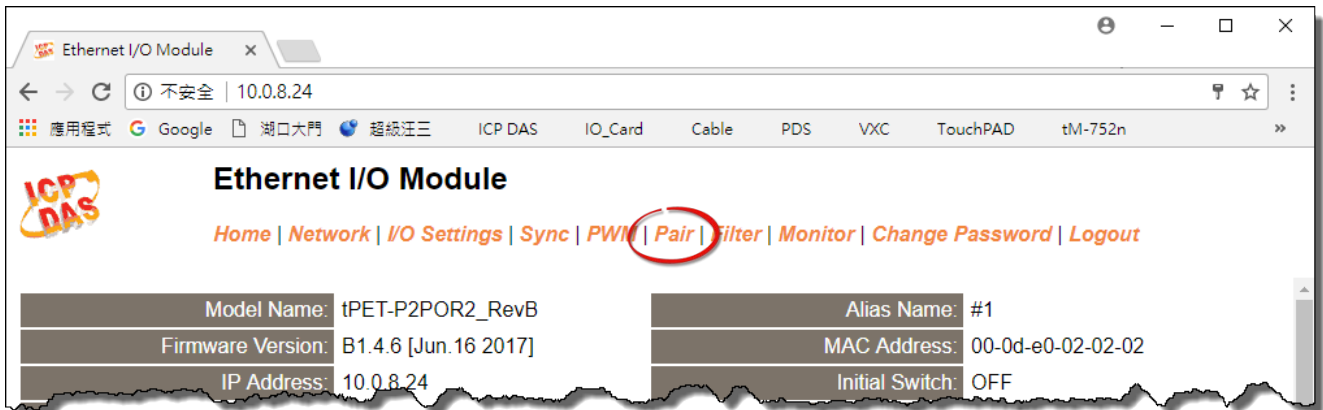

Figure 5-1.4

Polling Mode

4. In the “I/O Pair-connection Settings”, select “POLL” from the “**Mode**” drop-down options.
5. Enter the **IP address for tPET-PD2POR2 #2 module** in the “**Remote IP**” field.
6. Enter the **TCP Port for tPET-PD2POR2 #2 module** in the “**Remote Port**” field.
7. Enter a **DI Count Value for tPET-PD2POR2 #2 module** in the “**DI Count**” field (Remote DI to Local DO).

The following is an example of a **Polling mode** configuration:
 Enter “2” in the “**DI Count**” field. This means **DI x2 of tPET-PD2POR2 #2 module** is mapped to **DO x2 of tPET-P2POR2 #1 module**.

8. Click the “**Submit**” button to complete the configuration.

POLL Mode: (Remote DI -> Local DO)

PUSH Mode: (Local DI -> Remote DO)

Function in "BLUE" text available in "PUSH" Mode Only

| 1~5 | 6~10 | 11~12 |

#	Mode	Remote IP				Remote Port	Net ID	Scan Time	DI Count	DI Addr	DO Addr	TCP/UDP	Update
01	POLL	10	0	8	100	502	1	1000 ms	2	0	0	TCP	Submit
02	Disable	0	0	0	0	502	1	1000 ms	0	0	0	TCP	Submit
03	Disable	0	0	0	0	502	1	1000 ms	0	0	0	TCP	Submit
04	Disable	0	0	0	0	502	1	1000 ms	0	0	0	TCP	Submit
05	Disable	0	0	0	0	502	1	1000 ms	0	0	0	TCP	Submit

Figure 5-1.5

Push Mode

4. In the “I/O Pair-connection Settings”, select “**PUSH**” from the “**Mode**” drop-down options.
5. Enter the **IP address for tPET-PD2POR2 #2 module** in the “**Remote IP**” field.
6. Enter the **TCP Port for tPET-PD2POR2 #2 module** in the “**Remote Port**” field.
7. Enter a **DI Count Value for tPET-P2POR2 #1 module** in the “**DI Count**” field (Local DI to Remote DO).

The following is an example of a **Push mode** configuration:
 Enter “**2**” in the “**DI Count**” field. This means **DI x2 of tPET-P2POR2 #1 module** is mapped to **DO x2 of tPET-PD2POR2 #2 module**.

8. Select **Modbus protocol (e.g., “TCP”)** from the “**TCP/UDP**” drop-down options.
9. Click the “**Submit**” button to complete the configuration.

POLL Mode: (Remote DI -> Local DO)

PUSH Mode: (Local DI -> Remote DO)

Function in "BLUE" text available in "PUSH" Mode Only

| 1~5 | 6~10 | 11~12 |

#	Mode	Remote IP				Remote Port	Net ID	Scan Time			DI Count	DI Addr	DO Addr	TCP/UDP	Update
01	POLL	10	0	8	100	502	1	1000	ms	2	0	0	TCP	Submit	
02	PUSH	10	0	8	100	502	1	1000	ms	2	0	0	TCP	Submit	
03	Disable	0	0	0	0	502	1	1000	ms	0	0	0	TCP	Submit	
04	Disable	0	0	0	0	502	1	1000	ms	0	0	0	TCP	Submit	
05	Disable	0	0	0	0	502	1	1000	ms	0	0	0	TCP	Submit	

Figure 5-1.6

5.2 Two Modules Pushing the Local DI to each other (1-to-1, Push mode)

Step 1: Connect the device to a Network, a PC and a Power supply.

Confirm that the PETL/tET/tPET series modules are functioning correctly. Refer to [Chapter 3 “Getting Started”](#) for more details. An example configuration shown below:

Note that tPET-P2POR2 and tPET-PD2POR2 modules are used in this example.

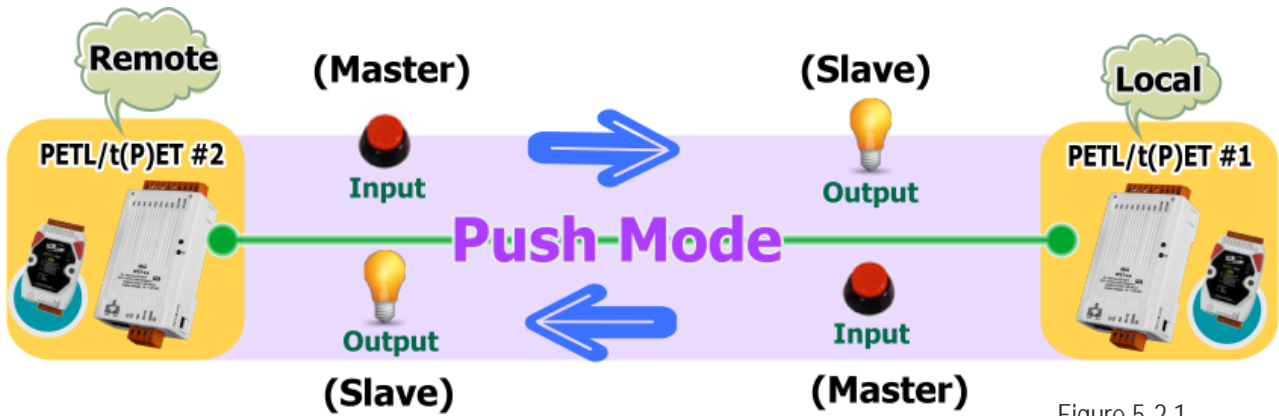

Figure 5-2.1

Step 2: Configure the Ethernet Settings

Contact your Network Administrator to obtain the correct network configuration information for the ET-2200 series modules (e.g., tPET-P2POR2 #1 and tPET-PD2POR2 #2), such as the IP Address, Subnet Mask, and Gateway details. Refer to [Section 3.4 “Using the eSearch Utility to assign a new IP”](#) for more details.

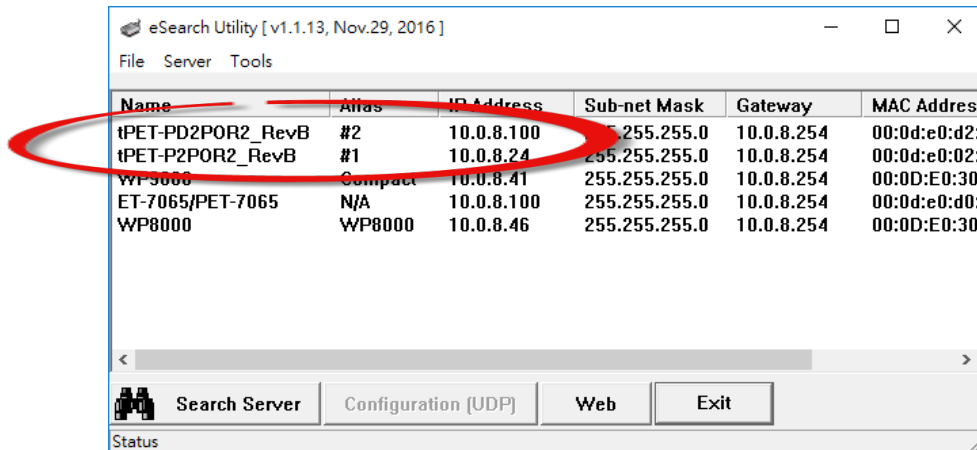

Figure 5-2.2

Step 3: Configure the I/O Pair connection on the tPET-P2POR2 #1 module

1. In the eSearch Utility, select **tPET-P2POR2 #1 module** and then click the **“Web”** button to launch the browser program and connect to the web server.
2. Enter the password in the Login password field (**the default password is “Admin”**), and then click the **“Submit”** button to display the configuration page.
3. Click the **“Pair”** tab to display the I/O Pair-connection Settings page.

Refer to [Figures 5-1.3 to 5-1.4](#) for illustrations of how to perform the above procedure.

4. In the “I/O Pair-connection Settings”, select **“PUSH”** from the **“Mode”** drop-down options.
5. Enter the **IP address for tPET-PD2POR2 #2 module** in the **“Remote IP”** field.
6. Enter the **TCP Port for tPET-PD2POR2 #2 module** in the **“Remote Port”** field.
7. Enter a **DI Count Value for tPET-P2POR2 #1 module** in the **“DI Count”** field (Local DI to Remote DO).

For example, enter **“1”** in the **“DI Count”** field. This means **DI x1 of tPET-P2POR2 #1 module** is mapped to **DO1 x of tPET-PD2POR2 #2 module**.

8. Select **Modbus protocol (e.g., “TCP”)** from the **“TCP/UDP”** drop-down options.
9. Click the **“Submit”** button to complete the configuration.

POLL Mode: (Remote DI -> Local DO)

PUSH Mode: (Local DI -> Remote DO)

Function in "BLUE" text available in "PUSH" Mode Only

| 1~5 | 6~10 | 11~12 |

#	Mode	Remote IP				Remote Port	Net ID	Scan Time	DI Count	DI Addr	DO Addr	TCP/UDP	Update
01	PUSH ▾	10	0	8	100	502	1	1000 ms	1	0	0	TCP ▾	Submit
02	Disable ▾	0	0	0	0	502	1	1000 ms	0	0	0	TCP ▾	Submit
03	Disable ▾	0	0	0	0	502	1	1000 ms	0	0	0	TCP ▾	Submit
04	Disable ▾	0	0	0	0	502	1	1000 ms	0	0	0	TCP ▾	Submit
05	Disable ▾	0	0	0	0	502	1	1000 ms	0	0	0	TCP ▾	Submit

Figure 5-2.3

Step 4: Configure the I/O Pair connection on the tPET-PD2POR2 #2 module

1. In the eSearch Utility, select **tPET-PD2POR2 #2 module** and then click the **“Web”** button to launch the browser program and connect to the web server.
2. Enter the password in the Login password field (**the default password is “Admin”**), and then click the **“Submit”** button to display the configuration page.
3. Click the **“Pair”** tab to display the I/O Pair-connection Settings page.

Refer to [Figures 5-1.3 to 5-1.4](#) for illustrations of how to perform the above procedure.

4. In the “I/O Pair-connection Settings”, select **“PUSH”** from the **“Mode”** drop-down options.
5. Enter the **IP address for tPET-P2POR2 #1 module** in the **“Remote IP”** field.
6. Enter the **TCP Port for tPET-P2POR2 #1 module** in the **“Remote Port”** field.
7. Enter a **DI Count Value for tPET-PD2POR2 #2 module** in the **“DI Count”** field (Local DI to Remote DO).

For example, enter **“1”** in the **“DI Count”** field. This means **DI x1 of tPET-PD2POR2 #2 module** is mapped to **DO1 x of tPET-P2POR2 #1 module**.

8. Select **Modbus protocol (e.g., “TCP”)** from the **“TCP/UDP”** drop-down options.
9. Click the **“Submit”** button to complete the configuration.

POLL Mode: (Remote DI -> Local DO)

PUSH Mode: (Local DI -> Remote DO)

Function in "BLUE" text available in "PUSH" Mode Only

| 1~5 | 6~10 | 11~12 |

#	Mode	Remote IP	Remote Port	Net ID	Scan Time	DI Count	DI Addr	DO Addr	TCP/UDP	Update
01	PUSH ▼	10 . 0 . 8 . 24	502	1	1000 ms	1	0	0	TCP ▼	Submit
02	Disable ▼	0 . 0 . 0 . 0	502	1	1000 ms	0	0	0	TCP ▼	Submit
03	Disable ▼	0 . 0 . 0 . 0	502	1	1000 ms	0	0	0	TCP ▼	Submit
04	Disable ▼	0 . 0 . 0 . 0	502	1	1000 ms	0	0	0	TCP ▼	Submit
05	Disable ▼	0 . 0 . 0 . 0	502	1	1000 ms	0	0	0	TCP ▼	Submit

Figure 5-2.4

5.3 Several Modules Polling the Remote DI (M-to-1) (Polling Mode)

Step 1: Connect the device to a Network, a PC and a Power supply.

Confirm that the PETL/tET/tPET series modules and remote slave device are functioning correctly. Refer to [Chapter 3 “Getting Started”](#) for more details. An example configuration shown below:

Note that tPET-P2POR2, tPET-PD2POR2 and ET-2260 modules are used in this example.

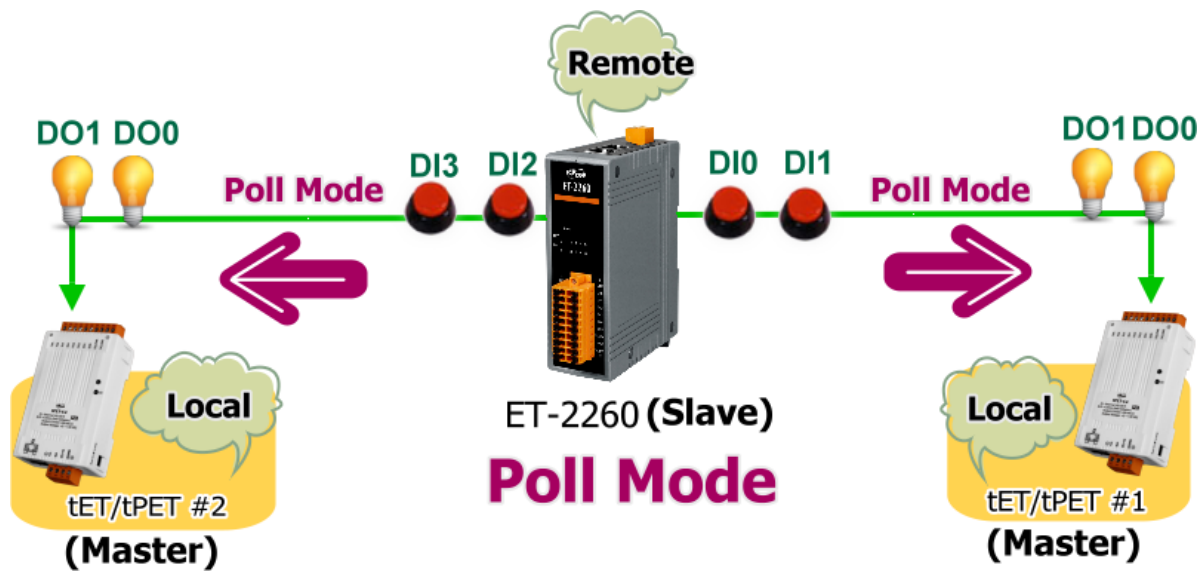

Figure 5-3.1

Step 2: Configure the Ethernet Settings

Contact your Network Administrator to obtain the correct network configuration information for the PETL/tET/tPET series modules and remote slave device (e.g., tPET-P2POR2 #1, tPET-PD2POR2 #2 and ET-2260), such as the IP Address, Subnet Mask, and Gateway details. Refer to [Section 3.4 “Using the eSearch Utility to assign a new IP”](#) for more details.

Name	Alias	IP Address	Sub-net Mask	Gateway	MAC Address
tPET-PD2POR2_RevB	#2	10.0.8.100	255.255.255.0	10.0.8.254	00:0d:e0:d2:
tPET-P2POR2_RevB	#1	10.0.8.24	255.255.255.0	10.0.8.254	00:0d:e0:02:
ET-2260	EtherIO	10.0.8.26	255.255.255.0	10.0.8.254	00:0d:e0:02:

The screenshot shows the eSearch Utility [v1.1.13, Nov.29, 2016] window. It has a menu bar with File, Server, and Tools. Below the menu bar is a table with the following data:

Figure 5-3.2

Step 3: Configure the I/O Pair connection on the tPET-P2POR2 #1 module

1. In the eSearch Utility, select **tPET-P2POR2 #1 module** and then click the “**Web**” button to launch the browser program and connect to the web server.
2. Enter the password in the Login password field (**the default password is “Admin”**), and then click the “**Submit**” button to display the configuration page.
3. Click the “**Pair**” tab to display the I/O Pair-connection Settings page.

Refer to [Figures 5-1.3 to 5-1.4](#) for illustrations of how to perform the above procedure.

4. In the “I/O Pair-connection Settings”, select “**POLL**” from the “**Mode**” drop-down options.
5. Enter the **IP address for remote slave device (e.g., ET-2260)** in the “**Remote IP**” field.
6. Enter the **TCP Port for remote slave device (e.g., ET-2260)** in the “**Remote Port**” field.
7. Enter a **DI Count Value for remote slave device (e.g., ET-2260)** in the “**DI Count**” field (Remote DI to Local DO).

For example, enter “**2**” in the “**DI Count**” field. This means **DI x2 of the ET-2260 module** is mapped to **DO x2 of tPET-P2POR2 #1 module**.

8. Enter the **DI address for remote slave device (e.g., ET-2260)** in the “**DI Addr**” field (Remote DI to Local DO).

For example, enter “**0**” in the “**DI Addr**” field. This means **DI addresses DI0 and DI1 of the ET-2260 module** are mapped to **DO x2 of tPET-P2POR2 #1 module**.

POLL Mode: (Remote DI -> Local DO)

PUSH Mode: (Local DI -> Remote DO)

Function in "BLUE" text available in "PUSH" Mode Only

| 1~5 | 6~10 | 11~12 |

#	Mode	Remote IP	Remote Port	Net ID	Scan Time	DI Count	DI Addr	DO Addr	TCP/UDP	Update
01	POLL ▼	10 0 8 26	502	1	1000 ms	2	0	0	TCP ▼	Submit
02	Disable ▼	0 0 0 0	502	1	1000 ms	0	0	0	TCP ▼	Submit
03	Disable ▼	0 0 0 0	502	1	1000 ms	0	0	0	TCP ▼	Submit
04	Disable ▼	0 0 0 0	502	1	1000 ms	0	0	0	TCP ▼	Submit
05	Disable ▼	0 0 0 0	502	1	1000 ms	0	0	0	TCP ▼	Submit

Figure 5-3.3

Step 4: Configure the I/O Pair connection on the tPET-PD2POR2 #2 module

1. In the eSearch Utility, select **tPET-PD2POR2 #2 module** and then click the “**Web**” button to launch the browser program and connect to the web server.
2. Enter the password in the Login password field (**the default password is “Admin”**), and then click the “**Submit**” button to display the configuration page.
3. Click the “**Pair**” tab to display the I/O Pair-connection Settings page.

Refer to [Figures 5-1.3 to 5-1.4](#) for illustrations of how to perform the above procedure.

4. In the “I/O Pair-connection Settings”, select “**POLL**” from the “**Mode**” drop-down options.
5. Enter the **IP address for remote slave device (e.g., ET-2260)** in the “**Remote IP**” field.
6. Enter the **TCP Port for remote slave device (e.g., ET-2260)** in the “**Remote Port**” field.
7. Enter a **DI Count Value for remote slave device (e.g., ET-2260)** in the “**DI Count**” field (Remote DI to Local DO).

For example, enter “**2**” in the “**DI Count**” field. This means **DI x2 of the ET-2260 module** is mapped to **DO x2 of tPET-PD2POR2 #2 module**.

8. Enter the **DI address for remote slave device (e.g., ET-2260)** in the “**DI Addr**” field (Remote DI to Local DO).

For example, enter “**2**” in the “**DI Addr**” field. This means **DI addresses DI2 and DI3 of the ET-2260 module** are mapped to **DO x2 of tPET-PD2POR2 #2 module**.

9. Click the “**Submit**” button to complete the configuration.

POLL Mode: (Remote DI -> Local DO)

PUSH Mode: (Local DI -> Remote DO)

Function in "BLUE" text available in "PUSH" Mode Only

| 1~5 | 6~10 | 11~12 |

#	Mode	Remote IP				Remote Port	Net ID	Scan Time	DI Count	DI Addr	DO Addr	TCP/UDP	Update
01	POLL ▾	10	0	8	26	502	1	1000 ms	2	2	0	TCP ▾	Submit
02	Disable ▾	0	0	0	0	502	1	1000 ms	0	0	0	TCP ▾	Submit
03	Disable ▾	0	0	0	0	502	1	1000 ms	0	0	0	TCP ▾	Submit
04	Disable ▾	0	0	0	0	502	1	1000 ms	0	0	0	TCP ▾	Submit
05	Disable ▾	0	0	0	0	502	1	1000 ms	0	0	0	TCP ▾	Submit

Figure 5-3.4

5.4 Several Modules Pushing the Local DI (M-to-1) (Push Mode)

Step 1: Connect the device to a Network, a PC and a Power supply.

Confirm that the PETL/tET/tPET series modules and remote slave device are functioning correctly. Refer to [Chapter 3. "Getting Started"](#) for more details. An example configuration shown below:

Note that tPET-P2POR2, tPET-PD2POR2 and ET-2260 modules are used in this example.

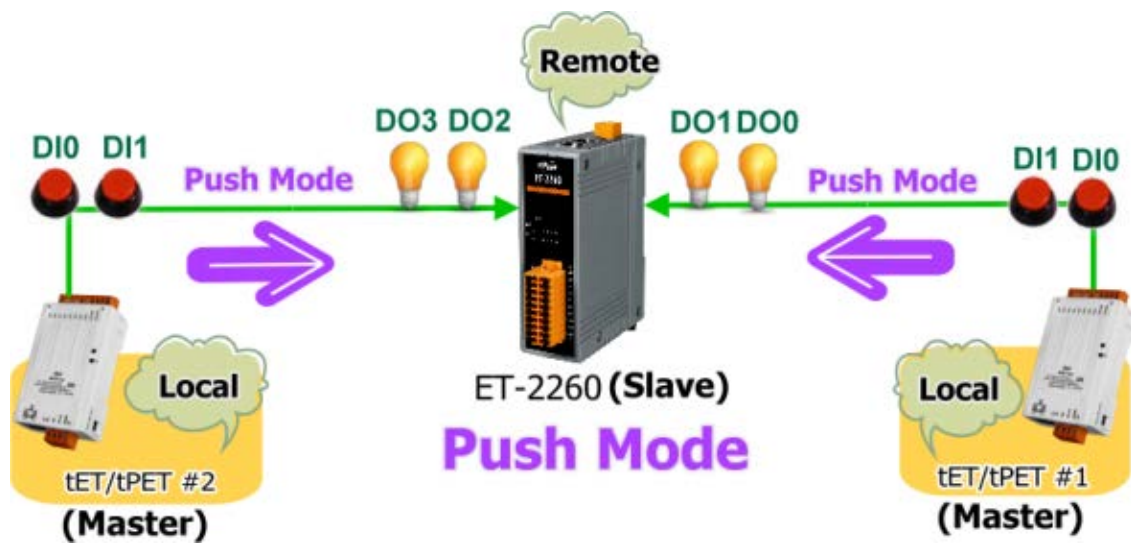

Figure 5-4.1

Step 2: Configure the Ethernet Settings

Contact your Network Administrator to obtain the correct network configuration information for the PETL/tET/tPET series modules and remote slave device (e.g., tPET-P2POR2 #1, tPET-PD2POR2 #2 and ET-2260), such as the IP Address, Subnet Mask, and Gateway details. Refer to [Section 3.4 "Using the eSearch Utility to assign a new IP"](#) for more details.

The screenshot shows the 'eSearch Utility' window with a table of network settings. The table has columns for Name, Alias, IP Address, Sub-net Mask, Gateway, and MAC Address. The data rows are as follows:

Name	Alias	IP Address	Sub-net Mask	Gateway	MAC Address
tPET-PD2POR2_RevB	#2	10.0.8.100	255.255.255.0	10.0.8.254	00:0d:e0:d2:
tPET-P2POR2_RevB	#1	10.0.8.24	255.255.255.0	10.0.8.254	00:0d:e0:02:
ET-2260	EtherIO	10.0.8.26	255.255.255.0	10.0.8.254	00:0d:e0:02:

At the bottom of the window, there are buttons for 'Search Server', 'Configuration (UDP)', 'Web', and 'Exit'. The status bar at the very bottom shows 'Status'.

Figure 5-4.2

Step 3: Configure the I/O Pair connection on the tPET-P2POR2 #1 module

1. In the eSearch Utility, select **tPET-P2POR2 #1 module** and then click the **“Web”** button to launch the browser program and connect to the web server.
2. Enter the password in the Login password field (**the default password is “Admin”**), and then click the **“Submit”** button to display the configuration page.
3. Click the **“Pair Connection”** tab to display the I/O Pair-connection Settings page.

Refer to [Figures 5-1.3 to 5-1.4](#) for illustrations of how to perform the above procedure.

4. In the “I/O Pair-connection Settings”, select **“PSUH”** from the **“Mode”** drop-down options.
5. Enter the **IP address for remote slave device (e.g., ET-2260)** in the **“Remote IP”** field.
6. Enter the **TCP Port for remote slave device (e.g., ET-2260)** in the **“Remote Port”** field.
7. Enter a **DI Count Value for tPET-P2POR2 #1 module** in the **“DI Count”** field (Local DI to Remote DO).

For example, enter **“2”** in the **“DI Count”** field. This means **DI x2 of the tPET-P2POR2 #1 module** is mapped to **DO x2 of the ET-2260 module**.

8. Enter the **DO address for remote slave device (e.g., ET-2260)** in the **“DO Addr”** field (Local DI to Remote DO).

For example, enter **“0”** in the **“DO Addr”** field. This means **DO addresses DO0 and DO1 of the ET-2260 module** are mapped to **DI x2 of tPET-P2POR2 #1 module**.

9. Select **Modbus protocol (e.g., “TCP”)** from the **“TCP/UDP”** drop-down options.
10. Click the **“Submit”** button to complete the configuration.

POLL Mode: (Remote DI -> Local DO)

PUSH Mode: (Local DI -> Remote DO)

Function in "BLUE" text available in "PUSH" Mode Only

| 1~5 | 6~10 | 11~12 |

#	Mode	Remote IP				Remote Port	Net ID	Scan Time	DI Count	DI Addr	DO Addr	TCP/UDP	Update
01	PUSH ▾	10	0	8	26	502	1	1000 ms	2	0	0	TCP ▾	Submit
02	Disable ▾	0	0	0	0	502	1	1000 ms	0	0	0	TCP ▾	Submit
03	Disable ▾	0	0	0	0	502	1	1000 ms	0	0	0	TCP ▾	Submit
04	Disable ▾	0	0	0	0	502	1	1000 ms	0	0	0	TCP ▾	Submit
05	Disable ▾	0	0	0	0	502	1	1000 ms	0	0	0	TCP ▾	Submit

Figure 5-4.3

Step 4: Configure the I/O Pair connection on the tPET-PD2POR2 #2 module

1. In the eSearch Utility, select **tPET-PD2POR2 #2 module** and then click the **“Web”** button to launch the browser program and connect to the web server.
2. Enter the password in the Login password field (**the default password is “Admin”**), and then click the **“Submit”** button to display the configuration page.
3. Click the **“Pair Connection”** tab to display the I/O Pair-connection Settings page.

Refer to [Figures 5-1.3 to 5-1.4](#) for illustrations of how to perform the above procedure.

4. In the “I/O Pair-connection Settings”, select **“PSUH”** from the **“Mode”** drop-down options.
5. Enter the **IP address for remote slave device (e.g., ET-2260)** in the **“Remote IP”** field.
6. Enter the **TCP Port for remote slave device (e.g., ET-2260)** in the **“Remote Port”** field.
7. Enter a **DI Count Value for tPET-PD2POR2 #2 module** in the **“DI Count”** field (Local DI to Remote DO).

For example, enter **“2”** in the **“DI Count”** field. This means **DI x2 of the tPET-PD2POR2 #2 module** is mapped to **DO x2 of the ET-2260 module**.

8. Enter the **DO address for remote slave device (e.g., ET-2260)** in the **“DO Addr”** field (Local DI to Remote DO).

For example, enter **“2”** in the **“DO Addr”** field. This means **DO addresses DO2 and DO3 of the ET-2260 module** are mapped to **DI x2 of tPET-PD2POR2 #2 module**.

9. Select **Modbus protocol (e.g., “TCP”)** from the **“TCP/UDP”** drop-down options.
10. Click the **“Submit”** button to complete the configuration.

POLL Mode: (Remote DI -> Local DO)

PUSH Mode: (Local DI -> Remote DO)

Function in "BLUE" text available in "PUSH" Mode Only

| 1~5 | 6~10 | 11~12 |

#	Mode	Remote IP				Remote Port	Net ID	Scan Time	DI Count	DI Addr	DO Addr	TCP/UDP	Update
01	PUSH ▼	10	0	8	26	502	1	1000 ms	2	0	2	TCP ▼	Submit
02	Disable ▼	0	0	0	0	502	1	1000 ms	0	0	0	TCP ▼	Submit
03	Disable ▼	0	0	0	0	502	1	1000 ms	0	0	0	TCP ▼	Submit
04	Disable ▼	0	0	0	0	502	1	1000 ms	0	0	0	TCP ▼	Submit
05	Disable ▼	0	0	0	0	502	1	1000 ms	0	0	0	TCP ▼	Submit

Figure 5-4.4

6. Modbus Information

The PETL/tET/tPET series is a family of IP-based Modbus I/O devices that allow you to remotely control DI/DO terminals via an Ethernet connection and uses a master-slave communication technique in which only one device (the master) can initiate a transaction (called queries), while other devices (slaves) respond by either supplying the requested data to the master, or by taking the action requested in the query.

Most SCADA (Supervisory Control and Data Acquisition) and HMI software, such as Citect (Schneider Electric), ICONICS, iFIX, InduSoft, Intouch, Entivity Studio, Entivity Live, Entivity VLC, Trace Mode, Wizcon (ELUTIONS), and Wonderware, etc. can be used to easily integrate serial devices via the Modbus protocol.

Modbus/TCP master applications can also be developed using any programming language, such as VB, C# and so on.

ICP DAS provides the Modbus SDK that allows development of Modbus applications on a PC.

The relevant demo programs and SDK can be obtained from the following locations:

VB Demo : http://ftp.icpdas.com/pub/cd/6000cd/napdos/et7000/demo/pc_client/

.Net demo and SDK : <http://ftp.icpdas.com/pub/cd/8000cd/napdos/modbus/nmodbus/>

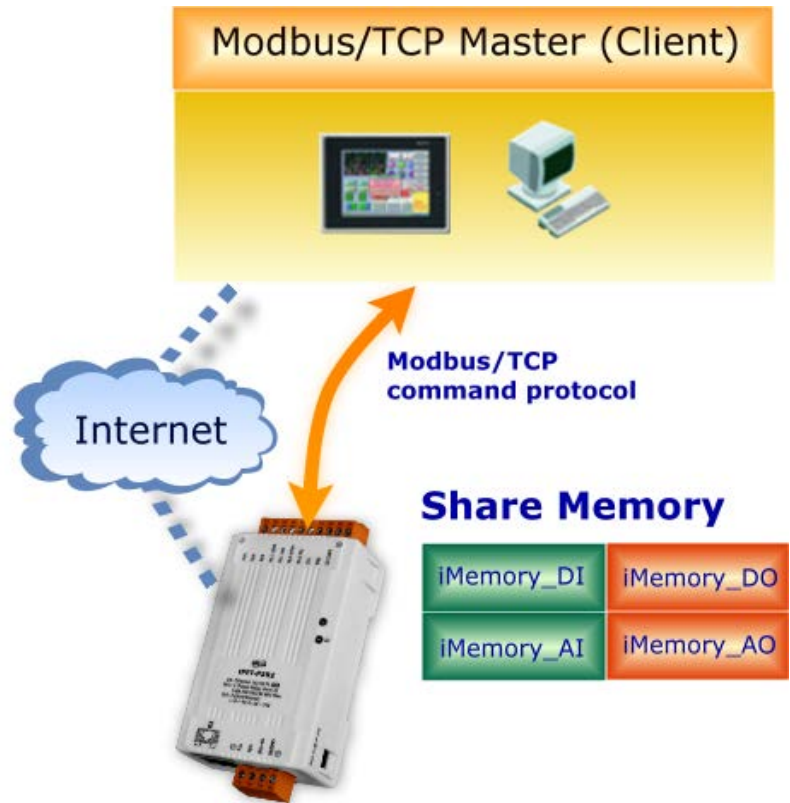

6.1 What is Modbus TCP/IP?

Modbus is a communication protocol that was developed by Modicon Inc. in 1979, and was originally designed for use with Modicon controllers. Detailed information regarding the Modbus protocol can be found at: <http://www.modbus.org>.

The different versions of the Modbus protocol used today include Modbus RTU, which is based on serial communication interfaces such as RS-485 and RS-232, Modbus ASCII and Modbus TCP, which uses the Modbus RTU protocol embedded into TCP packets.

Modbus TCP is an internet protocol. The protocol embeds a Modbus frame into a TCP frame so that a connection oriented approach is obtained, thereby making it more reliable. The master queries the slave and the slave responds with a reply. The protocol is open and, hence, highly scalable.

6.2 Modbus Message Structure

Modbus devices communicate using a master-slave (client-server) technique in which only one device (the master/client) can initiate transactions (called queries). The other devices (slaves/servers) respond by either supplying the requested data to the master, or by taking the action requested in the query.

A query from a master will consist of a slave address (or broadcast address), a function code defining the requested action, any required data, and an error checking field. A response from a slave consists of fields confirming the action taken, any data to be returned, and an error checking field.

➤ The Modbus/TCP Message Structure

Bytes 00 - 05	Bytes 06 - 11
6-byte header	RTU Data

➤ **The Leading 6 bytes of a Modbus/TCP Protocol Query**

Byte 00	Byte 01	Byte 02	Byte 03	Byte 04	Byte 05
Transaction identifier		Protocol identifier		Length Field (upper byte)	Length Field (lower byte)

Transaction identifier = Assigned by the Modbus/TCP master (client)

Protocol identifier = 0

Length field (upper byte) = 0 (since all messages are smaller than 256)

Length field (lower byte) = The number of following RTU data bytes

➤ **RTU Data Structure**

Byte 06	Byte 07	Bytes 08-09	Bytes 10-11
Net ID (Station Number)	Function Code	Data Field	
		Reference Number (Address Mapping)	Number of Points

1. **Net ID** specifies the address of the receiver (Modbus/TCP slave).
2. **Function Code** specifies the message type.
3. **Data Field** is the data block.

1. Net ID (Station Number)

The first byte in the frame structure of a Modbus RTU query is the receiver's address. A valid address is in the range of 0 to 247. Address 0 is used for general broadcast, while addresses 1 to 247 are given to individual Modbus devices.

2. Function Code

The second byte in the frame structure of a Modbus RTU query is the function code, which describes what the slave device is required to do. Valid function codes are between 1 and 255. To answer the query, the slave device uses the same function code as contained in the request. The highest bit of the function code will only be set to '1' if an error occurs in the system. In this way, the master will know whether the message has been transmitted correctly or not.

Code	Function	Reference (Address)
01 (0x01)	Read the Status of the Coils (Readback DOs)	0xxxx
02 (0x02)	Read the Status of the Input(Reads DIs)	1xxxx
03 (0x03)	Read the Holding Registers (Readback AOs)	4xxxx
04 (0x04)	Read the Input Registers (Reads AIs)	3xxxx
05 (0x05)	Force a Single Coil (Writes DO)	0xxxx
06 (0x06)	Preset a Single Register (Writes AO)	4xxxx
15 (0x0F)	Force Multiple Coils (Writes DOs)	0xxxx
16 (0x10)	Preset Multiple Registers (Writes AOs)	4xxxx

3. Data Field

Data is transmitted in 8-, 16- and 32-bit format. The data for 16-bit registers is transmitted in high-byte first format. For example: 0x0A0B ==> 0x0A, 0x0B. The data for 32-bit registers is transmitted as two 16-bit registers, and is low-word first. For example: 0x0A0B0C0D ==> 0x0C, 0x0D, 0x0A, 0x0B.

The data field of messages sent between a master and a slave contains additional information about the action to be taken by the master or any information requested by the slave. If the master does not require this information, the data field can be empty.

Reference (Address)	Description
0xxxx	<p><u>Read/Write Discrete Outputs or Coils.</u></p> <p>A 0x reference address is used to output device data to a digital output channel.</p>
1xxxx	<p><u>Read Discrete Inputs.</u></p> <p>The ON/OFF status of a 1x reference address is controlled by the corresponding digital input channel.</p>
3xxxx	<p><u>Read Input Registers.</u></p> <p>A 3x reference register contains a 16-bit number received from an external source, e.g. an analog signal.</p>
4xxxx	<p><u>Read/Write Output or Holding Registers.</u></p> <p>A 4x register is used to store 16bits of numerical data (binary or decimal), or to send the data from the CPU to an output channel.</p>

 For more details regarding Address Mapping (Reference Number), refer to [Section 6.3 “Modbus Register Table”](#).

01(0x01) Read the Status of the Coils (Readback DOs)

This function code is used to read either the current status of the coils or the current digital output readback value from the PETL/tET/tPET module.

[Request]

Byte	Description	Size	Value
00	Net ID (Station Number)	1 Byte	1 to 247
01	Function Code	1 Byte	0x01
02-03	Starting DO Address	2 Bytes	Refer to the Modbus Address Table for the PETL/tET/tPET series. (Section 6.3 Modbus Register Table) Byte 02 = high byte Byte 03 = low byte
04-05	Number of Points (Channels)	2 Bytes	Byte 04 = high byte Byte 05 = low byte

[Response]

Byte	Description	Size	Value
00	Net ID (Station Number)	1 Byte	1 to 247
01	Function Code	1 Byte	0x01
02	Byte Count	1 Byte	Byte Count of the Response ($n = (\text{Points}+7)/8$)
03	Data	n Bytes	n= 1; Byte 03 = data bit 7 to 0 n= 2; Byte 04 = data bit 15 to 8 n= m; Byte m+2 = data bit (8m-1) to 8(m-1)

[Error Response]

Byte	Description	Size	Value
00	Net ID (Station Number)	1 Byte	1 to 247
01	Function Code	1 Byte	0x81
02	Exception Code	1 Byte	Refer to the Modbus Standard Specifications for more details

Example: Function 01 (0x01), Readback DOs

	[Leading 6 bytes]	[Request]
Command:	<u>01 02 00 00 00 06</u>	<u>01 01 00 00 00 02</u>
	[Leading 6 bytes]	[Response]
Response:	<u>01 02 00 00 00 04</u>	<u>01 01 01 03</u>
Reads the digital output value		

A description of the command and response is as follows:

Command:	[Leading 6 bytes]	
	Bytes 00-03	01 02 00 00 (Message Number)
	Bytes 04-05	00 06 (Number of bytes remaining in this frame)
	[Request]	
	Byte 00	01 (Net ID)
	Byte 01	01 (Function Code)
	Byte 02-03	00 00 (Starting DO Address)
	Byte 04-05	00 02 (Number of Points)

Response:	[Leading 6 bytes]	
	Bytes 00-03	01 02 00 00 (Message Number)
	Bytes 04-05	00 04 (Number of bytes remaining in this frame)
	[Response]	
	Byte 00	01 (Net ID)
	Byte 01	01 (Function Code)
	Byte 02	01 (Byte Count of the Response)
	Byte 03	03 (Value for DO1 to DO0)

02(0x02) Read the Status of the Input (Read DIs)

This function code is used to read the current digital input value from the PETL/tET/tPETL module.

[Request]

Byte	Description	Size	Value
00	Net ID (Station Number)	1 Byte	1 to 247
01	Function Code	1 Byte	0x02
02-03	Starting DI Address	2 Bytes	Refer to the Modbus Address Table for the PETL/tET/tPET series. (Section 6.3 Modbus Register Table) Byte 02 = high byte Byte 03 = low byte
04-05	Number of Points (Channels)	2 Bytes	Byte 04 = high byte Byte 05 = low byte

[Response]

Byte	Description	Size	Value
00	Net ID (Station Number)	1 Byte	1 to 247
01	Function Code	1 Byte	0x02
02	Byte Count	1 Byte	Byte Count of Response ($n = (\text{Points} + 7) / 8$)
03	Data	n Bytes	n= 1; Byte 03 = data bit 7 to 0 n= 2; Byte 04 = data bit 15 to 8 n= m; Byte m+2 = data bit (8m-1) to 8(m-1)

[Error Response]

Byte	Description	Size	Value
00	Net ID (Station Number)	1 Byte	1 to 247
01	Function Code	1 Byte	0x82
02	Exception Code	1 Byte	Refer to the Modbus Standard Specifications for more details

Example: Function 02 (0x02), Read DIs

	[Leading 6 bytes]	[Request]
Command:	<u>01 02 00 00 00 06</u>	<u>01 02 00 00 00 02</u>
	[Leading 6 bytes]	[Response]
Response:	<u>01 02 00 00 00 04</u>	<u>01 02 01 03</u>

Reads the digital input value

A description of the command and response is as follows:

Command:	[Leading 6 bytes]	
	Bytes 00-03	01 02 00 00 (Message Number)
	Bytes 04-05	00 06 (Number of bytes remaining in this frame)
	[Request]	
	Byte 00	01 (Net ID)
	Byte 01	02 (Function Code)
	Bytes 02-03	00 00 (Starting DI Address)
	Bytes 04-05	00 02 (Number of Points)

Response:	[Leading 6 bytes]	
	Bytes 00-03	01 02 00 00 (Message Number)
	Bytes 04-05	00 04 (Number of bytes remaining in this frame)
	[Response]	
	Byte 00	01 (Net ID)
	Byte 01	02 (Function Code)
	Byte 02	01 (Byte Count of the Response)
	Byte 03	03 (Value for DI1 to DI0)

03(0x03) Read the Holding Registers (Readback AOs)

This function code is used to readback either the current values in the holding registers or the analog output value from the PETL/tET/tPET module. These registers are also used to store the preset values for the digital counter, the host watchdog timer, the module name and the TCP timeout, etc.

[Request]

Byte	Description	Size	Value
00	Net ID (Station Number)	1 Byte	1 to 247
01	Function Code	1 Byte	0x03
02-03	Starting AO Address	2 Bytes	Refer to the Modbus Address Table for the PETL/tET/tPET series. (Section 6.3 Modbus Register Table) Byte 02 = high byte Byte 03 = low byte
04-05	Number of 16-bit Registers (Channels)	2 Bytes	Word Count Byte 04 = high byte Byte 05 = low byte

[Response]

Byte	Description	Size	Value
00	Net ID (Station Number)	1 Byte	1 to 247
01	Function Code	1 Byte	0x03
02	Byte Count	1 Byte	Byte Count of the Response (n=Points x 2 Bytes)
03~	Register Values	n Bytes	Register Values n= 2; Byte 03 = high byte Byte 04 = low byte n= m; Byte 03 = high byte Byte 04 = low byte Byte m+1 = high byte Byte m+2 = low byte

[Error Response]

Byte	Description	Size	Value
00	Net ID (Station Number)	1 Byte	1 to 247
01	Function Code	1 Byte	0x83
02	Exception Code	1 Byte	Refer to the Modbus Standard Specifications for more details

Example: Function 03 (0x03), Read AOs

	[Leading 6 bytes]	[Request]
Command:	<u>01 02 00 00 00 06</u>	<u>01 03 01 03 00 02</u>
	[Leading 6 bytes]	[Response]
Response:	<u>01 02 00 00 00 07</u>	<u>01 03 0450 32 41 32</u>

Reads the name of the module for the tPET-P2A2

A description of the command and response is as follows:

Command:	[Leading 6 bytes]
Bytes 00-03	01 02 00 00 (Message Number)
Bytes 04-05	00 06 (Number of bytes remaining in this frame)
	[Request]
Byte 00	01 (Net ID)
Byte 01	03 (Function Code)
Bytes 02-03	01 03 (Starting AO Address)
Bytes 04-05	00 02 (Number of Points)

Response:	[Leading 6 bytes]
Bytes 00-03	01 02 00 00 (Message Number)
Bytes 04-05	00 07 (Number of bytes remaining in this frame)
	[Response]
Byte 00	01 (Net ID)
Byte 01	03 (Function Code)
Byte 02	04 (Byte Count of the Response)
Bytes 03-04	50 32 (The low word for the module name: The ASCII code "0x50, 0x32" represents the characters "P" and "2")
Byte 05-06	41 32 (The high word for the module name: The ASCII code "0x41, 0x32" represents the characters "A" and "2")

04(0x04) Read the Input Registers (Read AIs)

This function code is used to read either the input registers or the current analog input value from the PETL/tET/tPET module.

These registers are also used to store the current value for the digital counter, the number of DI channels and the number of DO channels, etc.

[Request]

Byte	Description	Size	Value
00	Net ID (Station Number)	1 Byte	1 to 247
01	Function Code	1 Byte	0x04
02-03	Starting AI Address	2 Bytes	Refer to the Modbus Address Table for the PETL/tET/tPET series. (Section 6.3 Modbus Register Table) Byte 02 = high byte Byte 03 = low byte
04-05	Number of 16-bit Registers (Channels)	2 Bytes	Word Count Byte 04 = high byte Byte 05 = low byte

[Response]

Byte	Description	Size	Value
00	Net ID (Station Number)	1 Byte	1 to 247
01	Function Code	1 Byte	0x04
02	Byte Count	1 Byte	Byte Count of the Response (n=Points x 2 Bytes)
03~	Register Values	n Bytes	Register Values n= 2; Byte 03 = high byte Byte 04 = low byte n= m; Byte 03 = high byte Byte 04 = low byte Byte m+1 = high byte Byte m+2 = low byte

[Error Response]

Byte	Description	Size	Value
00	Net ID (Station Number)	1 Byte	1 to 247
01	Function Code	1 Byte	0x84
02	Exception Code	1 Byte	Refer to the Modbus Standard Specifications for more details.

Example: Function 04 (0x04), Read AIs

	[Leading 6 bytes]	[Request]
Command:	<u>01 02 00 00 00 06</u>	<u>01 04 00 64 00 01</u>
	[Leading 6 bytes]	[Response]
Response:	<u>01 02 00 00 00 05</u>	<u>01 04 02 00 02</u>

Reads the number of the DI channels on the tPET-P2A2

A description of the command and response is as follows:

Command:	[Leading 6 bytes]	
	Bytes 00-03	01 02 00 00 (Message Number)
	Bytes 04-05	00 06 (Number of bytes remaining in this frame)
	[Request]	
	Byte 00	01 (Net ID)
	Byte 01	04 (Function Code)
	Bytes 02-03	0064 (Starting AI Address)
	Bytes 04-05	00 01 (Number of 16-bit Registers)

Response:	[Leading 6 bytes]	
	Bytes 00-03	01 02 00 00 (Message Number)
	Bytes 04-05	00 05 (Number of bytes remaining in this frame)
	[Response]	
	Byte 00	01 (Net ID)
	Byte 01	04 (Function Code)
	Byte 02	02 (Byte Count of the Response)
	Bytes 03-04	00 02 (Number of DI Channels on the tPET-P2A2)

05(0x05) Force a Single Coil (Write DO)

This function code is used to set the status of a single coil or a single digital output value for the PETL/tET/tPET module.

[Request]

Byte	Description	Size	Value
00	Net ID (Station Number)	1 Byte	1 to 247
01	Function Code	1 Byte	0x05
02-03	DO Address	2 Bytes	Refer to the Modbus Address Table for the PETL/tET/tPET series. (Section 6.3 Modbus Register Table) Byte 02 = high byte Byte 03 = low byte
04-05	Output Value	2 Bytes	0xFF 00 sets the output to ON. 0x00 00 sets the output to OFF. All other values are invalid and will not affect the coil. Byte 04 = high byte Byte 05 = low byte

[Response]

Byte	Description	Size	Value
00	Net ID (Station Number)	1 Byte	1 to 247
01	Function Code	1 Byte	0x05
02-03	DO Address	2 Bytes	The value is the same as Bytes 02-03 of the Request
04-05	Output Value	2 Bytes	The value is the same as Bytes 04-05 of the Request

[Error Response]

Byte	Description	Size	Value
00	Net ID (Station Number)	1 Byte	1 to 247
01	Function Code	1 Byte	0x85
02	Exception Code	1 Byte	Refer to the Modbus Standard Specifications for more details.

Example: Function 05 (0x05), Write DO

	[Leading 6 bytes]	[Request]
Command:	<u>01 02 00 00 00 06</u>	<u>01 05 00 01 FF 00</u>
	[Leading 6 bytes]	[Response]
Response:	<u>01 02 00 00 00 06</u>	<u>01 05 00 01 FF 00</u>

Sets Channel DO1 to ON

A description of the command and response is as follows:

Command:	[Leading 6 bytes]	
	Bytes 00-03	01 02 00 00 (Message Number)
	Bytes 04-05	00 06 (Number of bytes remaining in this frame)
	[Request]	
	Byte 00	01 (Net ID)
	Byte 01	05 (Function Code)
	Bytes 02-03	00 01(DO Address)
	Bytes 04-05	FF00 (Sets the output to ON)

Response:	[Leading 6 bytes]	
	Bytes 00-03	01 02 00 00 (Message number)
	Bytes 04-05	00 06 (Number of bytes remaining in this frame)
	[Response]	
	Byte 00	01 (Net ID)
	Byte 01	05 (Function Code)
	Bytes 02-03	00 01 (DO Address)
	Bytes 04-05	FF 00 (Indicates that the DO has been set to ON)

06(0x06) Preset a Single Register (Write AO)

This function code is used to set a specific holding register to store the configuration values for the PETL/tET/tPET module.

[Request]

Byte	Description	Size	Value
00	Net ID (Station Number)	1 Byte	1 to 247
01	Function Code	1 Byte	0x06
02-03	AO Address	2 Bytes	Refer to the Modbus Address Table for the PETL/tET/tPET series. (Section 6.3 Modbus Register Table) Byte 02 = high byte Byte 03 = low byte
04-05	Register Value	2 Bytes	Register Value Byte 04 = high byte Byte 05 = low byte

[Response]

Byte	Description	Size	Value
00	Net ID (Station Number)	1 Byte	1 to 247
01	Function Code	1 Byte	0x06
02-03	AO Address	2 Bytes	The value is the same as Bytes 02-03 of the Request
04-05	Register Value	2 Bytes	The value is the same as Bytes 04-05 of the Request

[Error Response]

Byte	Description	Size	Value
00	Net ID (Station Number)	1 Byte	1 to 247
01	Function Code	1 Byte	0x86
02	Exception Code	1 Byte	Refer to the Modbus Standard Specifications for more details.

Example: Function 06 (0x06), Write AO

	[Leading 6 bytes]	[Request]
Command:	<u>01 02 00 00 00 06</u>	<u>01 06 01 08 00 3C</u>
	[Leading 6 bytes]	[Response]
Response:	<u>01 02 00 00 00 06</u>	<u>01 06 01 08 00 3C</u>

Sets the system timeout to 60 seconds

A description of the command and response is as follows:

Command:	[Leading 6 bytes]	
	Bytes 00-03	01 02 00 00 (Message Number)
	Bytes 04-05	00 06 (Number of bytes remaining in this frame)
	[Request]	
	Byte 00	01 (Net ID)
	Byte 01	06 (Function Code)
	Bytes 02-03	01 08 (AO Address)
	Bytes 04-05	00 3C (Sets the system timeout to 60 seconds)

Response:	[Leading 6 bytes]	
	Bytes 00-03	01 02 00 00 (Message Number)
	Bytes 04-05	00 06 (Number of bytes remaining in this frame)
	[Response]	
	Byte 00	01 (Net ID)
	Byte 01	06 (Function Code)
	Bytes 02-03	01 08 (AO Address)
	Bytes 04-05	00 3C (Indicates that the system timeout has been set to 60 seconds)

15(0x0F) Force Multiple Coils (Write DOs)

This function code is used to set multiple coils status or write multiple digital output values for the PETL/tET/tPET module.

[Request]

Byte	Description	Size	Value
00	Net ID (Station Number)	1 Byte	1 to 247
01	Function Code	1 Byte	0x0F
02-03	Starting DO Address	2 Bytes	Refer to the Modbus Address Table for PETL/tET/tPET series. (Section 6.3 Modbus Register Table) Byte 02 = high byte Byte 03 = low byte
04-05	Number of Output Channels (Points)	2 Bytes	Byte 04 = high byte Byte 05 = low byte
06	Byte count	1 Byte	$n = (\text{Points} + 7) / 8$
07	Output value	n Bytes	A bit corresponds to a channel. A value of 1 for a bit denotes that the channel is ON, while a value of 0 denotes that the channel is OFF. n= 1; Byte 07 = data bit 7 to 0 n= 2; Byte 08 = data bit 15 to 8 n= m; Byte m+6 = data bit (8m-1)to 8(m-1)

[Response]

Byte	Description	Size	Value
00	Net ID (Station Number)	1 Byte	1 to 247
01	Function Code	1 Byte	0x0F
02-03	Starting DO Address	2 Bytes	The value is the same as Bytes 02-03 of the Request
04-05	Number of Output Channels (Points)	2 Bytes	The value is the same as Bytes 04-05 of the Request

[Error Response]

Byte	Description	Size	Value
00	Net ID (Station Number)	1 Byte	1 to 247
01	Function Code	1 Byte	0x8F
02	Exception Code	1 Byte	Refer to the Modbus Standard Specifications for more details.

Example: Function 15 (0x0F), Write DOs

	[Leading 6 bytes]	[Request]
Command:	<u>01 02 00 00 00 08</u>	<u>01 0F 01 0B 00 02 01 03</u>
	[Leading 6 bytes]	[Response]
Response:	<u>01 02 00 00 00 06</u>	<u>01 0F 01 0B 00 02</u>

Sets the safe value (DO0 – DO1)

A description of the command and response is as follows:

Command:	[Leading 6 bytes]	
	Bytes 00-03	01 02 00 00 (Message Number)
	Bytes 04-05	00 08 (Number of bytes remaining in this frame)
	[Request]	
	Byte 00	01 (Net ID)
	Byte 01	0F (Function Code)
	Bytes 02-03	01 0B (Starting DO Address)
	Bytes 04-05	00 02 (Number of Output Channels)
	Byte 06	01 (Byte Count)
	Byte 07	03 (Output Value)

Response:	[Leading 6 bytes]	
	Bytes 00-03	01 02 00 00 (Message Number)
	Bytes 04-05	00 06 (Number of bytes remaining in this frame)
	[Response]	
	Byte 00	01 (Net ID)
	Byte 01	0F (Function Code)
	Bytes 02-03	01 0B (Starting DO Address)
	Bytes 04-05	00 02 (Number of Input Channels)

16(0x10) Preset Multiple Registers (Write AOs)

This function code is used to set multiple holding registers that are used to store the configuration values for the PETL/tET/tPET module.

[Request]

Byte	Description	Size	Value
00	Net ID (Station Number)	1 Byte	1 to 247
01	Function Code	1 Byte	0x10
02-03	Starting AO Address	2 Bytes	Refer to the Modbus Address Table for the PETL/tET/tPET series. (Section 6.3 Modbus Register Table) Byte 02 = high byte Byte 03 = low byte
04-05	Number of 16-bit Registers (Channels)	2 Bytes	Word Count. Byte 04 = high byte Byte 05 = low byte
06	Byte Count	1 Byte	n = Points x 2 Bytes
07	Register Values	n Bytes	Register Values. n = 2; Byte 03 = high byte Byte 04 = low byte n = m; Byte 03 = high byte Byte 04 = low byte Byte m+1 = high byte Byte m+2 = low byte

[Response]

Byte	Description	Size	Value
00	Net ID (Station Number)	1 Byte	1 to 247
01	Function Code	1 Byte	0x10
02-03	Starting AO Address	2 Bytes	The value is the same as Bytes 02-03 of the Request
04-05	Number of 16-bit Registers (Channels)	2 Bytes	The value is the same as Bytes 04-05 of the Request

[Error Response]

Byte	Description	Size	Value
00	Net ID (Station Number)	1 Byte	1 to 247
01	Function Code	1 Byte	0x90
02	Exception Code	1 Byte	Refer to the Modbus Standard Specifications for more details.

Example: Function 16 (0x10), Write AOs

	[Leading 6 bytes]	[Request]
Command:	<u>01 02 00 00 00 0B</u>	<u>01 10 00 32 00 01 02 03 E8 00 00</u>
	[Leading 6 bytes]	[Response]
Response:	<u>01 02 00 00 00 06</u>	<u>01 10 00 32 00 01</u>

Sets the Preset value for the digital counter

A description of the command and response is as follows:

Command:	[Leading 6 bytes]	
	Bytes 00-03	01 02 00 00 (Message Number)
	Bytes 04-05	00 0B (Number of bytes remaining in this frame)
	[Request]	
	Byte 00	01 (Net ID)
	Byte 01	10 (Function Code)
	Bytes 02-03	00 32 (Starting AO Address)
	Bytes 04-05	00 01 (Number of 16-bit Registers)
	Byte 06	02 (Byte Count)
	Bytes 07-10	03 E8 00 00 (Preset Value for the digital counter)

Response:	[Leading 6 bytes]	
	Bytes 00-03	01 02 00 00 (Message Number)
	Bytes 04-05	00 06 (Number of bytes remaining in this frame)
	[Response]	
	Byte 00	01 (Net ID)
	Byte 01	10 (Function Code)
	Bytes 02-03	00 32 (Starting AO address)
	Bytes 04-05	00 01 (Word Count)

6.3 Modbus Register Table

Data from 16-bit registers is transmitted in high-byte first order. For example: 0x0A0B ==> 0x0A, 0x0B. Data from 32-bit registers is transmitted as two 16-bit registers, and is in low-word first order. For example: 0x0A0B0C0D ==> 0x0C, 0x0D, 0x0A, 0x0B.

6.3.1 Common Functions

➤ **0xxxx: DO Address (Base 0)**

Starting Address	Points	Description	Bits per Point	Range	Access Type
127 (0x7F)	1	Restores all default web settings	1	1 = Restore	W (Pulse)
128 (0x80)	1	Default ID Settings	1	1 = Restore	W (Pulse)
133 (0x85)	1	Reboots the PETL/tET/tPET module	1	1 = Reboot	W (Pulse)
Remarks	“W”: Write				

➤ **3xxxx: AI address (Base 0)**

Starting Address	Points	Description	Bits per Point	Range	Access Type
151 (0x97)	1	Firmware Version	16	“123” denotes that the version is 1.2.3	R
158 (0x9E)	1	Modbus Communication Status	16	0 = No Error 1 = Timeout	R
160 (0xA0)	1	Pair-Connection Status	16	0 = Normal 1 = Timeout 2 = Disconnected	R
Remarks	“R”: Read				

➤ **4xxxx: AO Address (Base 0)**

Starting Address	Points	Description	Bits per Point	Range	Access Type
255 (0xFF)	1	CPU Reset Status	16	1 = Reset at Power-on 2 = Reset by the WDT 3 = Reset using the reset command	R/W
257 (0x101)	1	Sets the Host Watchdog Timer (WDT)	16	<5: Disabled 5 to 65535 : Enabled (units: seconds) 0 : Default If the PETL/tET/tPET module loses communication with the host PC for more than the period defined in the WDT settings, the DO channels will revert to their safe values and the Host WDT Events Counter will be increased by one.	R/W/F
258 (0x102)	1	Host WDT Events	16	Denotes how many Host WDT Events have occurred since the last CPU reset	R/W
259 (0x103)	1	Module Name	16	Module Name	R
263 (0x107)	1	Sets the TCP Timeout Value	16	<5: Disabled 5 to 65535 : Enabled (units: seconds) 0 :Default	R/W/F
264 (0x108)	1	Sets the System Timeout Value	16	< 30 : Disabled 30~65535 : Enabled (unit: second) 0 :default	R/W/F
Remarks	<p>“R”: Read; “W”: Write; “F”: Setting is recorded in flash as default. Warning: Frequent writing to the Flash can cause it to become corrupt.</p>				

6.3.2 Specific Functions

The nDI and nDO parameters for each PETL/tET/tPET series module used in the following Modbus Address Tables are as follows:

Model Name		Number of DO Channels (nDO)	Number of DI Channels (nDI)
Non-PoE Series	PoE Series		
tET-P6	tPET-P6	0	6
tET-PD6	tPET-PD6	0	6
tET-C4	tPET-C4	4	0
tET-A4	tPET-A4	4	0
tET-P2C2	tPET-P2C2	2	2
tET-P2A2	tPET-P2A2	2	2
tET-P2POR2	tPET-P2POR2	2	2
tET-PD2POR2	tPET-PD2POR2	2	2
tET-P2R2	tPET-P2R2	2	2
tET-PD2R1	tPET-PD2R1	1	2
-	PETL-7060	6	6

➤ 0xxxx: DO address (Base 0)

Starting Address	Points	Description	Bits per Point	Range	Access Type
0 (0x00)	1 to nDO	Digital Output Channels	1	0 = Off 1 = On	R/W
32 (0x20)	1	Clears the status of all high latched DI Channels	1	1 = Clear	W
33 (0x21)	1	Clears the status of all low latched DI Channels	1	1 = Clear	W
34 (0x22)	1 to nDI	Clears the high speed digital counter for all DI Channels	1	1 = Clear	W
60 (0x3C)	1	Saves specific data to Flash (The access type for some registers is labeled with an "E")	1	1 = Clear	W
100 (0x64)	1 to nDO	Enables the PWM for all DO Channels	1	0 = Off 1 = On (Default= 0)	R/W

150 (0x96)	1	Enables the high and low latches for all DI Channels	1	0 = Disable 1 = Enable (Default= 0)	R/W/F
151 (0x97)	1 to nDI	Enables the high speed digital counter for all DI Channels	1	0 = Disable 1 = Enable (Default= 0)	R/W/F
190 (0xBE)	1 to nDI	Enables frequency measurement for all DI Channels	1	0 = Disable 1 = Enable (Default= 0)	R/W/F
235 (0xEB)	1 to nDO	Sets the Power-on value for all DO Channels	1	0 = Off 1 = On (Default= 0)	R/W/F
267 (0x10B)	1 to 1DO	Sets the Safe value for all DO Channels	1	0 = Off 1 = On (Default= 0)	R/W/F
Remarks	<p>“R”: Read “W”: Write “F”: Settings are recorded in flash by default “E”: After writing DO[60] register, the data will be stored in flash. Warning: Frequency writing to the Flash can cause it to become corrupt.</p>				

 **Note**

Because of the characteristics of the relay functions, it is recommended that the PWM on t(P)ET-P(D)2POR2/ t(P)ET-P2R2/ t(P)ET-PD2R1/ PETL-7060 series modules (i.e., modules with relay functions) is not used for extended periods of time.

➤ **1xxxx: DI address (Base 0)**

Starting Address	Points	Description	Bits per Point	Range	Access Type
0 (0x00)	1 to nDI	The status of all Digital Input Channels	1	0 = Off 1 = On	R
32 (0x20)	1 to nDI	The status of all high latched DI Channels	1	0 = None 1 = Latched	R
64 (0x40)	1 to nDI	The status of all low latched DI Channels	1	0 = None 1 = Latched	R
Remarks	“R”: Read				

268 (0x10C)	1 to nDO	The Min-Switching Time for all DO Channels	16	1 to 65535 second	R/W/F
284 (0x11C)	1 to nDO	The Auto-off Time for all DO Channels	16	1 to 65535 second	R/W/F
Remarks	<p>“R”: Read “W”: Write “F”: Settings are recorded in flash by default “E”: After writing the DO[60] register, the data will be stored in flash. Warning: Frequent writing to the Flash can cause it to become corrupt.</p>				

7. Related Tools

7.1 LabVIEW

LabVIEW is a system-design platform and development environment and is ideal for acquiring, analyzing, and presenting data. LabVIEW provides a graphical development environment that allows you to drag and drop pre-built objects to quickly create data acquisition, instrumentation and control systems, thereby boosting productivity and reducing development time. LabVIEW makes it possible to quickly create user interfaces that enable interactive control of software systems then specify the functionality of your system, by simply assembling a block diagram, which is a natural design notation for scientists and engineers.

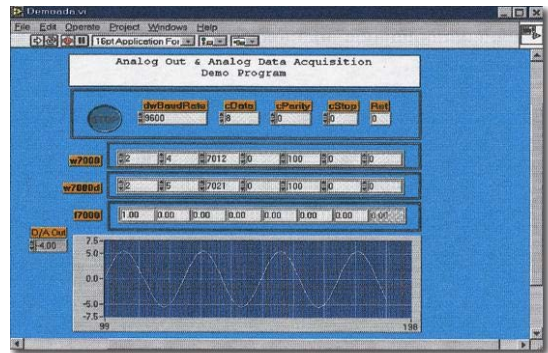

A document that describes how to link LabVIEW to a PETL/tET/tPET device using the Modbus protocol can be found at:

http://ftp.icpdas.com/pub/cd/6000cd/napdos/et7000/document/application/labview/labview_modbus_eng.pdf

7.2 OPC Server

OPC (OLE for Process Control) was the first standard resulting from the collaboration of a number of leading worldwide automation suppliers working in cooperation with Microsoft. Originally based on Microsoft's OLE COM (Component Object Model) and DCOM (Distributed Component Object Model) technologies, the specification defines a standard set of objects, interfaces and methods for use in process control and manufacturing automation applications to facilitate interoperability.

A wide range of different mechanisms are provided by various vendors that allow access to a variety of devices via specific applications. However, if an OPC server is provided for the device, other applications will also be able to access the device via the OPC interface.

7.3 SCADA

SCADA stands for Supervisor Control and Data Acquisition and is a PC-based production automation and control system.

SCADA is widely used in many fields, including power generation, water systems, the oil industry, the chemical, and the automobile industry. Different fields require different functions, but they all have the same common requirements:

- ✓ Graphical interface
- ✓ Process mimicking
- ✓ Real-time and historical trend data
- ✓ Alarm systems
- ✓ Data acquisition and recording
- ✓ Data analysis
- ✓ Report generation

Accessing the PETL/tET/tPET Series Module

SCADA software is able to access PETL/tET/tPET series devices using the Modbus communication protocol without the need for other software drivers.

Popular SCADA Software

Some of the more popular SCADA software includes **Citect, ICONICS, iFIX, InduSoft, Intouch, Entivity Studio, Entivity Live, Entivity VLC, Trace Mode, Wizcon, and Wonderware**, etc.

In the following sections, three popular brands of SCADA software are introduced, together with detailed instructions of how to use them to communicate with PETL/tET/tPET series modules using the Modbus TCP protocol.

➤ **InduSoft**

InduSoft Web Studio is a powerful, integrated collection of automation tools that includes all the building blocks needed to develop modern Human Machine Interfaces (HMI), Supervisory Control and Data Acquisition (SCADA) systems, and embedded instrumentation and control applications. InduSoft Web Studio's application runs in native Windows NT, 2000, XP, CE and CE .NET environments and conforms to industry standards such as Microsoft .NET, OPC, DDE, ODBC, XML, and ActiveX.

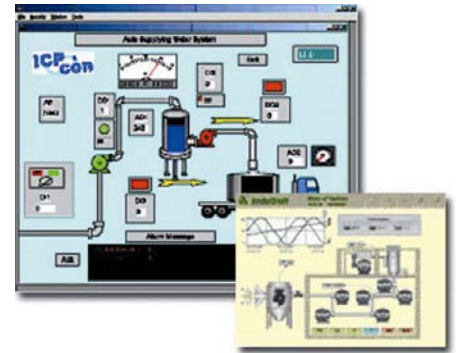

The document describing how to link InduSoft to the PETL/tET/tPET series module using the Modbus protocol is located at:

http://ftp.icpdas.com/pub/cd/6000cd/napdos/et7000/document/application/indusoft/indusoft_modbus_eng.pdf

➤ **Citect**



Citect SCADA is a fully integrated Human Machine Interface (HMI) / SCADA solution that enables users to increase return on assets by delivering a highly scalable, reliable control and monitoring system. Easy-to-use configuration tools and powerful features enable the rapid development and deployment of solutions for applications of any size.

The document describing how to link Citect to the PETL/tET/tPET module using the Modbus protocol is located on

http://ftp.icpdas.com/pub/cd/6000cd/napdos/et7000/document/application/ifix/ifix_mbtcp.pdf

➤ **iFix**



The document describing how to link iFix to the PETL/tET/tPET series module using the Modbus protocol is located at:

http://ftp.icpdas.com/pub/cd/6000cd/napdos/et7000/document/application/citect/citect_mbtcp.pdf

Appendix: Troubleshooting

How do I restore the web password for the module to the factory default password?

The instructions below outline the procedure for resetting the web password to the factory default value.

Note: Be aware that **ALL settings will be restored to the factory default values after the module is reset.**

Step 1 Locate the Init/Run switch that can be found on the top side of the PETL/tET/tPET module and set it to the "Init" position. Reboot the module to **load factory default settings** including default web password.

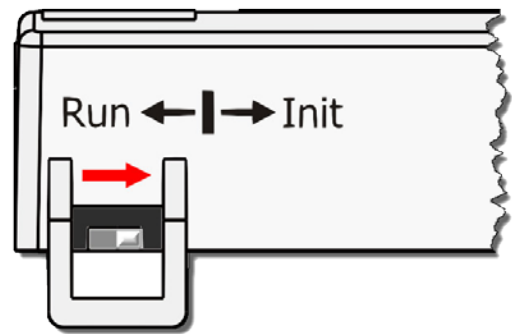

Step 2 Execute either the VxComm Utility or the eSearch Utility to search for any PETL/tET/tPET modules connected to the network. Verify that the PETL/tET/tPET has been reset to the original factory default settings. For example, the module should be shown as having the default IP address, which is 192.168.255.1.

Name	Alias	IP Address	Sub-net Mask	Gateway	MAC Address
tPET-P2POR2_RevB	EtherIO	192.168.255.1	255.255.0.0	192.168.0.1	00:0d:e0:02
WP9000	Compact	10.0.8.75	255.255.255.0	10.0.8.254	00:0D:E0:3F
WP9000	Compact	10.0.8.41	255.255.255.0	10.0.8.254	00:0D:E0:3C
ET-7065/PET-7065	N/A	10.0.8.100	255.255.255.0	10.0.8.254	00:0d:e0:d0
WP8000	WP8000	10.0.8.46	255.255.255.0	10.0.8.254	00:0D:E0:3C

Step 3 Double-click the name of the module to open the Configure Server (UDP) dialog box, and modify the basic settings as necessary, e.g., the IP, Mask and Gateway addresses, and then click the "OK" button to **save the new settings**.

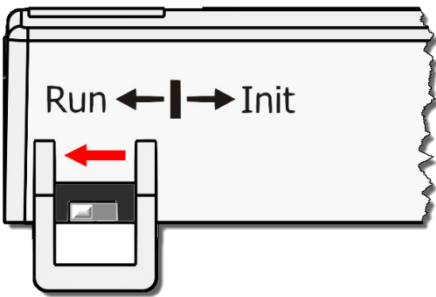
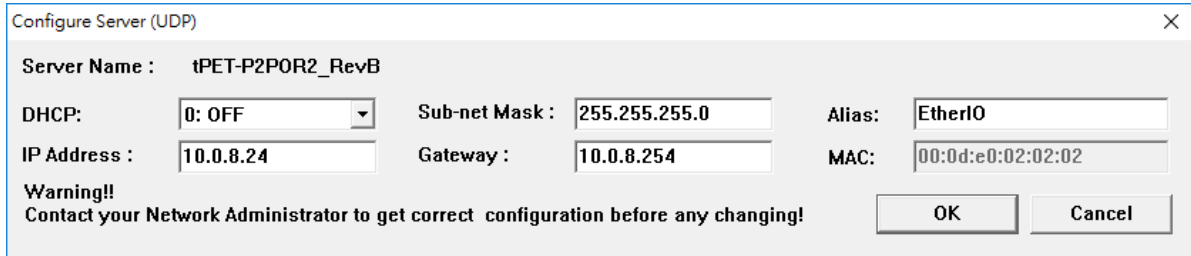

Step 4 Reset the Init/Run switch on the PETL/tET/tPET module to the "Run" position and reboot the device.

Step 5 Log in to the web configuration pages for the PETL/tET/tPET module, using the default web password, "Admin".

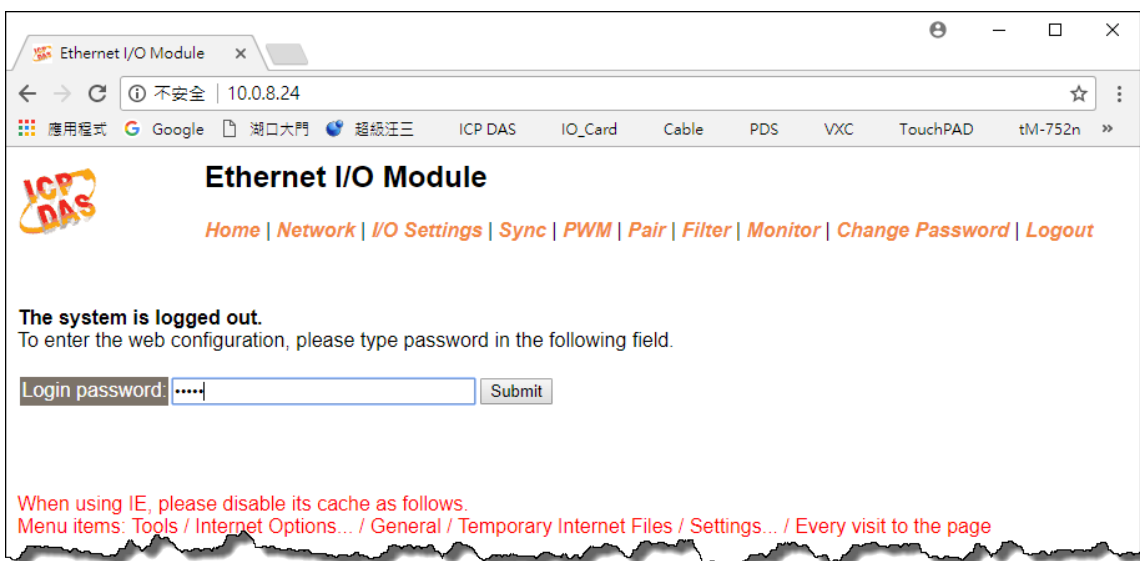

Appendix B: Revision History

This chapter provides revision history information to this document.

The table below shows the revision history.

Revision	Date	Description
1.0	Mar. 2011	Initial issue
1.6	July 2013	<ol style="list-style-type: none">1. Added the software and hardware information about the tET/tPET-PD6.2. Added the software and hardware information about the tET/tPET-PD2POR2.3. Added the software and hardware information about the tET/tPET-PD2R1.
2.2	Aug.2017	<ol style="list-style-type: none">4. Updated the information about the Firmware Version v1.4.6 [Jun.16, 2017] in Chapter 4 Web Configuration.5. Added Chapter Appendix A: Troubleshooting.6. Added Chapter Appendix B: Revision History.
2.2.1	Mar.2018	Remove the package CD