



Highlight Information

- Linux kernel 2.6.19 Inside
- Embedded Service: Web Server, FTP Server, Telnet Server, SSH Server
- Power PXA270 CPU: 32-bit & 520 MHz
- 64 MB Flash, 128 MB SDRAM
- Built-in Ethernet, USB, RS-232, RS-485 Ports
- Built-in 800 × 600 VGA Port (for LP-51x1 and LP-54x1)
- Built-in 1024 × 768 VGA Port (for LP-52x1 and LP-55x1)
- Built-in Audio with Microphone-In and Earphone-Out (for LP-53/54/55x1)
- I/O Expansion Board Optional
- Operating Temperature: -25 ~ +75 °C



Introduction

LinPAC-5000 is the new generation Linux based PAC of ICP DAS. It equips a PXA270 CPU (520 MHz) running a Linux kernel 2.6.19 operating system, various connectivity (VGA, USB, Ethernet, RS-232/RS-485 and audio ports) and I/O expansion board optional for high performance parallel I/O modules (high profile I-8K series) and serial-type I/O modules (high profile I-87K I/O modules) or implement various I/O functions such as DI, DO, A/D, D/A, Timer/Counter, UART, flash memory, battery backup SRAM, etc.

The LP-5000 had the advantages of good control system. These advantages include: stability, small core size of kernel, I/O expansion board optional, support Web service (Web/FTP/Telnet/SSH server), support multiple development environment (LinPAC SDK for Linux and Windows environment by GNU C language, JAVA, GUI software), etc. They give you all of the best features of both traditional PLCs and Linux capable PCs. That's the most powerful and flexible embedded control system.

Applications

Field Bus I/O Expansion

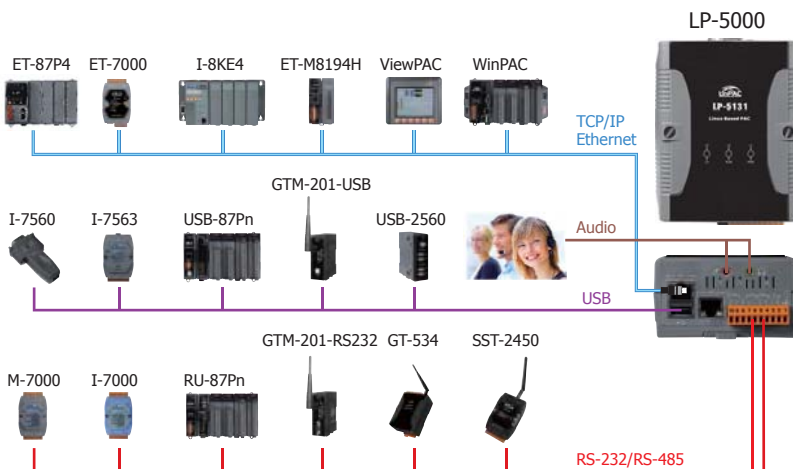

Features

Software

- OS: Linux kernel 2.6.19 Inside
- Development Environment
 - Provide LinPAC SDK for Windows & Linux Environment by GNU C Language
 - Support JAVA: JVM, JIOD (Java I/O Driver)
 - Support GUI: Using GTK+ Library
- Built-in Server
 - Web Server, FTP Server, Telnet Server, SSH Server
- Supported Communication
 - Wireless LAN, PPP over Modem, GPRS, Ethernet
 - VxComm
 - Expansion Serial Ports
 - Support USB to Serial Converter
 - Support DCON and Modbus Protocols
- Security:
 - Firewall, NAT, Unique Serial Number, VPN

Hardware

- PXA270 CPU (32-bit & 520 MHz)
- 128 MB SDRAM & 64 MB Flash
- Built-in 800 × 600 VGA Port (for LP-51x1 and LP-54x1)
- Built-in 1024 × 768 VGA Port (for LP-52x1 and LP-55x1)
- 64-bit Hardware Serial Number for Software Protection
- Built-in Ethernet, USB, RS-232, RS-485 Ports
- Built-in Audio with Microphone-In and Earphone-Out (for LP-53/54/55x1)
- Rich I/O Expansion Ability
- I/O Expansion Board Optional
- Operating Temperature: -25 ~ +75 °C

Specifications

Models	LP-5131	LP-5231	LP-5331	LP-5431	LP-5531	LP-5141	LP-5241	LP-5341	LP-5441	LP-5541
System Software										
OS	Linux kernel 2.6.19									
Embedded Service	Web Server, FTP Server, Telnet Server, SSH Server									
SDK Provided	Standard LinPAC SDK for Windows and Linux by GNU C language									
CPU Module										
CPU	PXA270 or compatible (32-bit and 520 MHz)									
SDRAM	128 MB									
NVRAM	31 Byte (Battery backup, data valid up to 10 years)									
Flash	64 MB									
EEPROM	16 KB Data Retention: 40 years; 1,000,000 erase/write cycles									
Expansion Flash Memory	microSD socket with one 2 GB microSD card (support up to 16 GB microSDHC card)									
RTC (Real Time Clock)	Provide seconds, minutes, hours, day of week/month, month and year, valid from 1980 to 2079									
64-bit Hardware Serial Number	Yes									
Dual Watchdog Timers	Yes									
LED Indicator	3 Dual-Color LEDs (PWR, RUN, L1 ~ L4; RUN, L1 ~ L4 for user programmable)									
Rotary Switch	Yes (0 ~ 9)									
VGA & Communication Ports										
VGA	Yes 800 × 600	Yes 1024 × 768	-	Yes 800 × 600	Yes 1024 × 768	Yes 800 × 600	Yes 1024 × 768	-	Yes 800 × 600	Yes 1024 × 768
Ethernet	RJ-45 x 1, 10/100 Base-TX (Auto-negotiating, Auto MDI/MDI-X, LED indicators)					RJ-45 x 2, 10/100 Base-TX (Auto-negotiating, Auto MDI/MDI-X, LED indicators)				
USB 1.1 (host)	2					1				
Audio Port (Microphone-In and Earphone-Out)	-	-	1	1	1	-	-	1	1	1
COM 1	RS-232 (Rx/D, Tx/D and GND); Non-isolated									
COM 2	RS-485 (D2+, D2-); 2500 V _{oc} ; isolated									
COM 3	RS-232 (Rx/D, Tx/D and GND); Non-isolated									
I/O Expansion										
I/O Expansion Bus	I/O expansion board optional									
Mechanical										
Dimensions (W x L x H)	91 mm x 132 mm x 52 mm									
Installation	DIN-Rail									
Environmental										
Operating Temperature	-25 ~ +75 °C									
Storage Temperature	-30 ~ +80 °C									
Ambient Relative Humidity	10 ~ 90% RH (non-condensing)									
Power										
Input Range	+10 ~ +30 V _{oc}									
Isolation	1 kV									
Consumption	4.8 W (0.2 A @ 24 V _{oc})	4.8 W (0.2 A @ 24 V _{oc})	6 W (0.25 A @ 24 V _{oc})	6 W (0.25 A @ 24 V _{oc})	6 W (0.25 A @ 24 V _{oc})	4.8 W (0.2 A @ 24 V _{oc})	4.8 W (0.2 A @ 24 V _{oc})	6 W (0.25 A @ 24 V _{oc})	6 W (0.25 A @ 24 V _{oc})	6 W (0.25 A @ 24 V _{oc})

Appearance

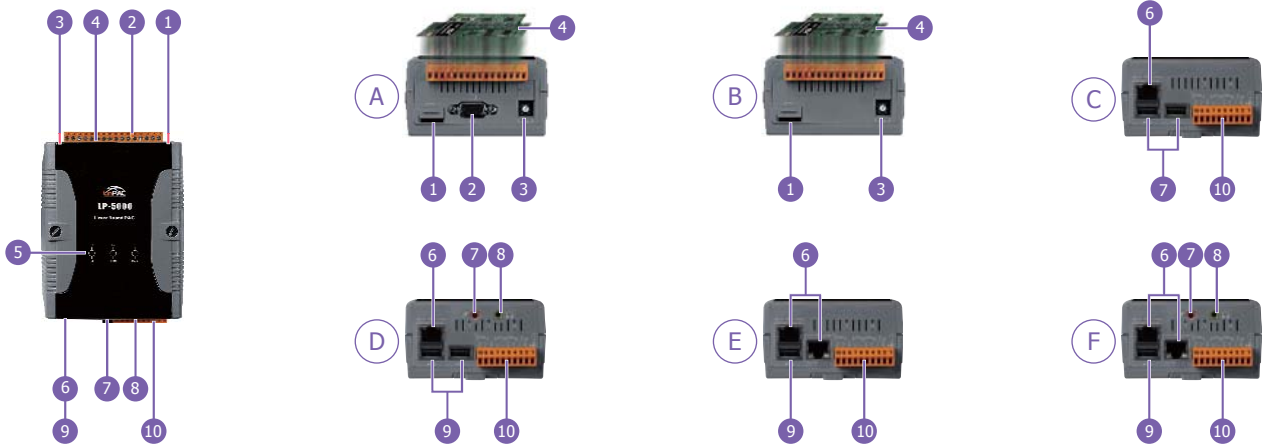

1	microSD Socket	2	VGA Port	3	Operating Modes Selector
4	XW-Board (optional)	5	LED Indicator	6	Ethernet Port
7	Microphone-In	8	Earphone-Out	9	USB Port
10	COM Port				

LP-5131	Include: A, C	LP-5231	Include: A, C	LP-5331	Include: B, D	LP-5431	Include: A, D	LP-5531	Include: A, D
LP-5141	Include: A, E	LP-5241	Include: A, E	LP-5341	Include: B, F	LP-5441	Include: A, F	LP-5541	Include: A, F

Pin Assignments

LP-5141/5241

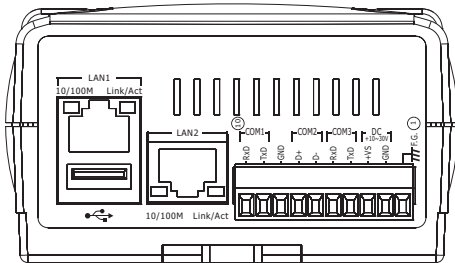

LP-5341/5441/5541

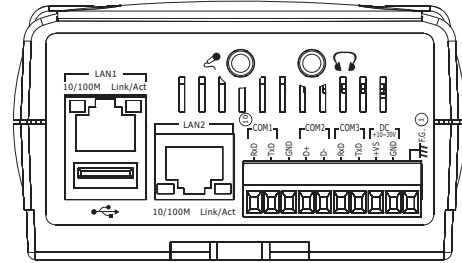

LP-5131/5231

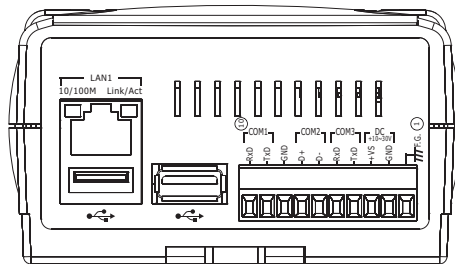

LP-5331/5431/5531

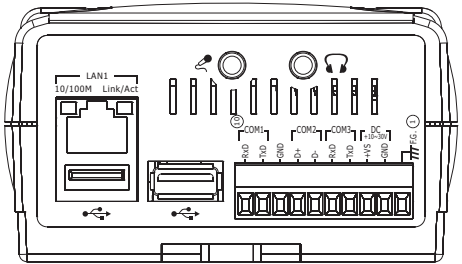

LP-51x1/52x1/54x1/55x1

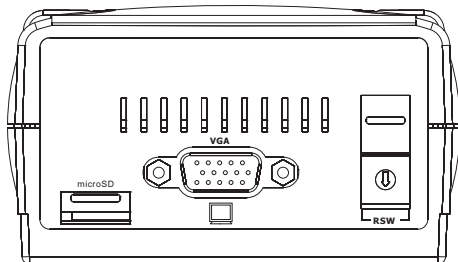

LP-5331/5341

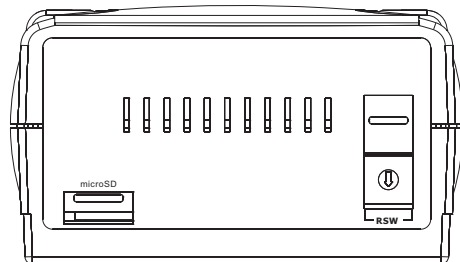

▣ Dimensions (Unit: mm)

LP-5000

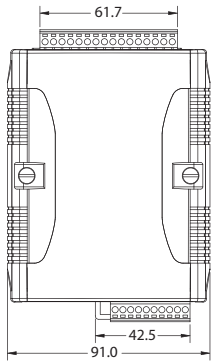

Front View

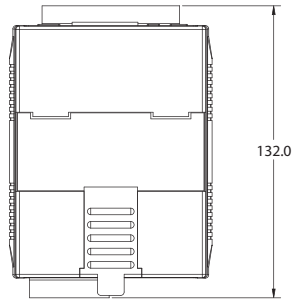

Back View

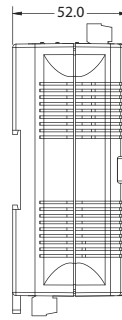

Left Side View

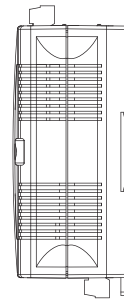

Right Side View

LP-5331/5341

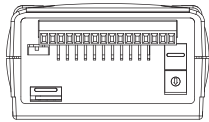

Top View

LP-51x1/52x1/54x1/55x1

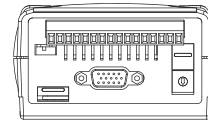

Top View

LP-5131/5231

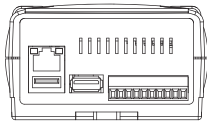

Bottom View

LP-5331/5431/5531

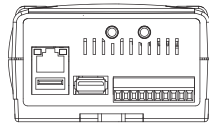

Bottom View

LP-5141/5241

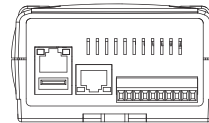

Bottom View

LP-5341/5441/5541

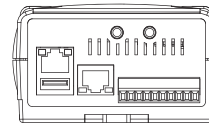

Bottom View

▣ Ordering Information

LP-5131-EN CR	Standard LinPAC-5000 with 800 × 600 VGA port (English Version of OS) (RoHS)
LP-5231-EN CR	Standard LinPAC-5000 with 1024 × 768 VGA port (English Version of OS) (RoHS)
LP-5331-EN CR	Standard LinPAC-5000 with audio port (English Version of OS) (RoHS)
LP-5431-EN CR	Standard LinPAC-5000 with 800 × 600 VGA port and audio port (English Version of OS) (RoHS)
LP-5531-EN CR	Standard LinPAC-5000 with 1024 × 768 VGA port and audio port (English Version of OS) (RoHS)
LP-5141-EN CR	Standard LinPAC-5000 with 800 × 600 VGA port (English Version of OS) (RoHS)
LP-5241-EN CR	Standard LinPAC-5000 with 1024 × 768 VGA port (English Version of OS) (RoHS)
LP-5341-EN CR	Standard LinPAC-5000 with audio port (English Version of OS) (RoHS)
LP-5441-EN CR	Standard LinPAC-5000 with 800 × 600 VGA port and audio port (English Version of OS) (RoHS)
LP-5541-EN CR	Standard LinPAC-5000 with 1024 × 768 VGA port and audio port (English Version of OS) (RoHS)

▣ Accessories

DP-660	24 V _{dc} /2.5 A, 60 W and 5 V _{dc} /0.5 A, 2.5 W Power Supply with DIN-Rail Mounting
DP-1200	24 V _{dc} /5.0 A, 120 W Power Supply with DIN-Rail Mounting
MDR-20-24	24 V _{dc} /5.0 A, 120 W Power Supply with DIN-Rail Mounting
MDR-60-24	24 V _{dc} /2.5 A, 60 W Power Supply with DIN-Rail Mounting